

# High-Efficiency, 8A, Current-Mode Synchronous Step-Down Switching Regulator with VID Control

## General Description

The MAX15109 high-efficiency, current-mode, synchronous step-down switching regulator with integrated power switches deliver up to 8A of output current. This regulator operates from 2.7V to 5.5V and provides four output voltages using two VID control inputs.

This IC utilizes a current-mode control architecture with a high gain transconductance error amplifier. The current-mode control architecture facilitates easy compensation design and ensures cycle-by-cycle current limit with fast response to line and load transients.

This regulator offers skip-mode functionality to reduce current consumption and achieve a higher efficiency at light loads. The low  $R_{DS(ON)}$  integrated switches ensure high efficiency at heavy loads while minimizing critical inductance, making the layout design a much simpler task with respect to discrete solutions. The high switching frequency (1MHz), along with the PWM current-mode architecture allows for a compact, all-ceramic capacitor design.

The IC features a capacitor-programmable slew-rate control to reduce input current at the startup and when the output changes state under VID control. Internal control circuitry ensures safe-startup into a prebiased output. Power sequencing is controlled with the enable input and power-good output.

The IC is available in a 20-bump (4 x 5 array), 2.5mm x 2mm, WLP package and is fully specified over the -40°C to +85°C temperature range.

## Applications

Distributed Power Systems  
DDR Memory  
Notebook Power

## Features

- ◆ Continuous 8A Output Current
- ◆ Efficiency Over 90%
- ◆  $\pm 1\%$  Accuracy Over Load, Line, and Temperature
- ◆ Operates from a 2.7V to 5.5V Supply
- ◆ VID Control Inputs for Selecting Output Voltage
- ◆ Programmable Slew-Rate Control
- ◆ Safe Startup into Prebiased Output
- ◆ 1MHz Switching Frequency
- ◆ Stable with Low-ESR Ceramic Output Capacitors
- ◆ Enable Input and Power-Good Output for Power-Supply Sequencing
- ◆ Cycle-by-Cycle Overcurrent Protection Faults
- ◆ Fully Protected Against Overcurrent and Overtemperature
- ◆ Input Undervoltage Lockout
- ◆ 20-Bump (4 x 5 Array), 2.5mm x 2mm, WLP Package

## Ordering Information

PART	TEMP RANGE	PIN-PACKAGE
MAX15109EWP+	-40°C to +85°C	20 WLP

+ Denotes a lead(Pb)-free/RoHS-compliant package.

## Typical Operating Circuit

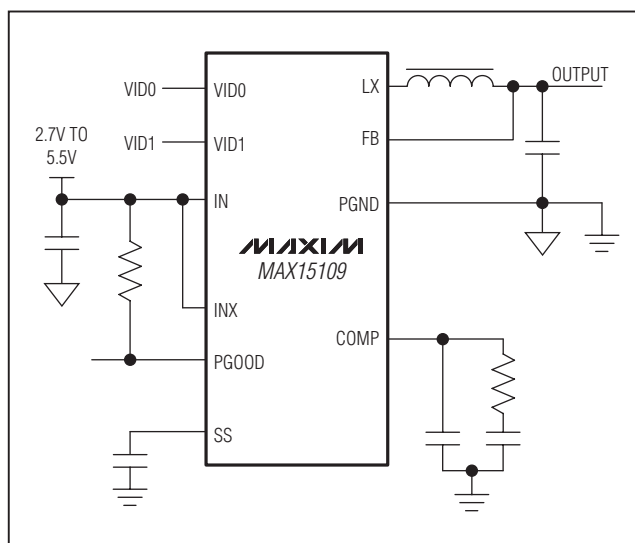

# High-Efficiency, 8A, Current-Mode Synchronous Step-Down Switching Regulator with VID Control

## ABSOLUTE MAXIMUM RATINGS

IN, PGOOD to PGND .....	-0.3V to +6V	Continuous Power Dissipation (T <sub>BOARD</sub> = +70°C)
LX to PGND .....	-0.3V to (V <sub>IN</sub> + 0.3V)	WLP (derate 31.7mW/°C above T <sub>BOARD</sub> = +70°C).....
LX to PGND .....	-1V to (V <sub>IN</sub> + 0.3V) for 50ns	1.27W
EN, COMP, FB, SS, VID0,		Operating Temperature Range .....
VID1 to PGND.....	-0.3V to (V <sub>IN</sub> + 0.3V)	-40°C to +85°C
Continuous LX Current (Note 1).....	-12A to +12A	Operating Junction Temperature (Note 2).....
Output Short-Circuit Duration.....	Continuous	+110°C
		Storage Temperature Range.....
		-65°C to +150°C
		Soldering Temperature (reflow) (Note 3) .....
		+260°C

**Note 1:** LX has internal clamp diodes to PGND and IN. Do not exceed the power dissipation limits of the device when forward biasing these diodes.

**Note 2:** Limit the junction temperature to +110°C for continuous operation at full current.

**Note 3:** The WLP package is constructed using a unique set of package techniques that impose a limit on the thermal profile the device can be exposed to during board-level solder attach and rework. This limit permits only the use of the solder profiles recommended in the industry-standard specification JEDEC 020A, paragraph 7.6, Table 3 for IR/VPR and convection reflow. Preheating is required. Hand or wave soldering is not allowed.

Stresses beyond those listed under "Absolute Maximum Ratings" may cause permanent damage to the device. These are stress ratings only, and functional operation of the device at these or any other conditions beyond those indicated in the operational sections of the specifications is not implied. Exposure to absolute maximum rating conditions for extended periods may affect device reliability.

## ELECTRICAL CHARACTERISTICS

(V<sub>IN</sub> = 5V, C<sub>SS</sub> = 4.7nF, T<sub>A</sub> = T<sub>J</sub> = -40°C to +85°C. Typical values are at T<sub>A</sub> = +25°C, unless otherwise noted.) (Note 4)

PARAMETER	SYMBOL	CONDITIONS	MIN	TYP	MAX	UNITS
IN Voltage Range	V <sub>IN</sub>		2.7		5.5	V
IN Shutdown Supply Current		V <sub>EN</sub> = 0V		0.3	3	μA
IN Supply Current	I <sub>IN</sub>	V <sub>EN</sub> = 5V, V <sub>FB</sub> = 1V, not switching		3.4	6	mA
V <sub>IN</sub> Undervoltage Lockout Threshold		LX starts switching, V <sub>IN</sub> rising		2.6	2.7	V
V <sub>IN</sub> Undervoltage Lockout Hysteresis		LX stops switching, V <sub>IN</sub> falling		200		mV
<b>ERROR AMPLIFIER</b>						
Transconductance	GMV			1.4		mS
Voltage Gain	AVEA			90		dB
Output Voltage Accuracy	V <sub>FB</sub>	Over line, load, and temperature	-1		+1	%
FB Input Bias Current	I <sub>FB</sub>		-100		+100	nA
COMP to Current-Sense Transconductance	G <sub>MOD</sub>			25		A/V
COMP Clamp Low		V <sub>FB</sub> = 1V		0.93		V
Compensation RAMP Valley				1		V
<b>POWER SWITCHES</b>						
High-Side Switch Current-Limit Threshold	I <sub>HSCL</sub>			14		A
Low-Side Switch Sink Current-Limit Threshold				14		A
Low-Side Switch Source Current-Limit Threshold				14		A

# High-Efficiency, 8A, Current-Mode Synchronous Step-Down Switching Regulator with VID Control

MAX15109

## ELECTRICAL CHARACTERISTICS (continued)

( $V_{IN} = 5V$ ,  $C_{SS} = 4.7nF$ ,  $T_A = T_J = -40^{\circ}C$  to  $+85^{\circ}C$ . Typical values are at  $T_A = +25^{\circ}C$ , unless otherwise noted.) (Note 4)

PARAMETER	SYMBOL	CONDITIONS	MIN	TYP	MAX	UNITS
LX Leakage Current		$V_{EN} = 0V$			10	$\mu A$
RMS LX Output Current			8			A
<b>OSCILLATOR</b>						
Switching Frequency	f <sub>SW</sub>		850	1000	1150	kHz
Maximum Duty Cycle	D <sub>MAX</sub>			94		%
Minimum Controllable On-Time				100		ns
<b>ENABLE</b>						
EN Input High Threshold Voltage		$V_{EN}$ rising	1.3			V
EN Input Low Threshold Voltage		$V_{EN}$ falling			0.4	V
EN Input Leakage Current		$V_{EN} = 5V$			1	$\mu A$
<b>VID CONTROL INPUTS</b>						
VID_ High Threshold Voltage		$V_{VID\_}$ rising	0.67			V
VID_ Low Threshold Voltage		$V_{VID\_}$ falling			0.33	V
VID1 Input Leakage Current		$V_{VID1} = 5V$			30	$\mu A$
VID0 Input Leakage Current		$V_{VID0} = 5V$			1	$\mu A$
<b>SOFT-START, PREBIAS</b>						
Soft-Start Current	I <sub>SS</sub>	$V_{SS} = 0.45V$ , sourcing		10		$\mu A$
SS Discharge Resistance	R <sub>SS</sub>	I <sub>SS</sub> = 10mA, sinking		8.5		$\Omega$
SS Prebias Mode Stop Voltage		SS rising		0.58		V
<b>HICCUP</b>						
Number of Consecutive Current-Limit Events to Hiccup				8		Events
Timeout				1024		Clock Cycles
<b>POWER-GOOD OUTPUT</b>						
PGOOD Threshold	PGT	FB rising	VID0	VID1		mV
			0	0	824 853 884	
			0	1	705 729 755	
			1	0	654 677 701	
		1	1	580 602 624		
		FB falling			559 578 600	mV
PGOOD V <sub>OL</sub>		I <sub>PGOOD</sub> = 5mA, V <sub>FB</sub> = 0.5V		22	100	mV
PGOOD Leakage		V <sub>PGOOD</sub> = 5V, V <sub>FB</sub> = 1V			1	$\mu A$
<b>THERMAL SHUTDOWN</b>						
Thermal Shutdown Threshold				+160		$^{\circ}C$
Thermal Shutdown Hysteresis		Temperature falling		25		$^{\circ}C$

**Note 4:** Specifications are 100% production tested at  $T_A = +25^{\circ}C$ . Limits over the operating temperature range are guaranteed by design and characterization.

# High-Efficiency, 8A, Current-Mode Synchronous Step-Down Switching Regulator with VID Control

## Typical Operating Characteristics

(Circuit of Typical Application Circuit,  $T_A = +25^\circ\text{C}$ , unless otherwise noted.)

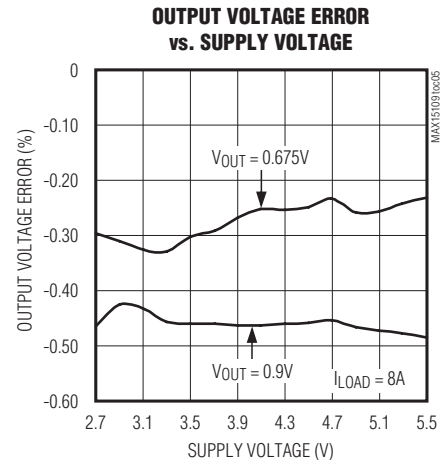
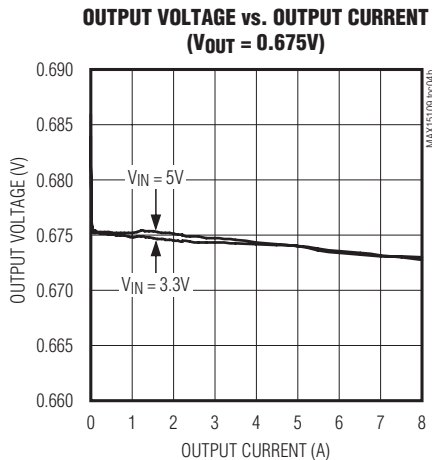
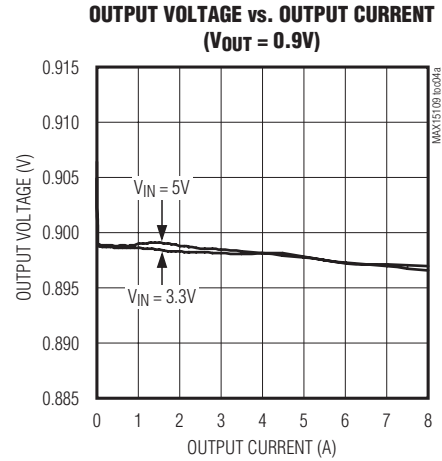
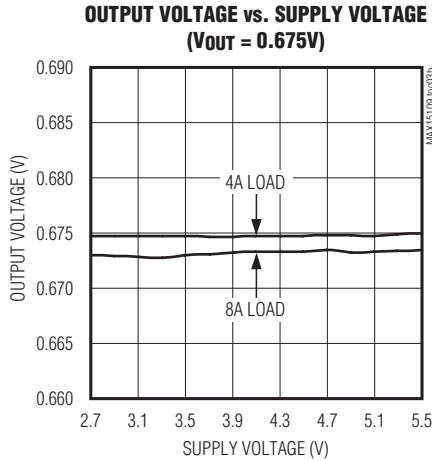
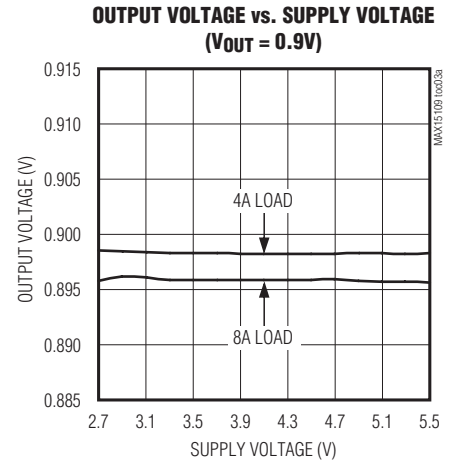
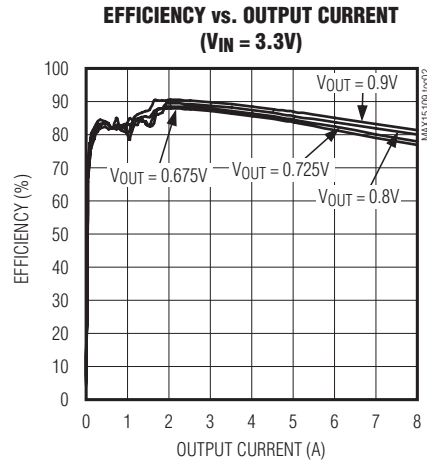
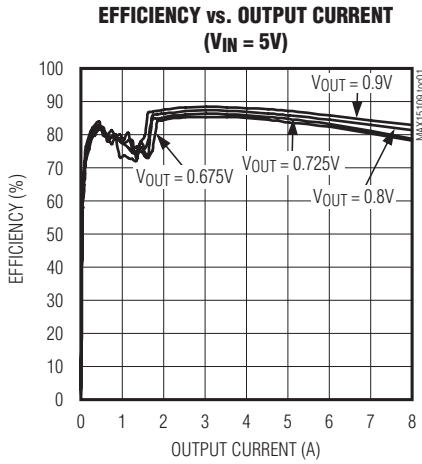

# High-Efficiency, 8A, Current-Mode Synchronous Step-Down Switching Regulator with VID Control

## Typical Operating Characteristics (continued)

(Circuit of Typical Application Circuit,  $T_A = +25^\circ\text{C}$ , unless otherwise noted.)

**LOAD-TRANSIENT RESPONSE**  
( $V_{IN} = 5\text{V}$ ,  $V_{OUT} = 0.9\text{V}$ )

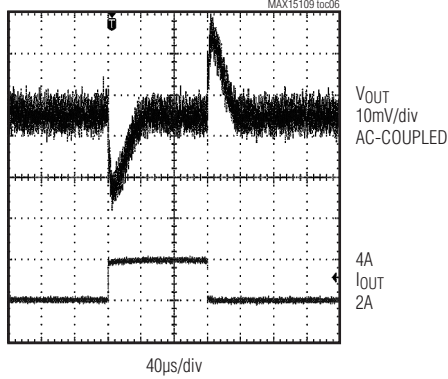

**SWITCHING WAVEFORMS**  
( $I_{OUT} = 8\text{A}$ ,  $V_{IN} = 5\text{V}$ )

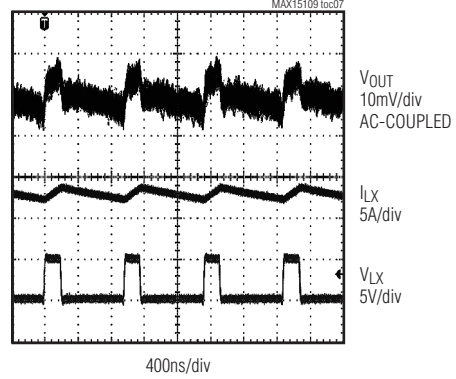

**SWITCHING WAVEFORM IN SKIP MODE**  
( $I_{OUT} = 10\text{mA}$ ,  $V_{IN} = 5\text{V}$ )

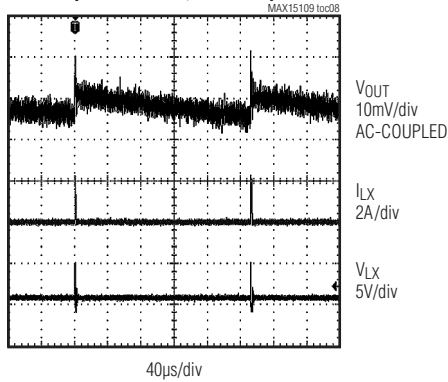

**SHUTDOWN WAVEFORM**  
( $I_{LOAD} = 8\text{A}$ )

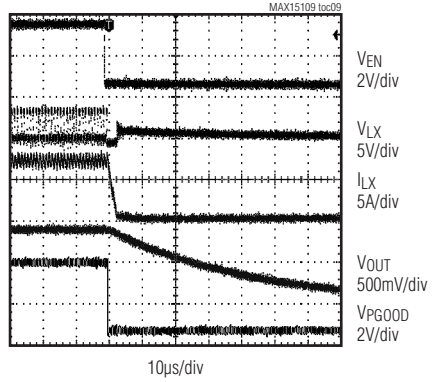

**SOFT-START WAVEFORMS**  
(NO LOAD, SKIP MODE)

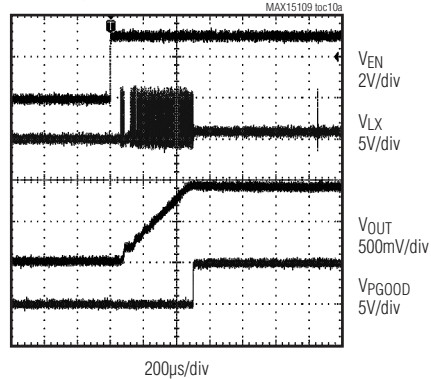

**SOFT-START WAVEFORMS**  
( $I_{LOAD} = 8\text{A}$ )

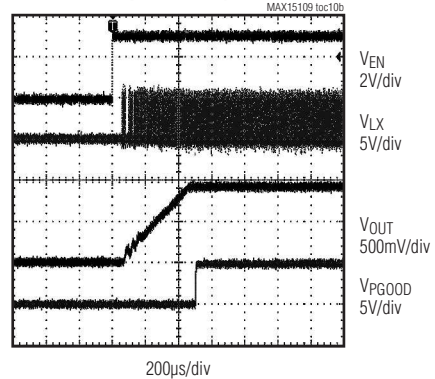

# High-Efficiency, 8A, Current-Mode Synchronous Step-Down Switching Regulator with VID Control

## Typical Operating Characteristics (continued)

(Circuit of Typical Application Circuit,  $T_A = +25^\circ\text{C}$ , unless otherwise noted.)

**0.675V VID TRANSITIONS**  
( $V_{IN} = 3.3\text{V}$ ,  $I_{OUT} = 8\text{A}$ )

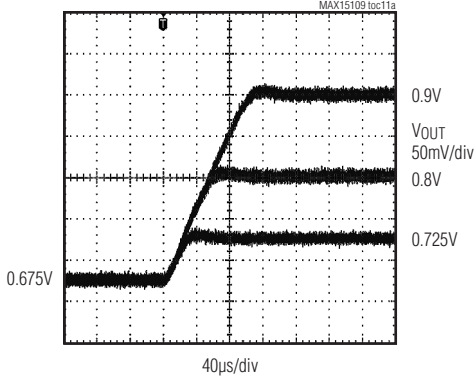

**0.725V VID TRANSITIONS**  
( $V_{IN} = 3.3\text{V}$ ,  $I_{OUT} = 8\text{A}$ )

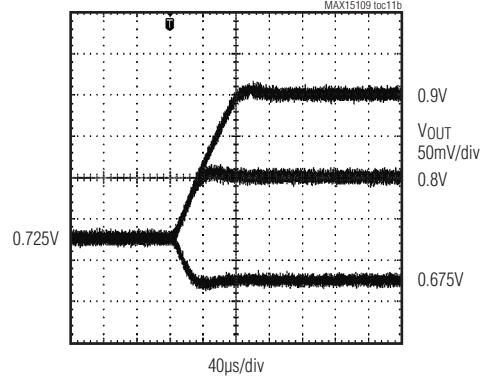

**0.8V VID TRANSITIONS**  
( $V_{IN} = 3.3\text{V}$ ,  $I_{OUT} = 8\text{A}$ )

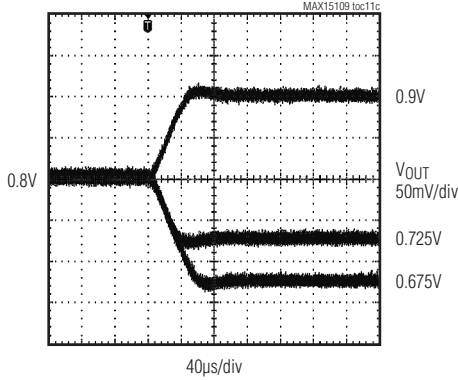

**0.9V VID TRANSITIONS**  
( $V_{IN} = 3.3\text{V}$ ,  $I_{OUT} = 8\text{A}$ )

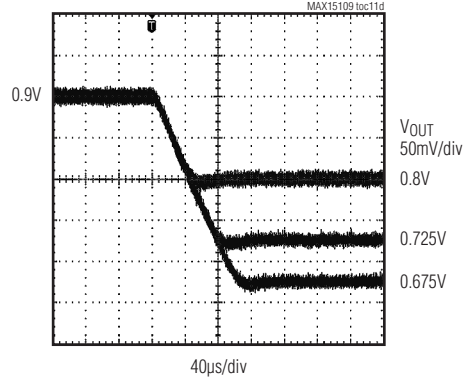

**INPUT SHUTDOWN CURRENT vs. SUPPLY VOLTAGE**

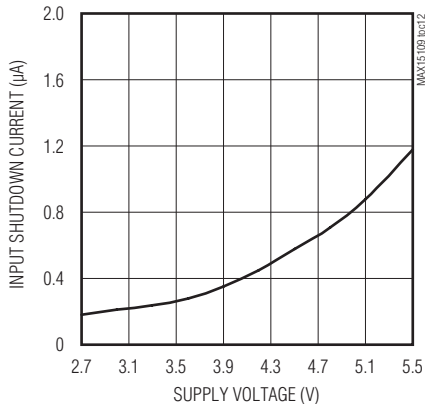

**INPUT CURRENT vs. INPUT VOLTAGE**

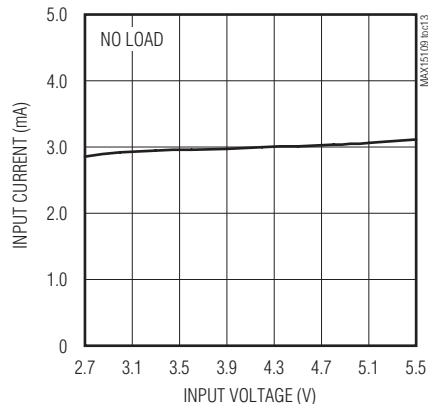

# High-Efficiency, 8A, Current-Mode Synchronous Step-Down Switching Regulator with VID Control

MAX15109

## Typical Operating Characteristics (continued)

(Circuit of Typical Application Circuit,  $T_A = +25^\circ\text{C}$ , unless otherwise noted.)

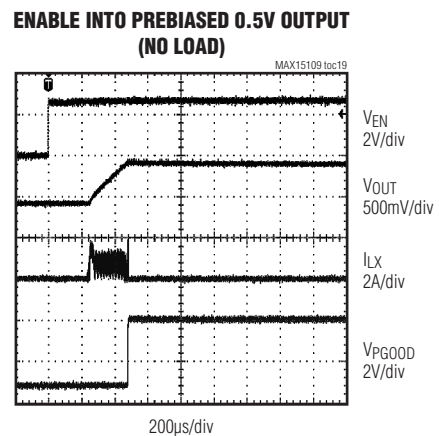
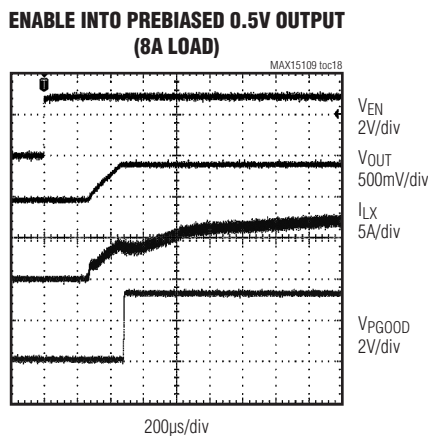
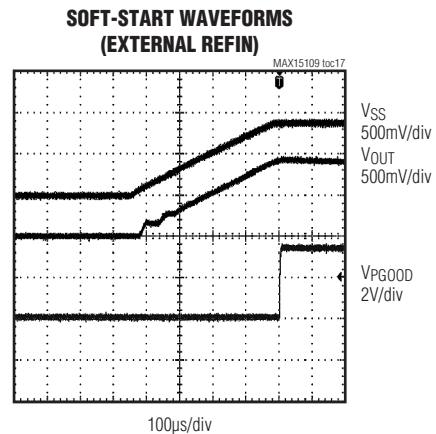
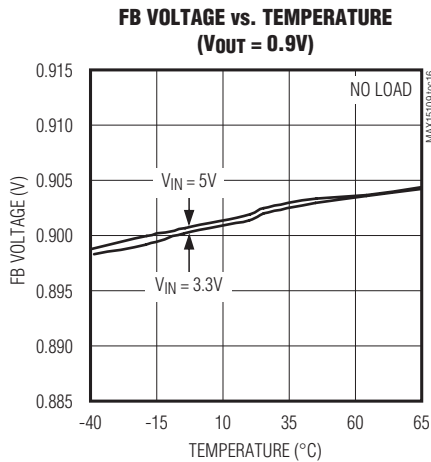
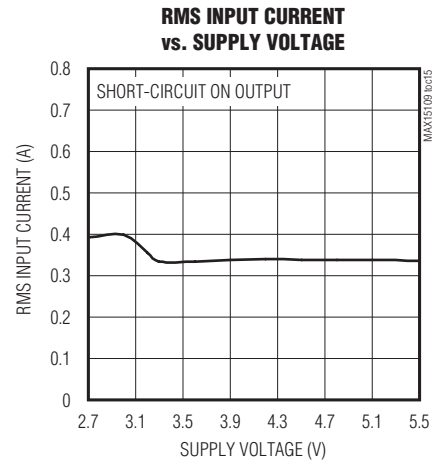
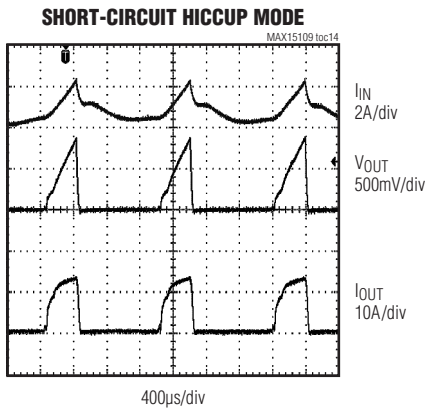

# High-Efficiency, 8A, Current-Mode Synchronous Step-Down Switching Regulator with VID Control

## Bump Configuration

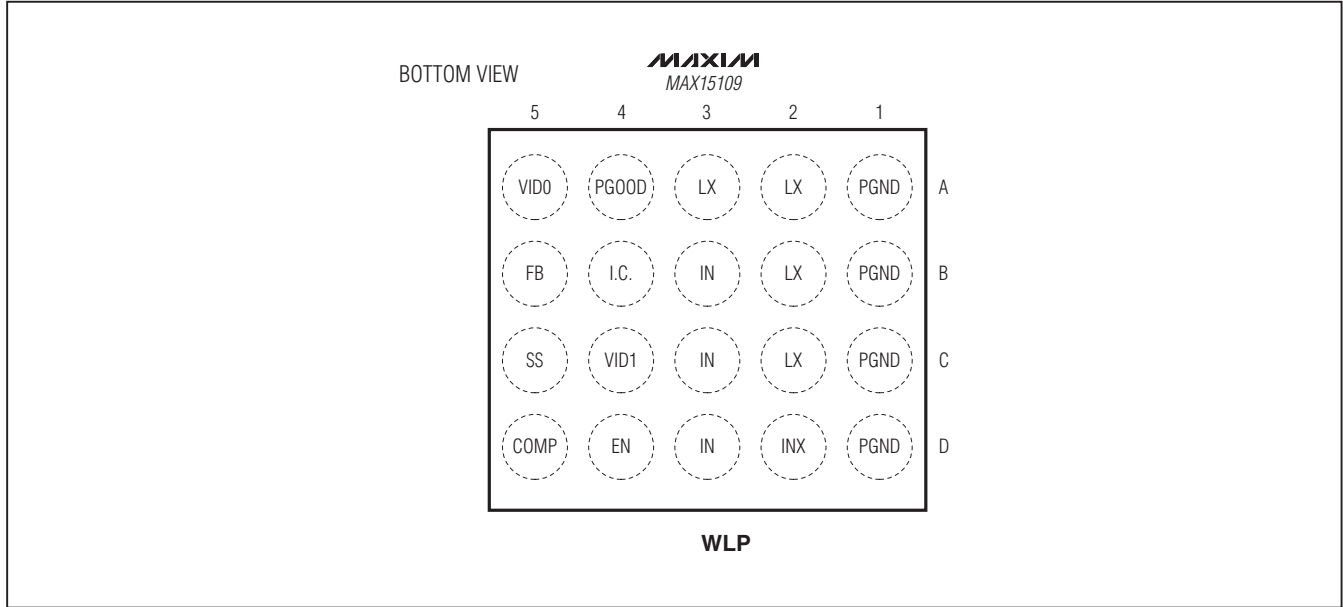

## Bump Description

BUMP	NAME	FUNCTION
A1, B1, C1, D1	PGND	Power Ground. Low-side switch source terminal. Connect PGND and the return terminals of input and output capacitors to the power ground plane.
A2, A3, B2, C2	LX	Inductor Connection. Connect LX to the switching side of the inductor. LX is high impedance when the device is in shutdown mode.
A4	PGOOD	Open-Drain Power-Good Output. PGOOD goes low when V <sub>FB</sub> is below the PGOOD threshold.
A5	VID0	VID0 Logic Input. Use VID0 and VID1 to select output voltage.
B3, C3, D3	IN	Input Power Supply. Input supply range is 2.7V to 5.5V. Bypass IN with a minimum 10μF ceramic capacitor to PGND. See the <i>Typical Application Circuit</i> .
B4	I.C.	Internally Connected. Leave unconnected.
B5	FB	Feedback Input. Connect FB to the sense the output voltage.
C4	VID1	VID1 Logic Input. Use VID0 and VID1 to select output voltage.
C5	SS	Soft-Start and VID Transition Timing Control. Connect a capacitor from SS to PGND to set the startup time and the output voltage transition timing. See the <i>Output Voltage Transition Timing</i> section for details.
D2	INX	Input Power Pin for Control Section. Connect to IN.
D4	EN	Enable Input. EN is a digital input that turns the regulator on and off. Drive EN high to turn on the regulator. Connect to IN for always-on operation.
D5	COMP	Error Amplifier Output. Connect compensation network from COMP to signal ground (SGND). See the <i>Compensation Design Guidelines</i> section.



# High-Efficiency, 8A, Current-Mode Synchronous Step-Down Switching Regulator with VID Control

## Functional Diagram

MAX15109

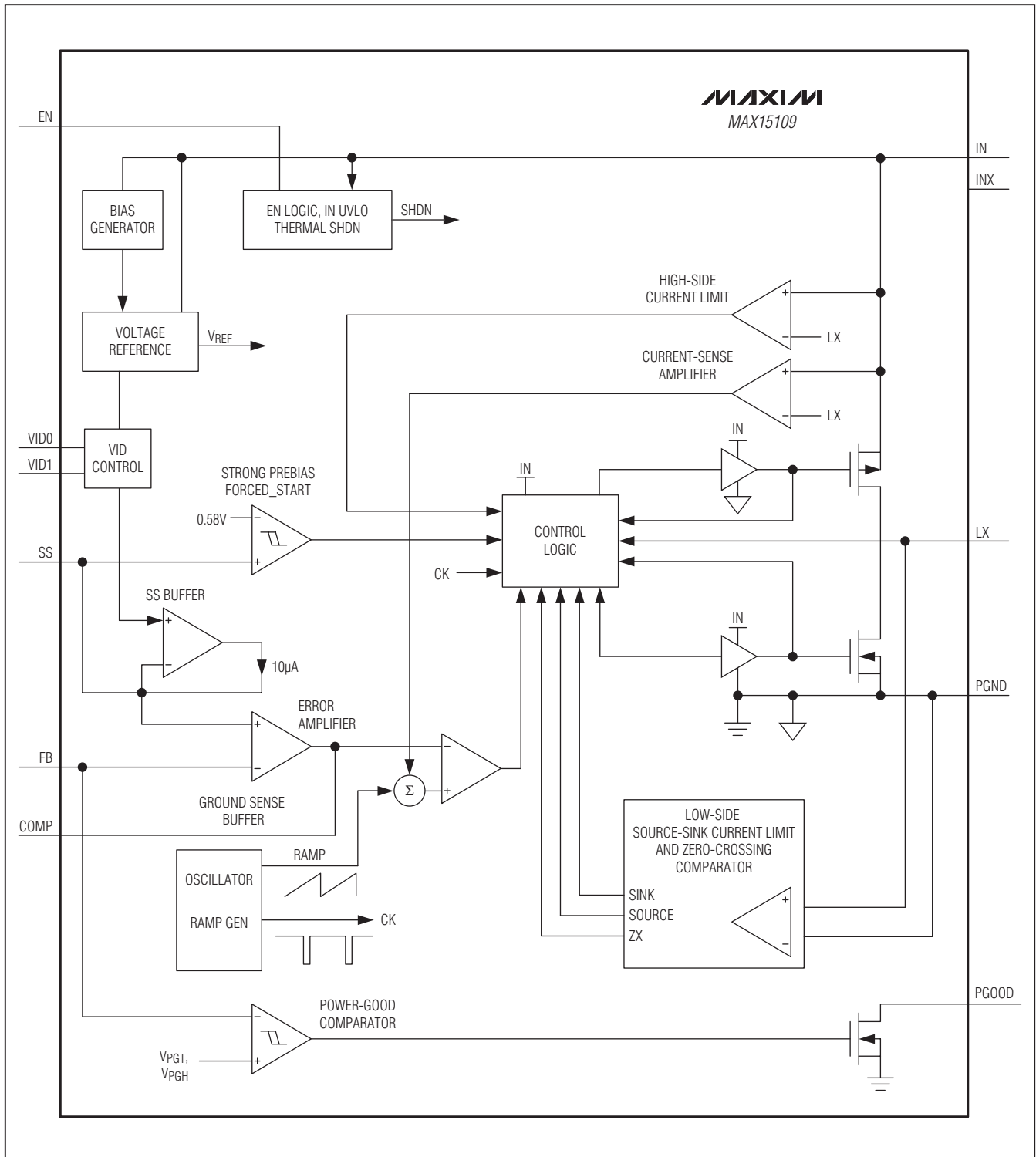

# High-Efficiency, 8A, Current-Mode Synchronous Step-Down Switching Regulator with VID Control

## Detailed Description

The MAX15109 high-efficiency, current-mode switching regulator delivers up to 8A of output current. The regulator operates from 2.7V to 5.5V and provides a VID selectable output.

The IC current-mode control architecture uses a high gain transconductance error amplifier that facilitates an easy compensation design and ensures cycle-by-cycle current limit with fast response to line and load transients.

The regulator features a 1MHz fixed switching frequency, allowing for all-ceramic capacitor designs with fast transient responses. The high operating frequency minimizes the size of external components. The IC is available in a 2.5mm x 2mm (4 x 5 array), 0.5mm pitch WLP package.

The regulator offers skip-mode functionality to reduce current consumption and achieve a high efficiency at light output loads. The low  $R_{DS(ON)}$  integrated switches ensure high efficiency at heavy loads while minimizing critical inductance, making the layout design a much simpler task than that of discrete solutions. The IC's simple layout and footprint assure first-pass success in new designs.

The IC has output voltages of 0.9V, 0.8V, 0.725V, and 0.625V by configuring the VID inputs. The regulator offers capacitor-programmable soft-start to reduce input inrush current. The device safely starts up into a prebiased output. The IC includes an enable input and open-drain PGOOD output for sequencing with other devices.

### Controller Function—PWM Logic

The controller logic block determines the duty cycle of the high-side MOSFET under different line, load, and temperature conditions. Under normal operation, where the current-limit and temperature protection are not triggered, the controller logic block takes the output from the PWM comparator to generate the driver signals for both high-side and low-side MOSFETs. The control logic block controls the break-before-make logic and all the necessary timing.

The high-side MOSFET turns on at the beginning of the oscillator cycle and turns off when the COMP voltage crosses the internal current-mode ramp waveform. The internal ramp is the sum of the compensation ramp and the current-mode ramp. The high-side MOSFET also turns off if the maximum duty cycle exceeds 95%, or when the current limit is reached. The low-side MOSFET turns on for the remainder of the switching cycle.

### Starting into a Prebiased Output

The IC can soft-start into a prebiased output without discharging the output capacitor. In safe prebiased startup, both low-side and high-side MOSFETs remain off to avoid discharging the prebiased output. PWM operation starts when the voltage on SS crosses the voltage on FB.

The IC can start into a prebiased voltage higher than the nominal set point without abruptly discharging the output. Forced PWM operation starts when the SS voltage reaches 0.58V, forcing the converter to start. When the low-side sink current-limit threshold of 14A is reached, the low-side switch turns off before the end of the clock period. The low-side sink current limit is 14A. The high-side switch turns on until one of the following conditions is satisfied:

- High-side source current hits the reduced high-side current limit (14A). The high-side switch turns off for the remaining time of clock period.
- The clock period ends.

Reduced high-side current limit is activated in order to recirculate the current into the high-side power switch rather than into the internal high-side body diode, which can cause damage to the devices. The high-side current limit is set to 14A.

Low-side sink current limit protects the low-side switch from excessive reverse current during prebiased operation.

### Enable Input

The IC features independent device enable control and power-good signal that allow for flexible power sequencing. Drive the enable input (EN) high to enable the regulator, or connect EN to IN for always-on operation. Power-good (PGOOD) is an open-drain output that goes high when  $V_{FB}$  is above the PGOOD threshold, and goes low if  $V_{FB}$  is below the PGOOD threshold.

# High-Efficiency, 8A, Current-Mode Synchronous Step-Down Switching Regulator with VID Control

## Programmable Soft-Start (SS)

The IC utilizes a soft-start feature to slowly ramp up the regulated output voltage to reduce input inrush current during startup. Connect a capacitor from SS to PGND to set the startup time. See the *Output Voltage Transition Timing* section for capacitor selection details.

## Error Amplifier

A high-gain error amplifier provides accuracy for the voltage feedback loop regulation. Connect a compensation network between COMP and SGND. See the *Compensation Design Guidelines* section. The error amplifier transconductance is 1.4mS. COMP clamp low is set to 0.8V, just below the PWM ramp compensation valley, helping COMP to rapidly return to the correct set point during load and line transients.

## PWM Comparator

The PWM comparator compares COMP voltage to the current-derived ramp waveform (LX current to COMP voltage transconductance value is 25A/V). To avoid instability due to subharmonic oscillations when the duty cycle is around 50% or higher, a compensation ramp is added to the current-derived ramp waveform. The compensation ramp slope ( $0.3V \times 1MHz = 0.3V/\mu s$ ) is equivalent to half of the inductor current down-slope in the worst case (load 2A, current ripple 30% and maximum duty-cycle operation of 95%). The compensation ramp valley is set to 1V.

## Overcurrent Protection and Hiccup

When the converter output is connected to ground or the device is overloaded, each high-side MOSFET current-limit event (14A) turns off the high-side MOSFET and turns on the low-side MOSFET. A 3-bit counter increments on each current-limit event. The counter is reset after three consecutive events of high-side MOSFET

turn-on without reaching the current limit. If the current-limit condition persists, the counter fills up reaching eight events. The control logic then discharges SS, stops both high-side and low-side MOSFETs and waits for a hiccup period (1024 clock cycles) before attempting a new soft-start sequence. The hiccup-mode also operates during soft-start.

## Thermal Shutdown Protection

The IC contains an internal thermal sensor that limits the total power dissipation to protect it in the event of an extended thermal fault condition. When the die temperature exceeds +160°C, the thermal sensor shuts down the device, turning off the DC-DC converter to allow the die to cool. After the die temperature falls by 25°C, the device restarts, following the soft-start sequence.

## Skip Mode Operation

The IC operates in skip mode. When in skip mode, LX output becomes high impedance when the inductor current falls below 0.7A. The inductor current does not become negative. During a clock cycle, if the inductor current falls below the 0.7A threshold (during off-time), the low side turns off. At the next clock cycle, if the output voltage is above the set point the PWM logic keeps both high-side and low-side MOSFETs off. If instead the output voltage is below the set point, the PWM logic drives the high-side on for a minimum fixed on-time (330ns). In this way, the system skips cycles, reducing the frequency of operations, and switches only as needed to service load at the cost of an increase in output-voltage ripple. See the *Skip Mode Frequency and Output Ripple* section for details. In skip mode, power dissipation is reduced and efficiency improved at light loads because the internal power MOSFETs do not switch at every clock cycle.

# High-Efficiency, 8A, Current-Mode Synchronous Step-Down Switching Regulator with VID Control

## Applications Information

### Setting the Output Voltage

The output voltage is selected by using the VID0 and VID1 control inputs. Table 1 summarizes the output voltages.

**Table 1. Output Voltages**

VID0	VID1	VOLTAGE (V)
0	0	0.9
0	1	0.8
1	0	0.725
1	1	0.675

### Inductor Selection

A large inductor value results in reduced inductor ripple current, leading to a reduced output ripple voltage. A high-value inductor is of a larger physical size with a higher series resistance (DCR) and a lower saturation current rating. Choose inductor values to produce a ripple current equal to 30% of the load current. Choose the inductor with the following formula:

$$L = \frac{V_{OUT}}{f_{SW} \times \Delta I_L} \times \left( 1 - \frac{V_{OUT}}{V_{IN}} \right)$$

where  $f_{SW}$  is the internally fixed 1MHz switching frequency, and  $\Delta I_L$  is the estimated inductor ripple current (typically set to  $0.3 \times I_{LOAD}$ ). In addition, the peak inductor current,  $I_{L\_PK}$ , must always be below the high-side current-limit value,  $I_{HSCL}$ , and the inductor saturation current rating,  $I_{L\_SAT}$ .

Ensure that the following relationship is satisfied:

$$I_{L\_PK} = I_{LOAD} + \frac{1}{2} \times \Delta I_L < \text{MIN}(I_{HSCL}, I_{L\_SAT})$$

### Input Capacitor Selection

For a step-down converter, the input capacitor  $C_{IN}$  helps to keep the DC input voltage steady, in spite of discontinuous input AC current. Use low-ESR capacitors to minimize the voltage ripple due to ESR.

Size  $C_{IN}$  using the following formula:

$$C_{IN} = \frac{I_{LOAD}}{f_{SW} \times \Delta V_{IN\_RIPPLE}} \times \frac{V_{OUT}}{V_{IN}}$$

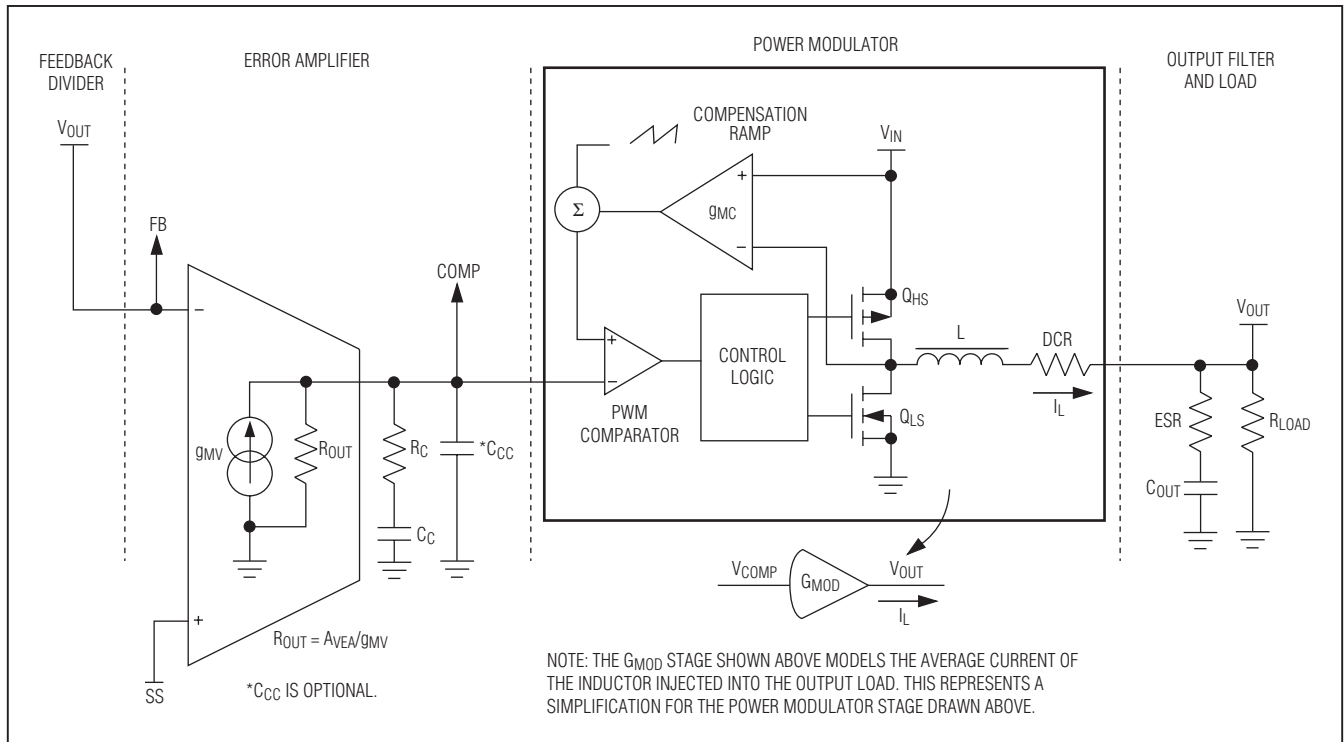

Figure 1. Peak Current-Mode Regulator Transfer Model

# High-Efficiency, 8A, Current-Mode Synchronous Step-Down Switching Regulator with VID Control

Make sure that the selected capacitance can accommodate the input ripple current given by:

$$I_{RMS} = I_O \times \frac{\sqrt{V_{OUT} \times (V_{IN} - V_{OUT})}}{V_{IN}}$$

If necessary, use multiple capacitors in parallel to meet the RMS current rating requirement.

## Output Capacitor Selection

Use low-ESR ceramic capacitors to minimize the voltage ripple due to ESR. Use the following formula to estimate the total output voltage peak-to-peak ripple:

$$\Delta V_{OUT} = \frac{V_{OUT}}{f_{SW} \times L} \times \left(1 - \frac{V_{OUT}}{V_{IN}}\right) \times \left(R_{ESR\_COUT} + \frac{1}{8 \times f_{SW} \times C_{OUT}}\right)$$

Select the output capacitors to produce an output ripple voltage that is less than 2% of the set output voltage.

## Output Voltage Transition Timing

The IC features programmable output voltage transition timing control. The regulator tracks the voltage on the SS pin that is set with a current-limited (10µA) VID DAC. A small capacitor at SS can therefore be used to set the transition timing for startup and VID transitions.

$$C_{SS} = \frac{I_{SS} \times \Delta t}{\Delta V_{OUT}}$$

where  $I_{SS}$  is the soft-start current of 10µA,  $\Delta V_{OUT}$  is the output-voltage transition, and  $\Delta t$  is the transition time. When using large  $C_{OUT}$  capacitance values, the high-side current limit can trigger during the soft-start period. To ensure the correct soft-start time,  $t_{SS}$ , choose  $C_{SS}$  large enough to satisfy:

$$C_{SS} \gg C_{OUT} = \frac{V_{OUT} \times I_{SS}}{(I_{HSCL\_MIN} - I_{LOAD}) \times V_{FB}}$$

$I_{HSCL\_MIN}$  is the minimum high-side switch current-limit value.

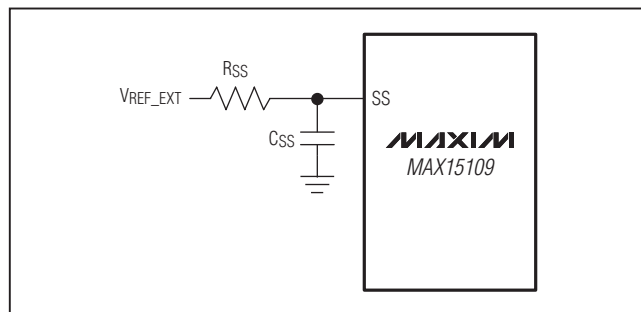

Figure 2. Setting Soft-Start Time

## Skip Mode Frequency and Output Ripple

In skip mode, the switching frequency ( $f_{SKIP}$ ) and output ripple voltage ( $V_{OUT-RIPPLE}$ ) shown in Figure 3 are calculated as follows:

$t_{ON}$  is a fixed time by design (330ns, typ); the peak inductor current reached is:

$$I_{SKIP-LIMIT} = \frac{V_{IN} - V_{OUT}}{2 \Delta V} t_{ON}$$

$t_{OFF1}$  is the time needed for the inductor current to reach the zero-crossing (~0A):

$$t_{OFF1} = \frac{L \times I_{SKIP-LIMIT}}{V_{OUT}}$$

During  $t_{ON}$  and  $t_{OFF1}$ , the output capacitor stores a charge equal to:

$$\Delta Q_{OUT} = \frac{L \times (I_{SKIP-LIMIT} - I_{LOAD})^2}{2} \times \left(\frac{1}{V_{IN} - V_{OUT}} + \frac{1}{V_{OUT}}\right)$$

During  $t_{OFF2}$  (=  $n \times t_{CK}$ , number of clock cycles skipped), the output capacitor loses this charge:

$$t_{OFF2} = \frac{\Delta Q_{OUT}}{I_{LOAD}} \rightarrow$$

$$t_{OFF2} = \frac{L \times (I_{SKIP-LIMIT} - I_{LOAD})^2}{2 \times I_{LOAD}} \times \left(\frac{1}{V_{IN} - V_{OUT}} + \frac{1}{V_{OUT}}\right)$$

Finally, frequency in skip mode is:

$$f_{SKIP} = \frac{1}{t_{ON} + t_{OFF1} + t_{OFF2}}$$

Output ripple in skip mode is:

$$V_{OUT-RIPPLE} = V_{COUT-RIPPLE} + V_{ESR-RIPPLE} = \frac{(I_{SKIP-LIMIT} - I_{LOAD}) \times t_{ON}}{C_{OUT}} + R_{ESR\_COUT} \times (I_{SKIP-LIMIT} - I_{LOAD})$$

$$V_{OUT-RIPPLE} = \left[ \frac{L \times I_{SKIP-LIMIT}}{C_{OUT} \times (V_{IN} - V_{OUT})} + R_{ESR\_COUT} \right] \times (I_{SKIP-LIMIT} - I_{LOAD})$$

Size  $C_{OUT}$  based on the above formula to limit output ripple in skip mode.

# High-Efficiency, 8A, Current-Mode Synchronous Step-Down Switching Regulator with VID Control

## Compensation Design Guidelines

The IC uses a fixed-frequency, peak-current-mode control scheme to provide easy compensation and fast transient response. The inductor peak current is monitored on a cycle-by-cycle basis and compared to the COMP voltage (output of the voltage error amplifier). The regulator's duty cycle is modulated based on the inductor's peak current value. This cycle-by-cycle control of the inductor current emulates a controlled current source. As a result, the inductor's pole frequency is shifted beyond the gain bandwidth of the regulator. System stability is provided with the addition of a simple series capacitor-resistor from COMP to PGND. This pole-zero combination serves to tailor the desired response of the closed-loop system. The basic regulator loop consists of a power modulator (comprising the regulator's pulse-width modulator, compensation ramp, control circuitry, MOSFETs, and inductor), the capacitive output filter and load, an output feedback, and a voltage-loop error amplifier with its associated compensation circuitry. See Figure 1.

The average current through the inductor is expressed as:

$$\bar{I}_L = G_{MOD} \times \bar{V}_{COMP}$$

where  $\bar{I}_L$  is the average inductor current and  $G_{MOD}$  is the power modulator's transconductance.

For a buck converter:

$$\bar{V}_{OUT} = R_{LOAD} \times \bar{I}_L$$

where  $R_{LOAD}$  is the equivalent load resistor value. Combining the above two relationships, the power modulator's transfer function in terms of  $\bar{V}_{OUT}$  with respect to  $\bar{V}_{COMP}$  is:

$$\frac{\bar{V}_{FB}}{\bar{V}_{COMP}} = \frac{R_{LOAD} \times \bar{I}_L}{\bar{I}_L} \times R_{LOAD} \times G_{MOD}$$

Having defined the power modulator's transfer function gain, the total system loop gain can be written as follows (see Figure 1):

$$\alpha = \frac{R_{OUT} \times (sC_C R_C + 1)}{[s(C_C + C_{CC})(R_C + R_{OUT}) + 1]} \times \frac{1}{[s(C_C \parallel C_{CC})(R_C \parallel R_{OUT}) + 1]}$$

$$\beta = G_{MOD} \times R_{LOAD} \times \frac{(sC_{OUT} ESR + 1)}{[sC_{OUT}(ESR + R_{LOAD}) + 1]}$$

$$\text{Gain} = \frac{R_2}{R_1 + R_2} \times \frac{A_{VEA}}{R_{OUT}} \times \alpha \times \beta$$

where  $R_{OUT}$  is the quotient of the error amplifier's DC gain,  $A_{VEA}$ , divided by the error amplifier's transconductance,  $g_{MV}$ ;  $R_{OUT}$  is much larger than  $R_C$ .

$$\frac{R_2}{R_1 + R_2} = \frac{V_{FB}}{V_{OUT}}$$

Also,  $C_C$  is much larger than  $C_{CC}$ , therefore:

$$C_C + C_{CC} \approx C_C$$

and

$$C_C \parallel C_{CC} \approx C_{CC}$$

Rewriting:

$$\text{Gain} = \frac{V_{FB}}{V_{OUT}} \times A_{VEA} \times \frac{(sC_C R_C + 1)}{[sC_C \left(\frac{A_{VEA}}{g_{MV}}\right) + 1] \times (sC_{CC} R_C + 1)} \times G_{MOD} \times R_{LOAD} \times \frac{(sC_{OUT} ESR + 1)}{[sC_{OUT}(ESR + R_{LOAD}) + 1]}$$

The dominant poles and zeros of the transfer loop gain are shown below:

$$f_{P1} = \frac{g_{MV}}{2\pi \times 10^{AVEA\_dB/20} \times C_C}$$

$$f_{P2} = \frac{1}{2\pi \times C_{OUT}(ESR + R_{LOAD})}$$

$$f_{P3} = \frac{1}{2\pi \times C_{CC} R_C}$$

$$f_{Z1} = \frac{1}{2\pi \times C_C R_C}$$

$$f_{Z2} = \frac{1}{2\pi \times C_{OUT} ESR}$$

# High-Efficiency, 8A, Current-Mode Synchronous Step-Down Switching Regulator with VID Control

The order of pole-zero occurrence is:

$$f_{P1} < f_{P2} < f_{Z1} < f_{Z2} \leq f_{P3}$$

Under heavy load,  $f_{P2}$ , approaches  $f_{Z1}$ . A graphical representation of the asymptotic system closed-loop response, including dominant pole and zero locations is shown in Figure 3.

If  $C_{OUT}$  is large, or exhibits a lossy equivalent series resistance (large ESR), the circuit's second zero might come into play around the crossover frequency ( $f_{CO} = \omega/2\pi$ ). In this case, a third pole can be induced by a second (optional) small compensation capacitor ( $C_{CC}$ ), connected from COMP to PGND. The loop response's fourth asymptote (in bold, Figure 4) is the one of interest in establishing the desired crossover frequency (and determining the compensation component values). A lower crossover frequency provides for stable closed-loop operation at the expense of a slower load and line transient response. Increasing the crossover frequency improves the transient response at the (potential) cost of system instability. A standard rule of thumb sets the crossover frequency  $\leq 1/10$ th of the switching frequency. First, select the passive and active power components that meet the application's requirements. Then, choose the small-signal compensation components to achieve the desired closed-loop frequency response and phase margin as outlined in the *Closing the Loop: Designing the Compensation Circuitry* section.

## Closing the Loop: Designing the Compensation Circuitry

Select the desired crossover frequency. Choose  $f_{CO}$  approximately 1/10th of the switching frequency  $f_{SW}$ , or  $f_{CO} \approx 100\text{kHz}$ .

Select  $R_C$  using the transfer-loop's fourth asymptote gain (assuming  $f_{CO} > f_{P1}$ ,  $f_{P2}$ , and  $f_{Z1}$  and setting the overall loop gain to unity) as follows:

$$1 = \frac{V_{FB}}{V_{OUT}} \times g_{MV} \times R_C \times G_{MOD} \times R_{LOAD} \times \frac{1}{2\pi \times f_{CO} \times C_{OUT} \times (ESR + R_{LOAD})}$$

therefore:

$$R_C = \frac{V_{OUT}}{V_{FB}} \times \frac{2\pi \times f_{CO} \times C_{OUT} \times (ESR + R_{LOAD})}{g_{MV} \times G_{MOD} \times R_{LOAD}}$$

For  $R_{LOAD}$  much greater than ESR, the equation can be further simplified as follows:

$$R_C = \frac{V_{OUT}}{V_{FB}} \times \frac{2\pi \times f_{CO} \times C_{OUT}}{g_{MV} \times G_{MOD}}$$

where  $V_{FB}$  is equal to 0.6V.

Determine  $C_C$  by selecting the desired first system zero,  $f_{Z1}$ , based on the desired phase margin. Typically, setting  $f_{Z1}$  below 1/5th of  $f_{CO}$  provides sufficient phase margin.

$$f_{Z1} \leq \frac{1}{2\pi \times C_C R_C} \times \frac{f_{CO}}{5}$$

Therefore:

$$C_C \geq \frac{5}{2\pi \times f_{CO} \times R_C}$$

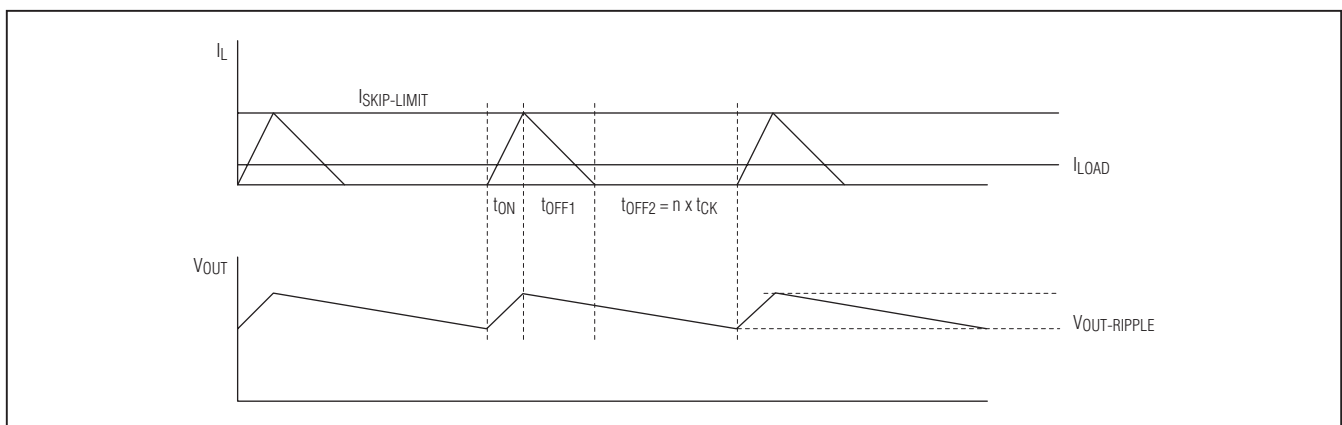

Figure 3. Skip-Mode Waveforms

# High-Efficiency, 8A, Current-Mode Synchronous Step-Down Switching Regulator with VID Control

If the ESR output zero is located at less than one-half the switching frequency, use the (optional) secondary compensation capacitor,  $C_{CC}$ , to cancel it, as follows:

$$\frac{1}{2\pi \times C_{CC} R_C} = f_{P3} = f_{Z2} = \frac{1}{2\pi \times C_{OUT} ESR}$$

therefore:

$$C_{CC} = \frac{C_{OUT} \times ESR}{R_C}$$

If the ESR zero exceeds 1/2 the switching frequency, use the following equation:

$$f_{P3} = \frac{1}{2\pi \times C_{CC} R_C} = \frac{f_{SW}}{2}$$

therefore:

$$C_{CC} = \frac{2}{2\pi \times f_{SW} \times R_C}$$

Overall  $C_{CC}$  detracts from the overall system phase margin. Place this third pole well beyond the desired crossover frequency to minimize the interaction with the system loop response at crossover. Ignore  $C_{CC}$  in these calculations if  $C_{CC}$  is smaller than 10pF.

### Power Dissipation

The IC is available in a 20-bump WLP package and can dissipate up to 1.27W at +70°C board temperature. When the die temperature exceeds +155°C, the thermal-shutdown protection is activated. See the *Thermal Shutdown Protection* section.

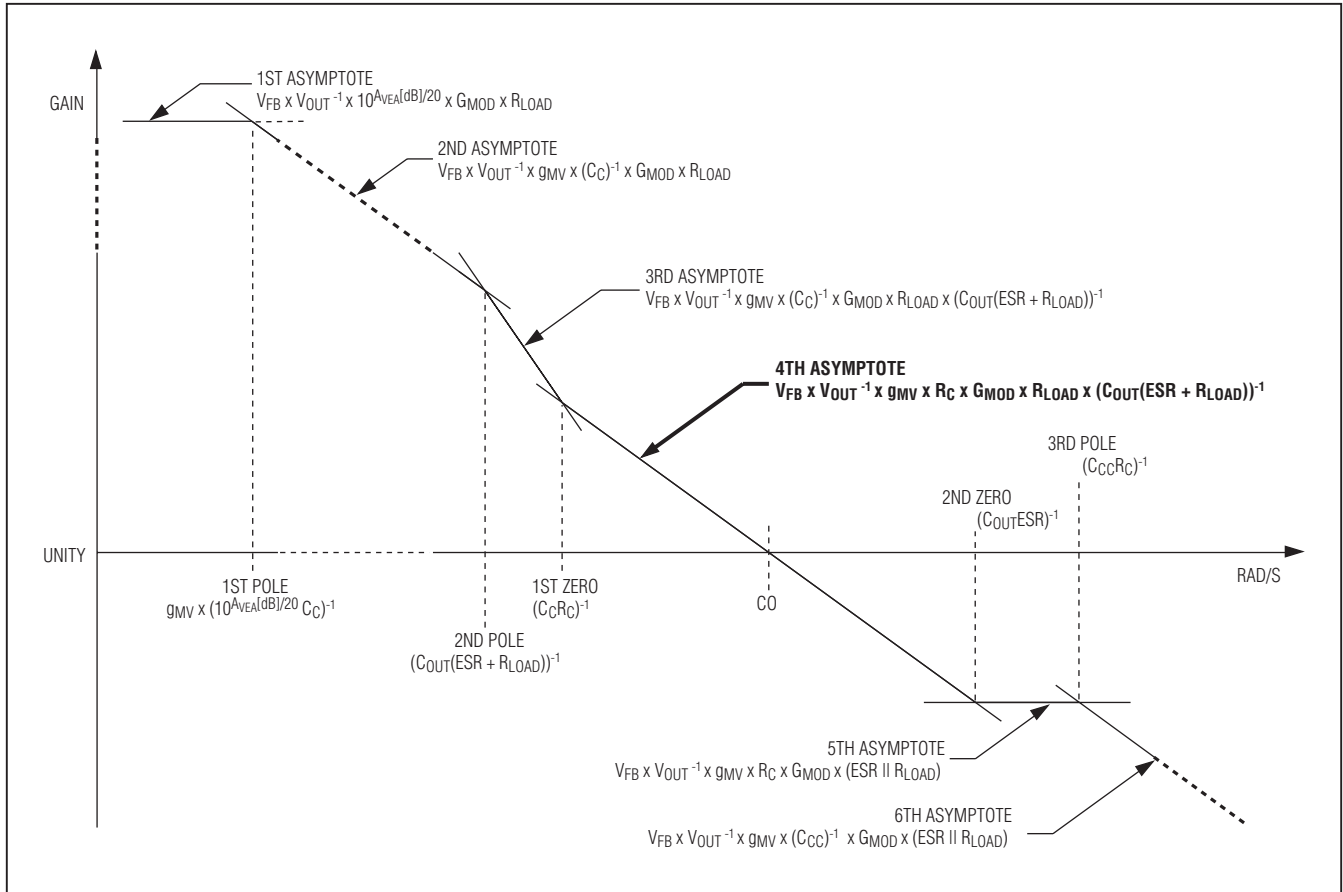

Figure 4. Asymptotic Loop Response of Peak Current-Mode Regulator



# High-Efficiency, 8A, Current-Mode Synchronous Step-Down Switching Regulator with VID Control

## Layout Procedure

Careful PCB layout is critical to achieve clean and stable operation. It is highly recommended to duplicate the MAX15109 evaluation kit layout for optimum performance. If deviation is necessary, follow these guidelines for good PCB layout:

- 1) Connect input and output capacitors to the power ground plane.
- 2) Place bypass capacitors as close to IN and the soft-start capacitor as close to SS as possible.
- 3) Keep the high-current paths as short and wide as possible. Keep the path of switching current short and minimize the loop area formed by LX, the output capacitors, and the input capacitors.
- 4) Connect IN, LX, and PGND separately to a large copper area to help cool the IC to further improve efficiency.
- 5) Ensure all feedback connections are short and direct. Place the feedback resistors and compensation components as close as possible to the IC.
- 6) Route high-speed switching nodes (such as LX) away from sensitive analog areas (such as FB, COMP, SGND, and SS).

## Typical Application Circuit

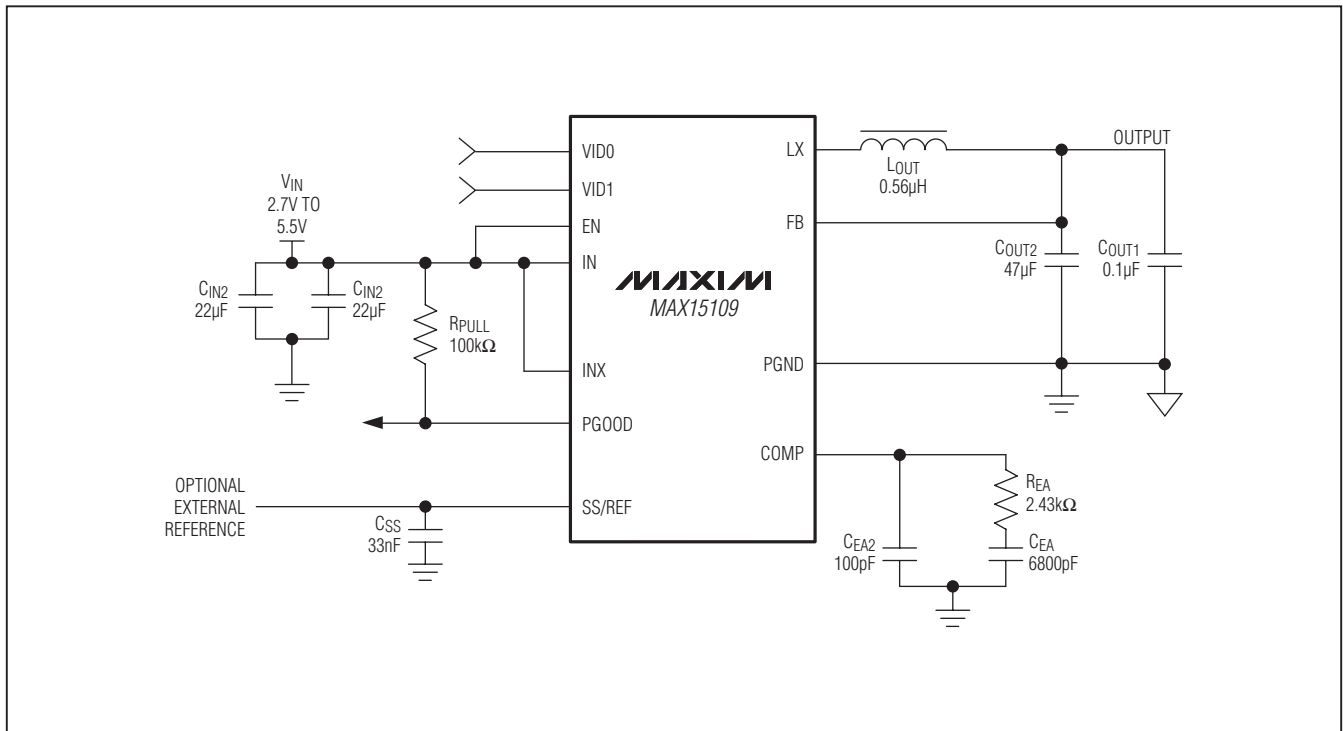

# High-Efficiency, 8A, Current-Mode Synchronous Step-Down Switching Regulator with VID Control

## Chip Information

PROCESS: BiCMOS

## Package Information

For the latest package outline information and land patterns (footprints), go to [www.maxim-ic.com/packages](http://www.maxim-ic.com/packages). Note that a "+", "#", or "-" in the package code indicates RoHS status only. Package drawings may show a different suffix character, but the drawing pertains to the package regardless of RoHS status.

PACKAGE TYPE	PACKAGE CODE	OUTLINE NO.	LAND PATTERN NO.
20 WLP	W202D2Z+1	<a href="#">21-0505</a>	Refer to <a href="#">Application Note 1891</a>

# High-Efficiency, 8A, Current-Mode Synchronous Step-Down Switching Regulators with VID Control

## Revision History

REVISION NUMBER	REVISION DATE	DESCRIPTION	PAGES CHANGED
0	6/11	Initial release	—
1	8/11	Updated <i>Package Thermal Characteristics, Electrical Characteristics, Bump Description, and Typical Application Circuit</i>	2, 3, 8, 16, 17

MAX15109

Maxim cannot assume responsibility for use of any circuitry other than circuitry entirely embodied in a Maxim product. No circuit patent licenses are implied. Maxim reserves the right to change the circuitry and specifications without notice at any time.

Maxim Integrated Products, 120 San Gabriel Drive, Sunnyvale, CA 94086 408-737-7600 \_\_\_\_\_ 19