



Technical Data Sheet

3mm Infrared LED , T-1

IR204C/H16/L10

Features

- High reliability
- Good spectral matching to Si photodetector
- Peak wavelength $\lambda_p=940\text{nm}$
- 2.54mm Lead spacing
- Low forward voltage
- Pb free
- This product itself will remain within RoHS compliant version.



Descriptions

- EVERLIGHT's Infrared Emitting Diode (IR204C/H16/L10) is a high intensity diode , molded in a water clear plastic package.
- The device is spectrally matched with phototransistor , photodiode and infrared receiver module.

Applications

- Free air transmission system
- Infrared remote control units with high power requirement
- Smoke detector
- Infrared applied system

Device Selection Guide

LED Part No.	Chip	Lens Color
	Material	
IR204C/H6/L10	GaAlAs	Water clear

Package Dimensions

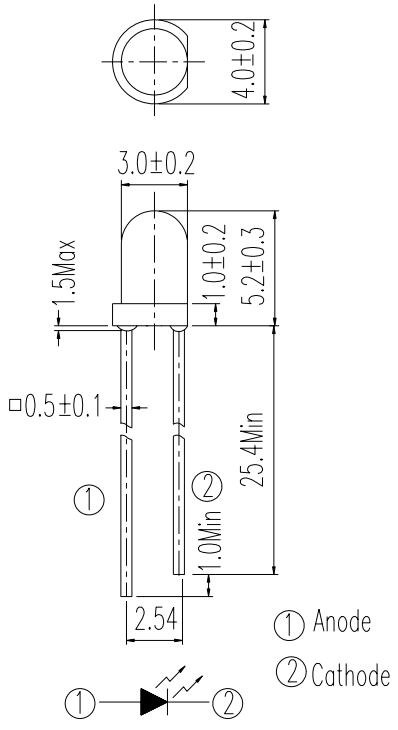

- Notes:** 1.All dimensions are in millimeters
 2.Tolerances unless dimensions $\pm 0.25\text{mm}$

Absolute Maximum Ratings (Ta=25°C)

Parameter	Symbol	Rating	Units
Continuous Forward Current	I_F	50	mA
Peak Forward Current	I_{FP}	1.0	A
Reverse Voltage	V_R	5	V
Operating Temperature	T_{opr}	-40 ~ +85	°C
Storage Temperature	T_{stg}	-40 ~ +85	°C
Soldering Temperature	T_{sol}	260	°C
Power Dissipation at(or below) 25°C Free Air Temperature	P_d	150	mW

- Notes:** *1: I_{FP} Conditions--Pulse Width $\leq 100 \mu s$ and Duty $\leq 1\%$.
 *2:Soldering time ≤ 5 seconds.

Electro-Optical Characteristics (Ta=25°C)

Parameter	Symbol	Condition	Min.	Typ.	Max.	Units
Radiant Intensity	Ee	I _F =20mA	2.8	5	--	mW/sr
		I _F =100mA Pulse Width ≤ 100 μs ,Duty ≤ 1%	--	35	--	
		I _F =1A Pulse Width ≤ 100 μs ,Duty ≤ 1%.	--	350	--	
Peak Wavelength	λ _p	I _F =20mA	--	940	--	nm
Spectral Bandwidth	Δλ	I _F =20mA	--	45	--	nm
Forward Voltage	V _F	I _F =20mA		1.2	1.5	V
		I _F =100mA Pulse Width ≤ 100 μs ,Duty ≤ 1%	--	1.4	1.8	
		I _F =1A Pulse Width ≤ 100 μs ,Duty ≤ 1%.	--	2.6	4.0	
Reverse Current	I _R	V _R =5V	--	--	10	μA
View Angle	2θ 1/2	I _F =20mA	--	50	--	deg

Rank

 Condition : I_F=20mA

Unit : mW/sr

Bin Number	J	K	L
Min	2.8	4.0	5.6
Max	4.5	6.4	8.9

Typical Electro-Optical Characteristics Curves

Fig.1 Forward Current vs. Ambient Temperature

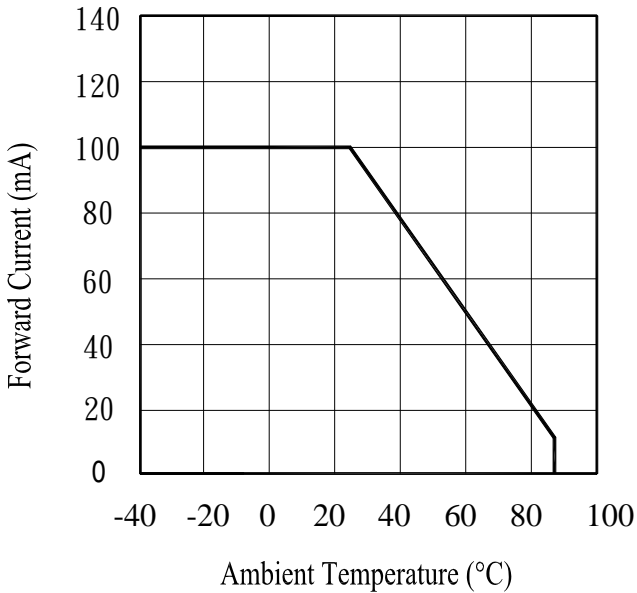

Fig.2 Spectral Distribution

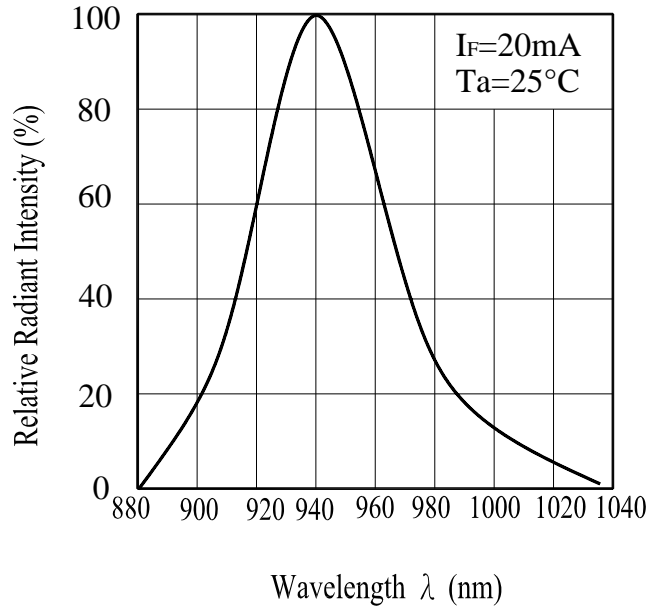

Fig.3 Peak Emission Wavelength vs. Ambient Temperature

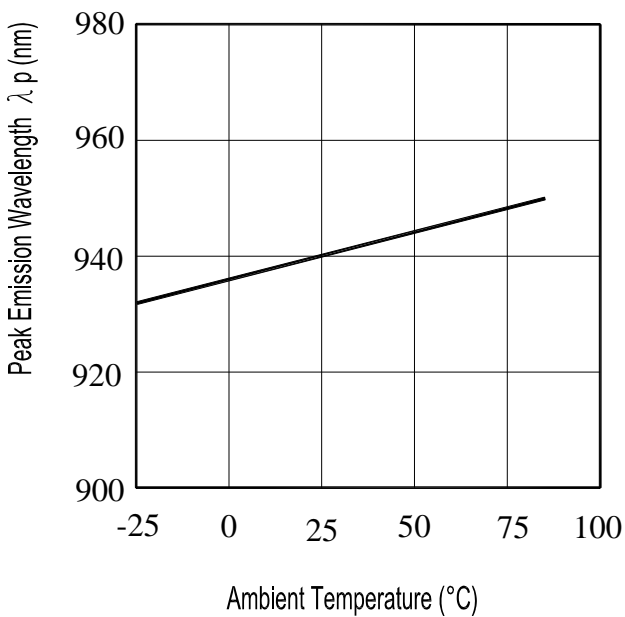
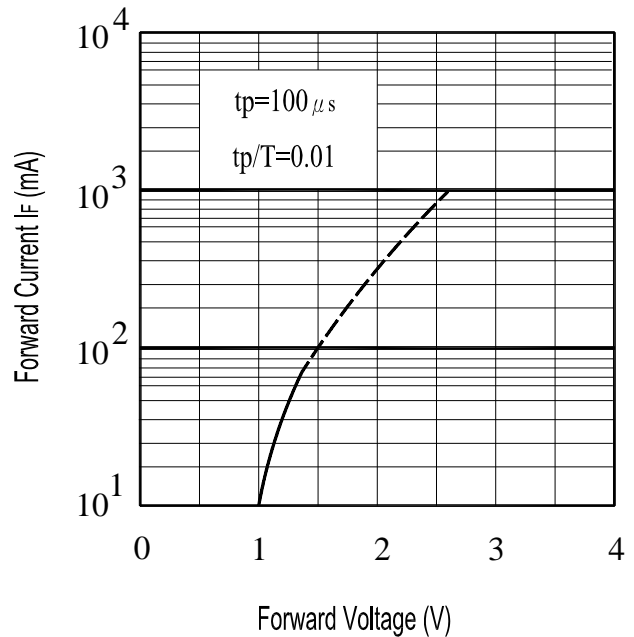

Fig.4 Forward Current vs. Forward Voltage



Typical Electro-Optical Characteristics Curves

Fig.5 Relative Intensity vs.

Forward Current

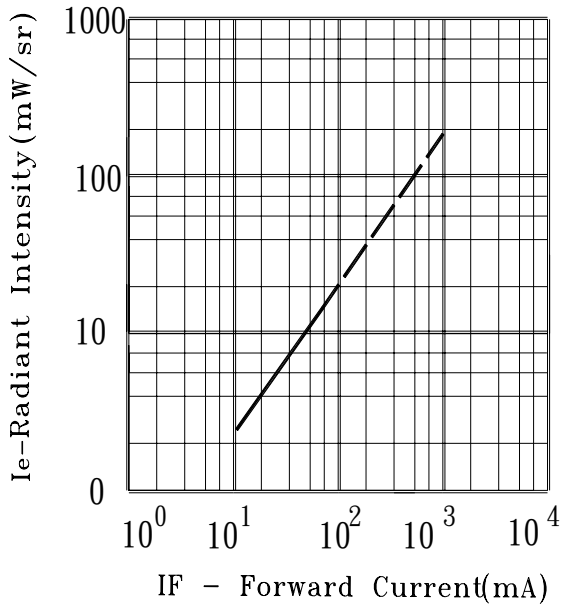

Fig.6 Relative Radiant Intensity vs.

Angular Displacement

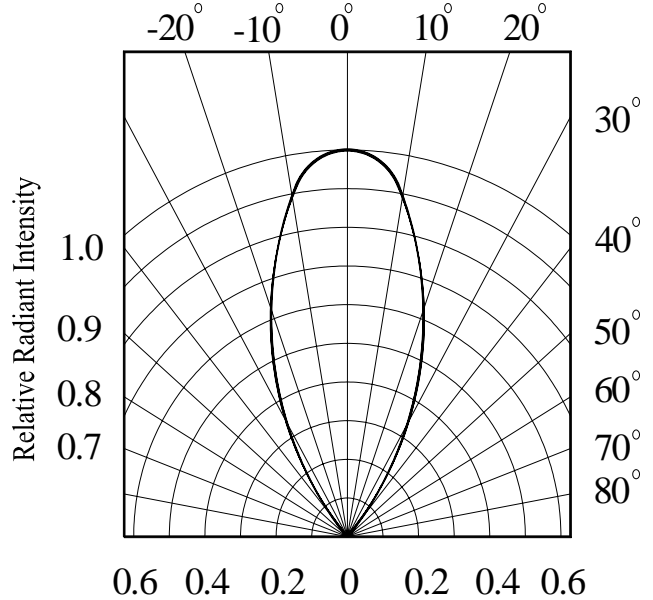

Fig.7 Relative Intensity vs.

Ambient Temperature(°C)

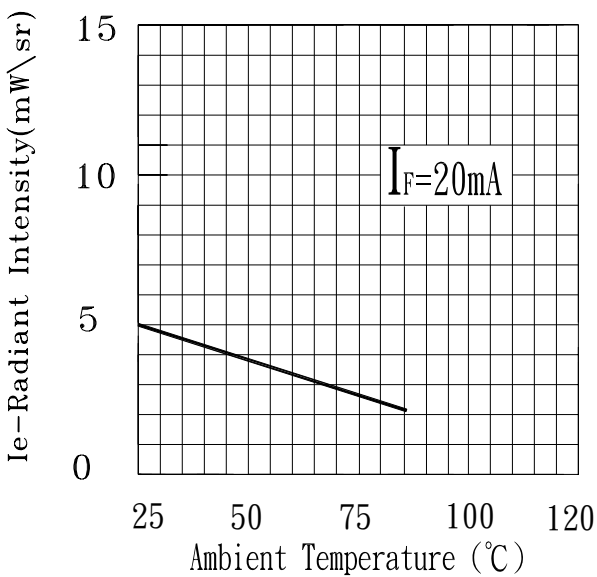
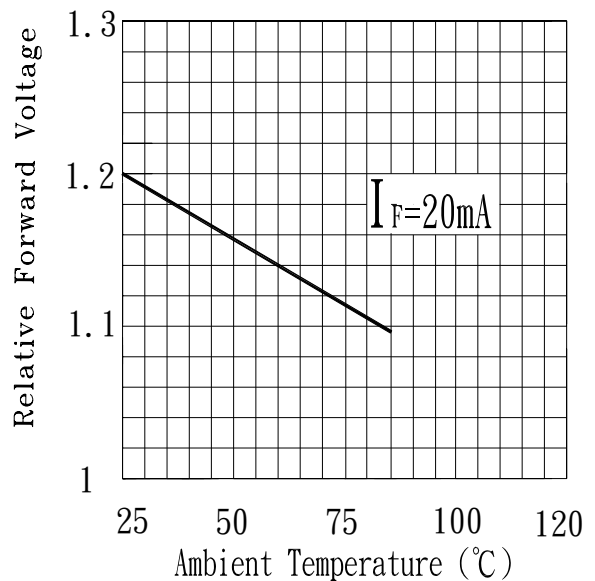

Fig.8 Forward Current vs.

Ambient Temperature(°C)





Reliability Test Item And Condition

The reliability of products shall be satisfied with items listed below.

Confidence level : 90%

LTPD : 10%

NO.	Item	Test Conditions	Test Hours/ Cycles	Sample Sizes	Failure Judgement Criteria	Ac/Re
1	Solder Heat	TEMP. : 260°C±5°C	10secs	22pcs	Vf ≥ U or Vf ≤ L	0/1
2	Temperature Cycle	H : +100°C 15mins <div style="text-align: center;">  </div> 5mins L : -40°C 15mins	300Cycles	22pcs	Power brightness attenuate difference>20%	0/1
3	Thermal Shock	H :+100°C 5mins <div style="text-align: center;">  </div> 10secs L :-10°C 5mins	300Cycles	22pcs	U : Upper Specification	0/1
4	High Temperature Storage	TEMP. : +100°C	1000hrs	22pcs	Limit L : Lower	0/1
5	Low Temperature Storage	TEMP. : -40°C	1000hrs	22pcs	Specification Limit	0/1
6	DC Operating Life	I _F =20mA	1000hrs	22pcs		0/1
7	High Temperature/ High Humidity	85°C / 85% R.H	1000hrs	22pcs		0/1



IR204C/H16/L10

Packing Quantity Specification

1. 1000PCS/1Bag,4Bag/1Box
2. 10Boxes/1Carton

Label Form Specification

		CPN: Customer's Production Number
CPN:		P/N : Production Number
P/N:		QTY: Packing Quantity
		CAT: Ranks
	IR204C/H16/L10	HUE: Peak Wavelength
QTY:		REF: Reference
		LOT No: Lot Number
LOT NO:		

Notes

1. Above specification may be changed without notice. EVERLIGHT will reserve authority on material change for above specification.
2. When using this product, please observe the absolute maximum ratings and the instructions for using outlined in these specification sheets. EVERLIGHT assumes no responsibility for any damage resulting from use of the product which does not comply with the absolute maximum ratings and the instructions included in these specification sheets.
3. These specification sheets include materials protected under copyright of EVERLIGHT corporation. Please don't reproduce or cause anyone to reproduce them without EVERLIGHT's consent.

EVERLIGHT ELECTRONICS CO., LTD.
Office: No 25, Lane 76, Sec 3, Chung Yang Rd,
Tucheng, Taipei 236, Taiwan, R.O.C

Tel: 886-2-2267-2000, 2267-9936
Fax: 886-2267-6244, 2267-6189, 2267-6306
<http://www.everlight.com>