



Technical Data Sheet

1.9mm Round Subminiature“ Z-Bend” Lead Phototransistor

PT91-21C/TR10

Features

- Fast response time
- High photo sensitivity
- Small junction capacitance
- Compatible with infrared and vapor phase reflow solder process.
- Pb free
- The product itself will remain within RoHS compliant versio

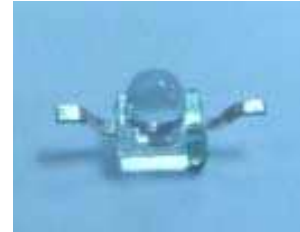

Descriptions

- PT91-21C/TR10 is a phototransistor in miniature SMD package which is molded in water clear plastic with spherical top view lens. The device is spectrally matched to infrared emitting diode.

Applications

- Miniature switch
- Counters and sorter
- Position sensor
- Infrared applied system

Device Selection Guide

LED Part No.	Chip	Lens Color
	Material	
PT	Silicon	Water clear

Electro-Optical Characteristics (Ta=25°C)

Parameter	Symbol	Condition	Min	Typ	Max	Unit
Rang Of Spectral Bandwidth	$10\% \lambda_p$	---	400	---	1100	nm
Wavelength Of Peak Sensitivity	λ_p	---	---	940	---	nm
Collector-Emitter Breakdown Voltage	BV_{CEO}	$I_C=100 \mu A$ $E_e=0mW/cm^2$	30	---	---	V
Emitter-Collector Breakdown Voltage	BV_{ECO}	$I_E=100 \mu A$ $E_e=0mW/cm^2$	5	---	---	V
Collector-Emitter Saturation Voltage	$V_{CE(sat)}$	$I_C=2mA$ $E_e=1m W/cm^2$	---	---	0.4	V
Collector Dark Current	I_{CEO}	$V_{CE}=20V$ $E_e=0mW/cm^2$	---	---	100	nA
On State Collector Current	$I_{C(ON)}$	$V_{CE}=5V$ $E_e=1mW /cm^2$	1.0	1.5	---	mA
Rise Time	t_r	$V_{CE}=5V$ $I_C=1mA$ $R_L=1000 \Omega$	---	15	---	μS
Fall Time	t_f		---	15	---	

Intensity Specifications for Bin Grading

Rank	Test Condition	Min	Max	Unit
Bin1	$E_e=1mW/cm^2$ $V_{CE}=5V$	1.0	2.0	mA
Bin2		1.5	3.0	
Bin3		2.0	4.0	
Bin4		2.5	5.0	
Bin5		3.0	6.0	

Typical Electro-Optical Characteristics Curves

Fig.1 Collector Power Dissipation vs. Ambient Temperature

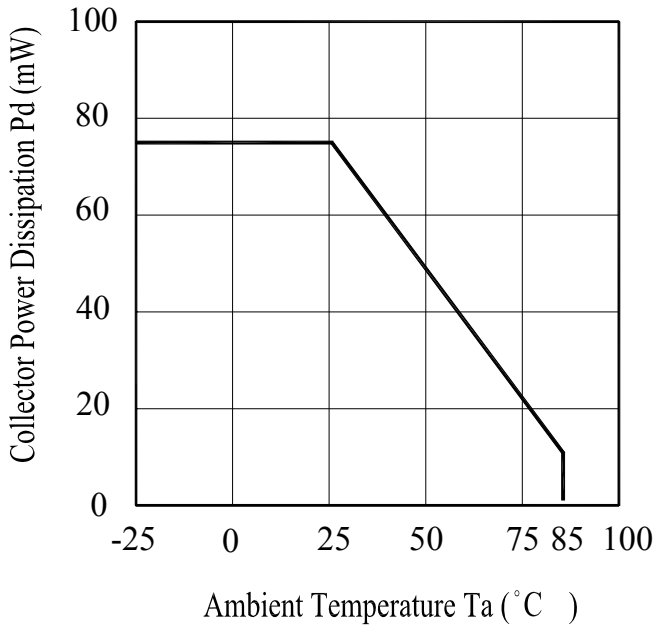

Fig.2 Spectral Sensitivity

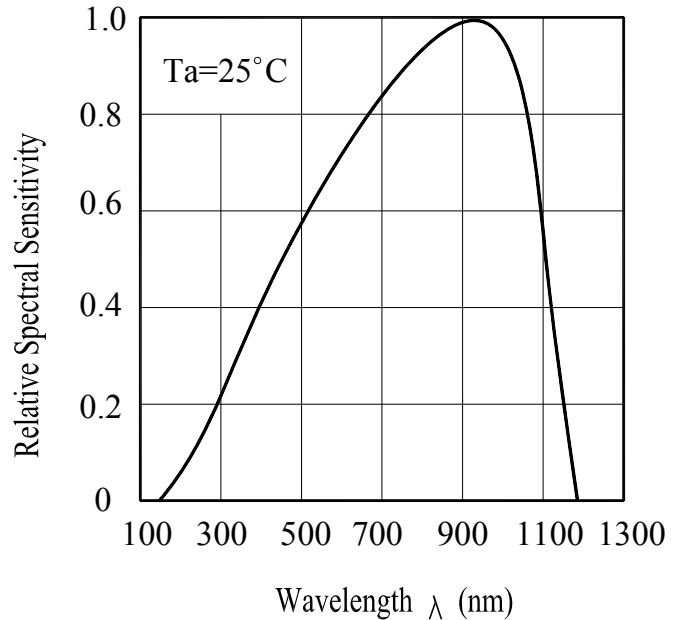

Fig.3 Relative Collector Current vs. Ambient Temperature

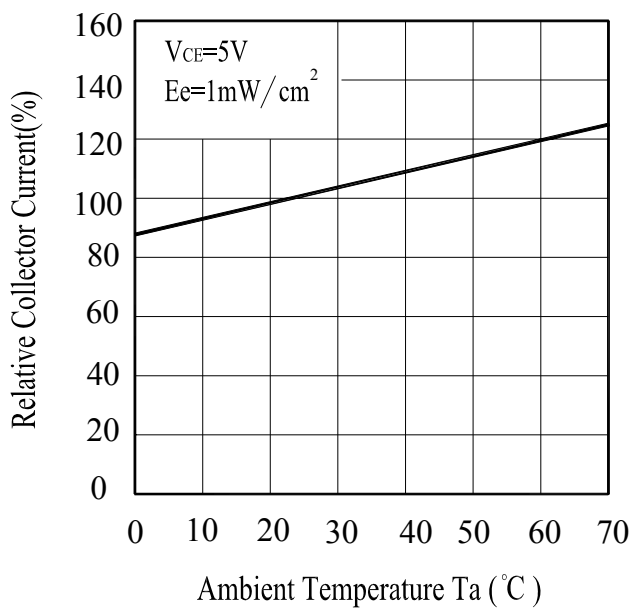
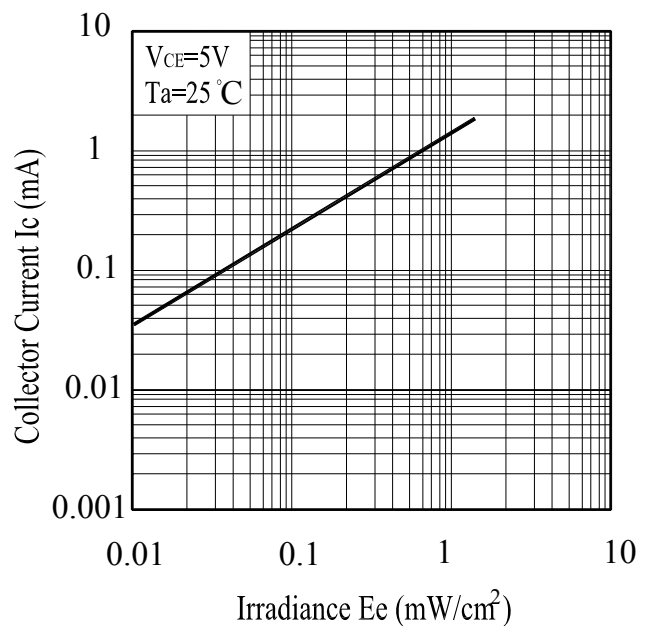

Fig.4 Collector Current vs. Irradiance



Typical Electro-Optical Characteristics Curves

Fig.5 Collector Dark Current vs. Ambient Temperature

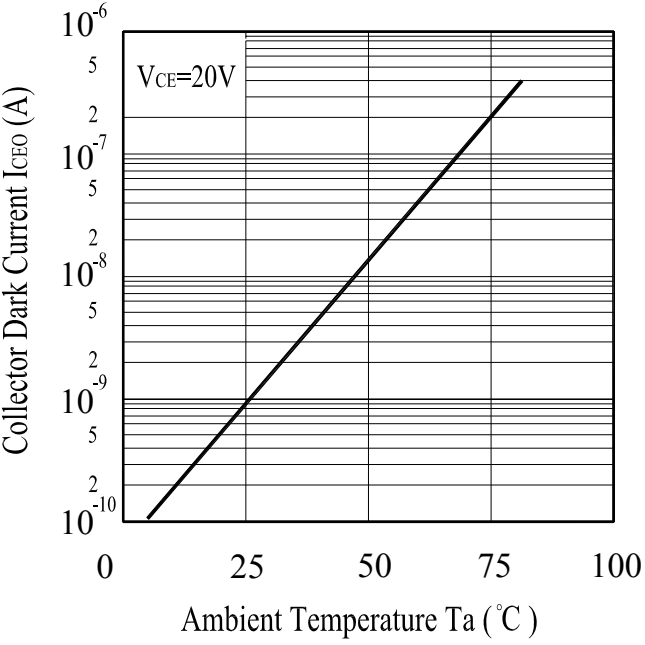
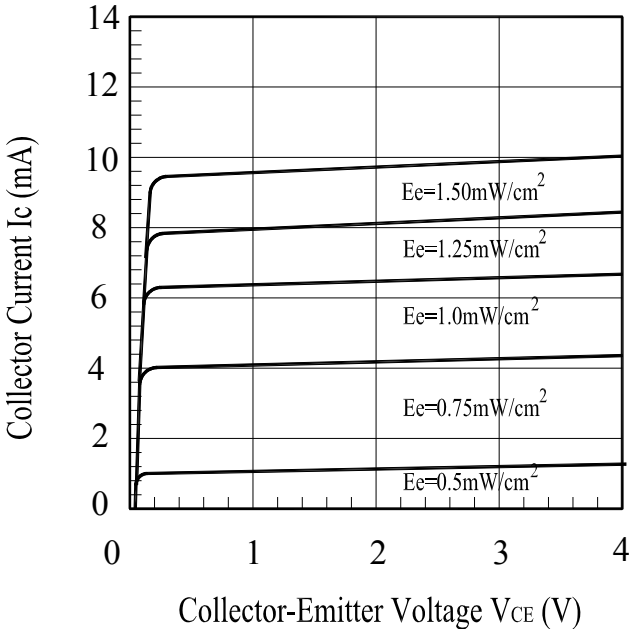

Fig.6 Collector Current vs. Collector-Emitter Voltage



Precautions For Use

1. Over-current-proof

Customer must apply resistors for protection , otherwise slight voltage shift will cause big current change (Burn out will happen).

2. Storage

2.1 Do not open moisture proof bag before the products are ready to use.

2.2 Before opening the package, the LEDs should be kept at 30°C or less and 90%RH or less.

2.3 The LEDs should be used within a year.

2.4 After opening the package, the LEDs should be kept at 30°C or less and 70%RH or less.

2.5 The LEDs should be used within 168 hours (7 days) after opening the package.

2.6 If the moisture absorbent material (silica gel) has faded away or the LEDs have exceeded the storage time, baking treatment should be performed using the following conditions.

Baking treatment : $60\pm 5^{\circ}\text{C}$ for 24 hours.

3. Soldering Condition

3.1 Pb-free solder temperature profile

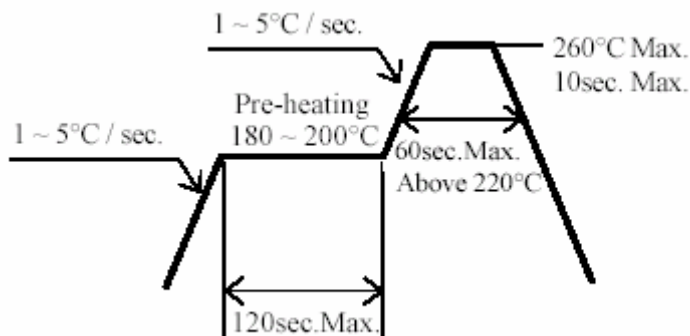

3.2 Reflow soldering should not be done more than two times.

3.3 When soldering, do not put stress on the LEDs during heating.

3.4 After soldering, do not warp the circuit board.

4.Soldering Iron

Each terminal is to go to the tip of soldering iron temperature less than 280°C for 3 seconds within once in less than the soldering iron capacity 25W. Leave two seconds and more intervals, and do soldering of each terminal. Be careful because the damage of the product is often started at the time of the hand solder.

5.Repairing

Repair should not be done after the LEDs have been soldered. When repairing is unavoidable, a double-head soldering iron should be used (as below figure). It should be confirmed beforehand whether the characteristics of the LEDs will or will not be damaged by repairing.

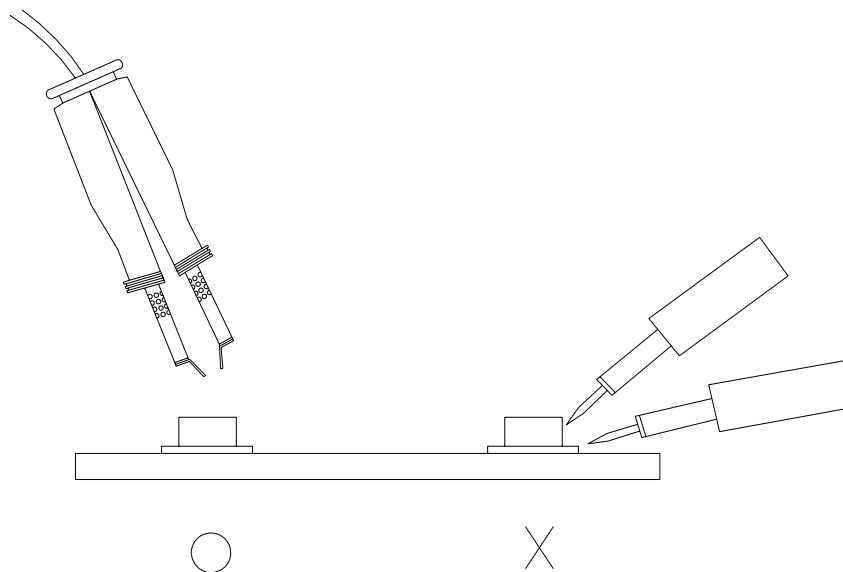

Reliability Test Item And Condition

The reliability of products shall be satisfied with items listed below.

Confidence level : 90%

LTPD : 10%

NO.	Item	Test Conditions	Test Hours/ Cycles	Sample Sizes	Failure Judgement Criteria	Ac/Re
1	REFLOW	TEMP. : 260°C±5°C 5secs	6Mins	22pcs		0/1
2	Temperature Cycle	H : 100°C 15mins ↕ 5mins L : -40°C 15mins	50Cycles	22pcs	$I_L \leq L \times 0.8$ L : Lower	0/1
3	Thermal Shock	H : +100°C 5mins ↕ 10secs L : -10°C 5mins	50Cycles	22pcs	Specification Limit	0/1
4	High Temperature Storage	TEMP. : +100°C	1000hrs	22pcs		0/1
5	Low Temperature Storage	TEMP. : -40°C	1000hrs	22pcs		0/1
6	DC Operating Life	$V_{CE}=5V$	1000hrs	22pcs		0/1
7	High Temperature/ High Humidity	85°C / 85% R.H	1000hrs	22pcs		0/1



PT91-21C/TR10

Packing Quantity Specification

- 1.1000Pcs/1Volume · 1Volume/1Bag
- 2.10Boxes/1Carton

Label Form Specification

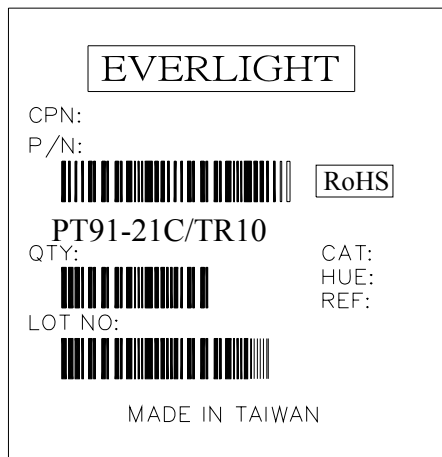

CPN: Customer's Production Number
P/N : Production Number
QTY: Packing Quantity
CAT: Ranks
HUE: Peak Wavelength
REF: Reference
LOT No: Lot Number
MADE IN TAIWAN: Production Place

Notes

1. Above specification may be changed without notice. EVERLIGHT will reserve authority on material change for above specification.
2. When using this product, please observe the absolute maximum ratings and the instructions for using outlined in these specification sheets. EVERLIGHT assumes no responsibility for any damage resulting from use of the product which does not comply with the absolute maximum ratings and the instructions included in these specification sheets.
3. These specification sheets include materials protected under copyright of EVERLIGHT corporation. Please don't reproduce or cause anyone to reproduce them without EVERLIGHT's consent.

EVERLIGHT ELECTRONICS CO., LTD.
Office: No 25, Lane 76, Sec 3, Chung Yang Rd,
Tucheng, Taipei 236, Taiwan, R.O.C

Tel: 886-2-2267-2000, 2267-9936
Fax: 886-2267-6244, 2267-6189, 2267-6306
<http://www.everlight.com>