

4 PIN DIP PHOTOTRANSISTOR PHOTOCOUPLER

EL815 Series

Features:

- Current transfer ratio
(CTR: 600~7500% at $I_F = 1\text{mA}$, $V_{CE} = 2\text{V}$)
- High isolation voltage between input and output ($V_{iso} = 5000\text{ V rms}$)
- Creepage distance $> 7.62\text{ mm}$
- Operating temperature up to $+110^\circ\text{C}$
 - Compact small outline package
 - Pb free and RoHS compliant.
 - UL approved (No. E214129)
 - VDE approved (No. 132249)
 - CSA approved (No. 1143601)
 - SEMKO approved
 - NEMKO approved
 - DEMKO approved
 - FIMKO approved
 - CQC approved

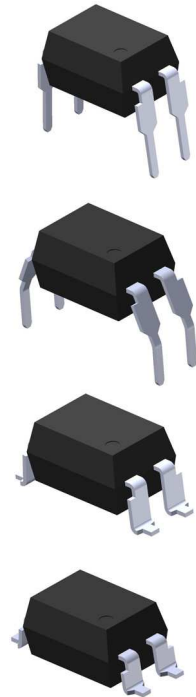

Description

The EL815 series of devices each consist of an infrared emitting diodes, optically coupled to a photo Darlington detector.

They are packaged in a 4-pin DIP package and available in wide-lead spacing and SMD option.

Applications

- Telephone set, telephone exchangers
- Sequence controllers
- System appliances, measuring instruments
- Signal transmission between circuits of different potentials and impedances

Schematic

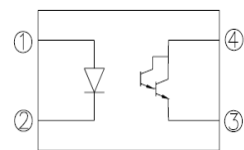

Pin Configuration

1. Anode
2. Cathode
3. Emitter
4. Collector



LIGHTING FOREVER

4 PIN DIP PHOTOTRANSISTOR PHOTOCOUPLER

EL815 Series

Absolute Maximum Ratings ($T_a=25^{\circ}\text{C}$)

Parameter		Symbol	Rating	Unit
Input	Forward current	I_F	60	mA
	Peak forward current (1us, pulse)	I_{FP}	1	A
	Reverse voltage	V_R	6	V
	Power dissipation No derating required up to $T_a = 100^{\circ}\text{C}$	P_D	100	mW
Output	Power dissipation Derating factor (above $T_a = 80^{\circ}\text{C}$)	P_C	150	mW
			5.8	mW/ $^{\circ}\text{C}$
	Collector current	I_C	80	mA
	Collector-Emitter voltage	V_{CEO}	35	V
	Emitter-Collector voltage	V_{ECO}	7	V
Total power dissipation		P_{TOT}	200	mW
Isolation voltage ^{*1}		V_{ISO}	5000	V rms
Operating temperature		T_{OPR}	-55 ~ +110	$^{\circ}\text{C}$
Storage temperature		T_{STG}	-55 ~ +125	$^{\circ}\text{C}$
Soldering temperature ^{*2}		T_{SOL}	260	$^{\circ}\text{C}$

Notes

*1 AC for 1 minute, R.H.= 40 ~ 60% R.H. In this test, pins 1 & 2 are shorted together, and pins 3 & 4 are shorted together.

*2 For 10 seconds.



LIGHTING FOREVER

4 PIN DIP PHOTOTRANSISTOR PHOTOCOUPLER

EL815 Series

Electrical Characteristics ($T_a=25^\circ\text{C}$ unless specified otherwise)

Input

Parameter	Symbol	Min.	Typ.*	Max.	Unit	Condition
Forward voltage	V_F	-	1.2	1.4	V	$I_F = 20\text{mA}$
Reverse current	I_R	-	-	10	μA	$V_R = 4\text{V}$
Input capacitance	C_{in}	-	30	250	pF	$V = 0, f = 1\text{kHz}$

Output

Parameter	Symbol	Min.	Typ.*	Max.	Unit	Condition
Collector-Emitter dark current	I_{CEO}	-	-	1	μA	$V_{CE} = 10\text{V}, I_F = 0\text{mA}$
Collector-Emitter breakdown voltage	BV_{CEO}	35	-	-	V	$I_C = 0.1\text{mA}$
Emitter-Collector breakdown voltage	BV_{ECO}	7	-	-	V	$I_E = 0.1\text{mA}$

Transfer Characteristics ($T_a=25^\circ\text{C}$ unless specified otherwise)

Parameter	Symbol	Min.	Typ.*	Max.	Unit	Condition
Current Transfer ratio	CTR	600	-	7500	%	$I_F = 1\text{mA}, V_{CE} = 2\text{V}$
Collector-Emitter saturation voltage	$V_{CE(sat)}$	-	0.8	1.0	V	$I_F = 20\text{mA}, I_C = 5\text{mA}$
Isolation resistance	R_{IO}	5×10^{10}	-	-	Ω	$V_{IO} = 500\text{Vdc}, 40\sim 60\% \text{ R.H.}$
Floating capacitance	C_{IO}	-	0.6	1.0	pF	$V_{IO} = 0, f = 1\text{MHz}$
Cut-off frequency	f_c	-	6	-	kHz	$V_{CE} = 5\text{V}, I_C = 2\text{mA}$ $R_L = 100\Omega, -3\text{dB}$
Rise time	t_r	-	60	300	μs	$V_{CE} = 2\text{V}, I_C = 10\text{mA},$ $R_L = 100\Omega$
Fall time	t_f	-	53	250	μs	

* Typical values at $T_a = 25^\circ\text{C}$

4 PIN DIP PHOTOTRANSISTOR PHOTOCOUPLER

EL815 Series

Typical Performance Curves

Figure 1. Forward Current vs Forward Voltage

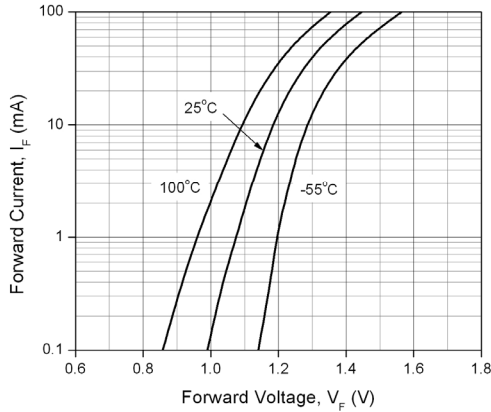

Figure 2. Current Transfer Ratio vs. Ambient Temperature

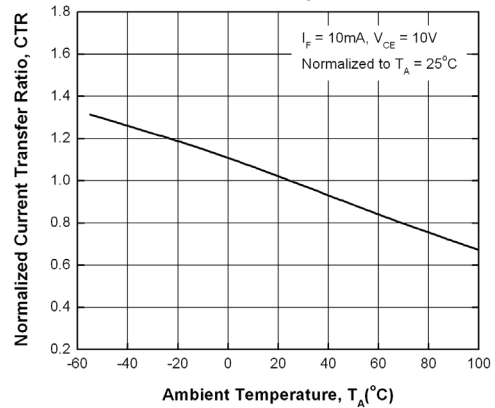

Figure 3. Normalized Current Transfer Ratio vs Forward Current

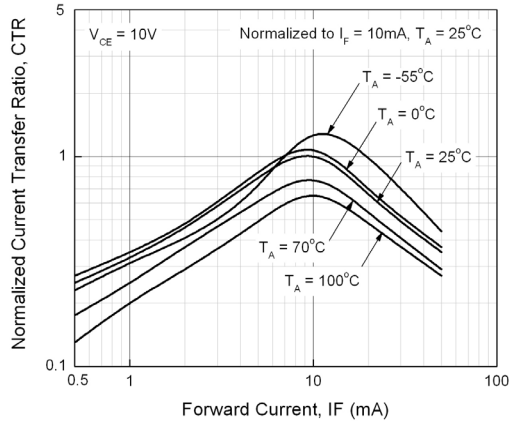

Figure 4. Collector Dark Current vs Ambient Temperature

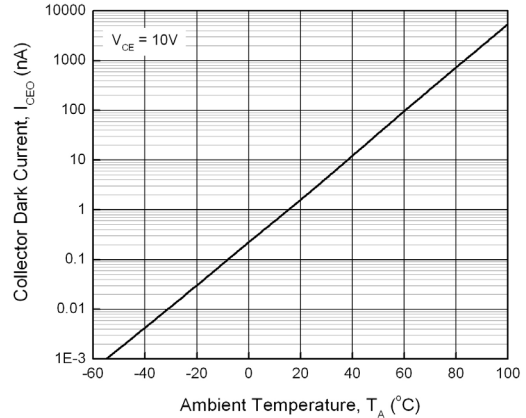

Figure 5. Turn-on Time vs Forward Current

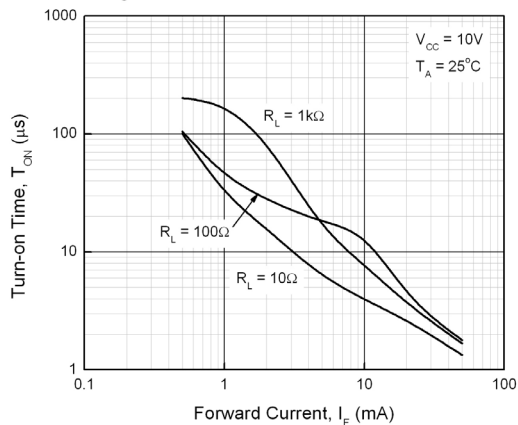
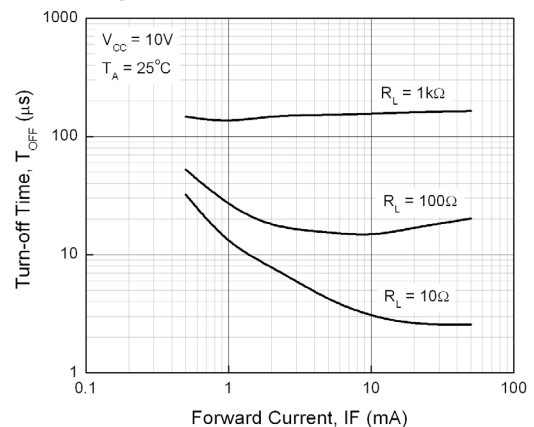

Figure 6. Turn-off Time vs Forward Current



4 PIN DIP PHOTOTRANSISTOR PHOTOCOUPLER

EL815 Series

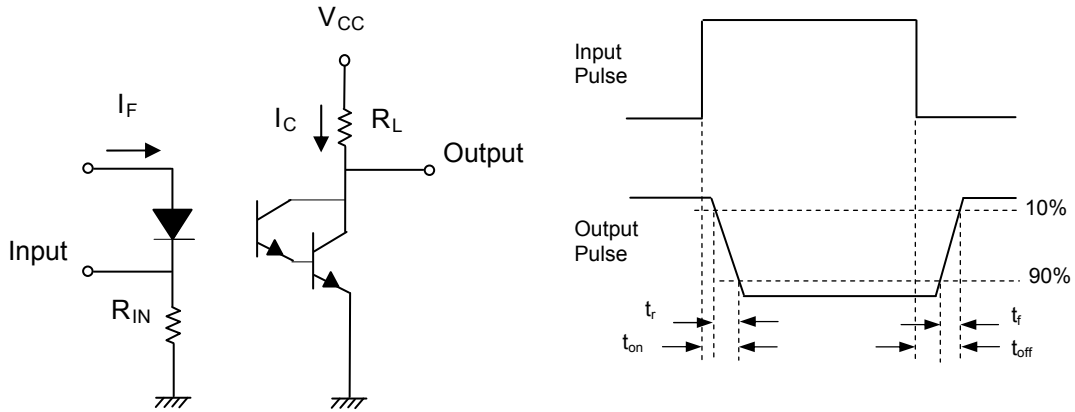

Figure 7. Switching Time Test Circuit & Waveforms



LIGHTING FOREVER

4 PIN DIP PHOTOTRANSISTOR PHOTOCOUPLER

EL815 Series

Order Information

Part Number

EL815(X)(Z)-V

Note

- X = Lead form option (S, S1, M or none)
- Z = Tape and reel option (TA, TB ,TU, TD or none).
- V = VDE safety (optional).

Option	Description	Packing quantity
None	Standard DIP-4	100 units per tube
M	Wide lead bend (0.4 inch spacing)	100 units per tube
S (TA)	Surface mount lead form + TA tape & reel option	1000 units per reel
S (TB)	Surface mount lead form + TB tape & reel option	1000 units per reel
S1 (TA)	Surface mount lead form (low profile) + TA tape & reel option	1000 units per reel
S1 (TB)	Surface mount lead form (low profile) + TB tape & reel option	1000 units per reel
S (TU)	Surface mount lead form + TU tape & reel option	1500 units per reel
S (TD)	Surface mount lead form + TD tape & reel option	1500 units per reel
S1 (TU)	Surface mount lead form (low profile) + TU tape & reel option	1500 units per reel
S1 (TD)	Surface mount lead form (low profile) + TD tape & reel option	1500 units per reel

4 PIN DIP PHOTOTRANSISTOR PHOTOCOUPLER

EL815 Series

Package Drawing

(Dimensions in mm)

Standard DIP Type

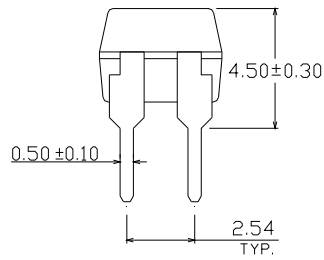
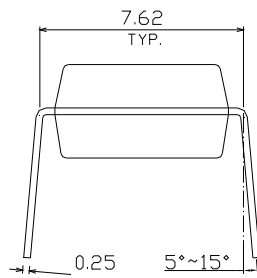
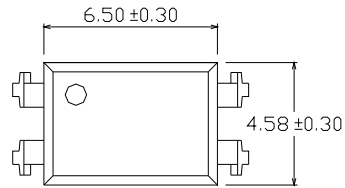

Option M Type

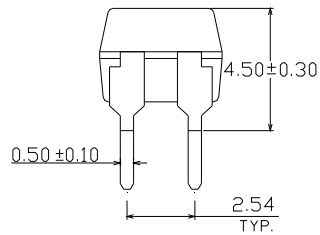
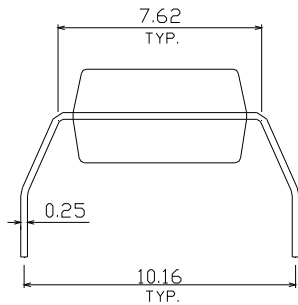
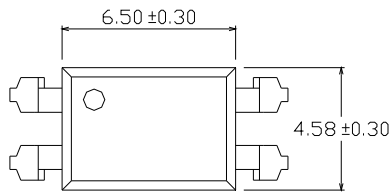

4 PIN DIP PHOTOTRANSISTOR PHOTOCOUPLER

EL815 Series

Option S Type

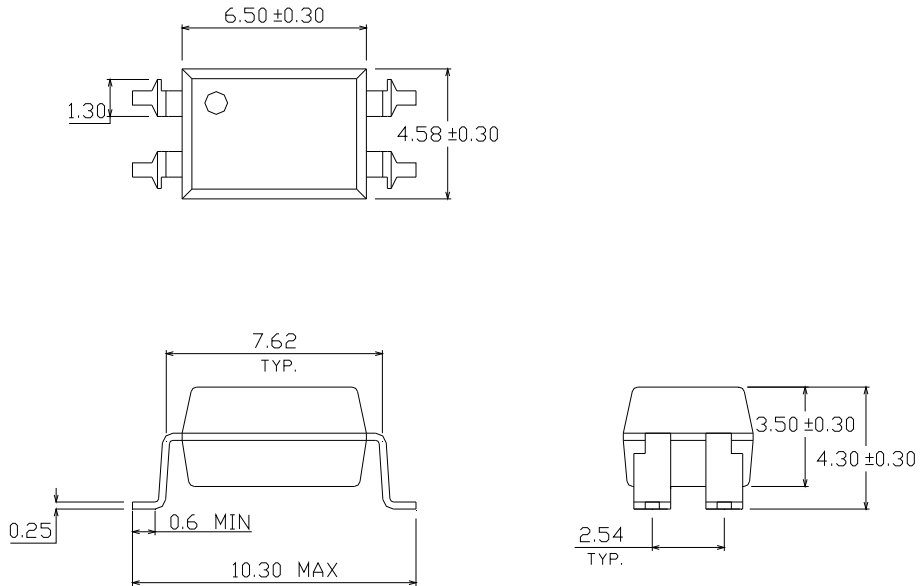

Option S1 Type

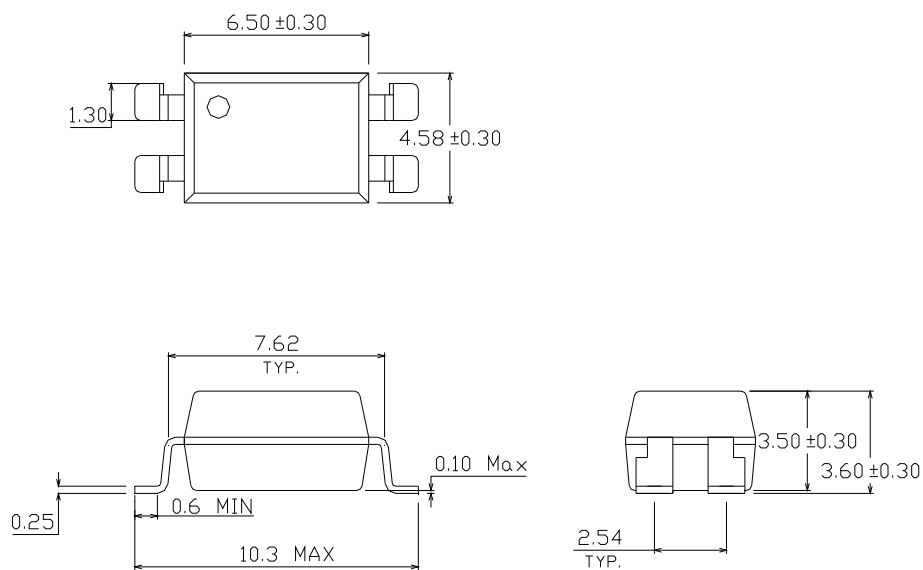

4 PIN DIP PHOTOTRANSISTOR PHOTOCOUPLER

EL815 Series

Recommended pad layout for surface mount leadform

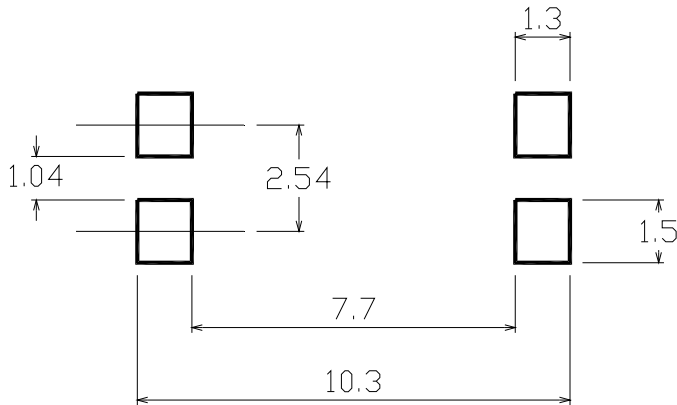

Device Marking



Notes

- EL denotes EVERLIGHT
- 815 denotes Device Number
- F denotes Factory Code (None: China, T: Taiwan)
- R denotes CTR Rank
- Y denotes 1 digit Year code
- WW denotes 2 digit Week code
- V denotes VDE optional

4 PIN DIP PHOTOTRANSISTOR PHOTOCOUPLER

EL815 Series

Tape & Reel Packing Specifications

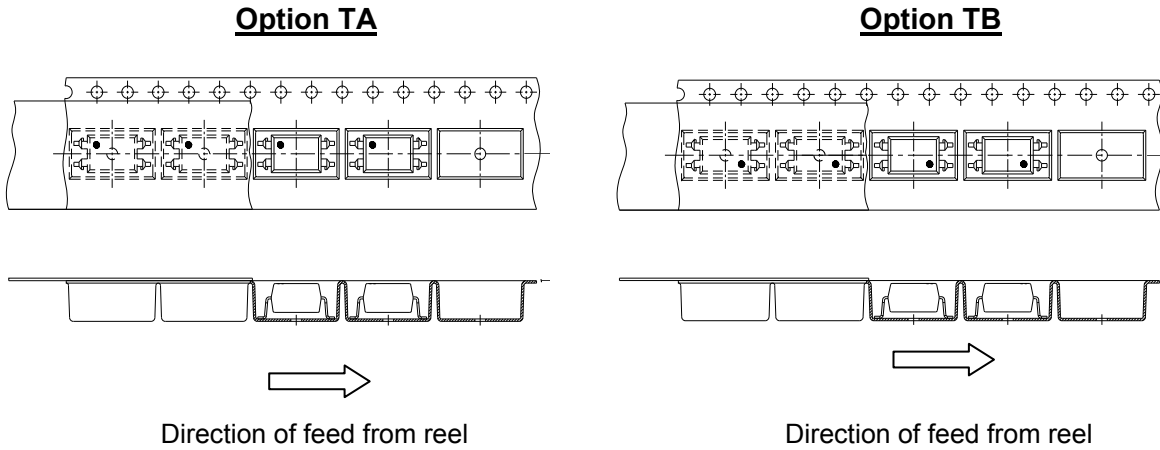

Tape dimensions

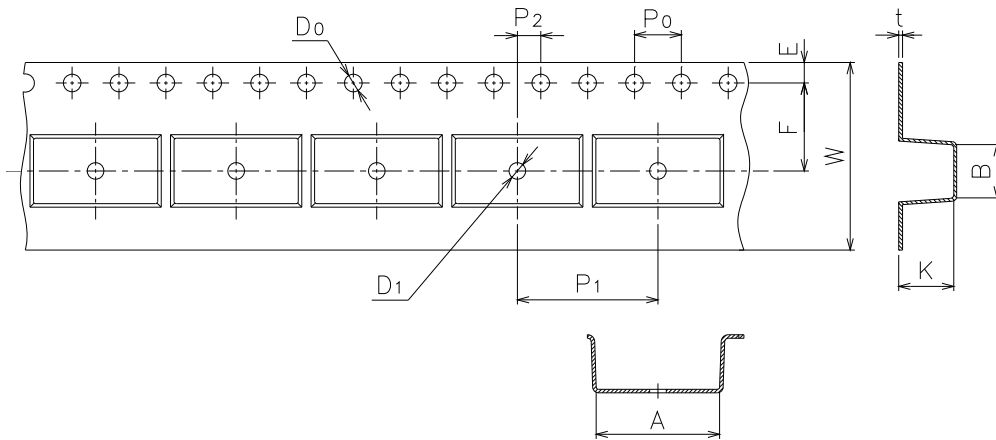

Dimension No.	A	B	Do	D1	E	F
Dimension(mm)	10.4±0.1	4.55±0.1	1.5±0.1	1.5±0.05	1.75±0.1	7.5±0.1
Dimension No.	Po	P1	P2	t	W	K
Dimension(mm)	4.0±0.1	12.0±0.1	2.0±0.1	0.33±0.1	16.0+0.3/ -0.1	4.55±0.1

4 PIN DIP PHOTOTRANSISTOR PHOTOCOUPLER

EL815 Series

Option TD

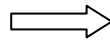
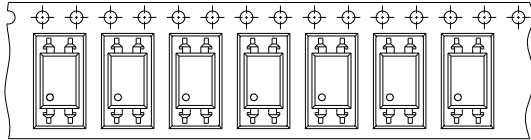

Direction of feed from reel

Option TU

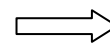
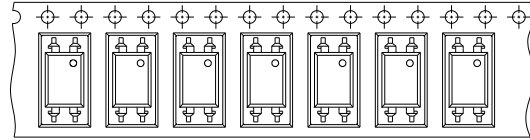

Direction of feed from reel

Tape dimensions

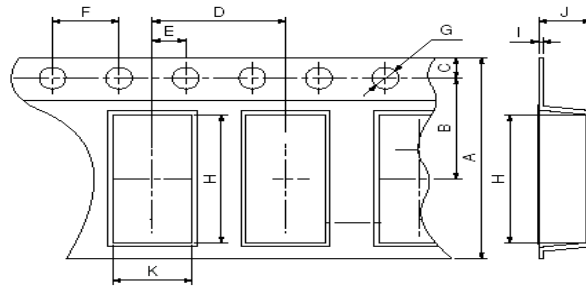

Dimension No.	A	B	C	D	E	F
Dimension(mm)	16.00±0.3	7.5±0.1	1.75±0.1	8.0±0.1	2.0±0.1	4.0±0.1
Dimension No.	G	H	I	J	K	
Dimension(mm)	1.5+0.1/-0	10.4±0.1	0.4±0.05	4.55±0.1	5.1±0.1	



LIGHTING FOREVER

4 PIN DIP PHOTOTRANSISTOR PHOTOCOUPLER

EL815 Series

Solder Reflow Temperature Profile

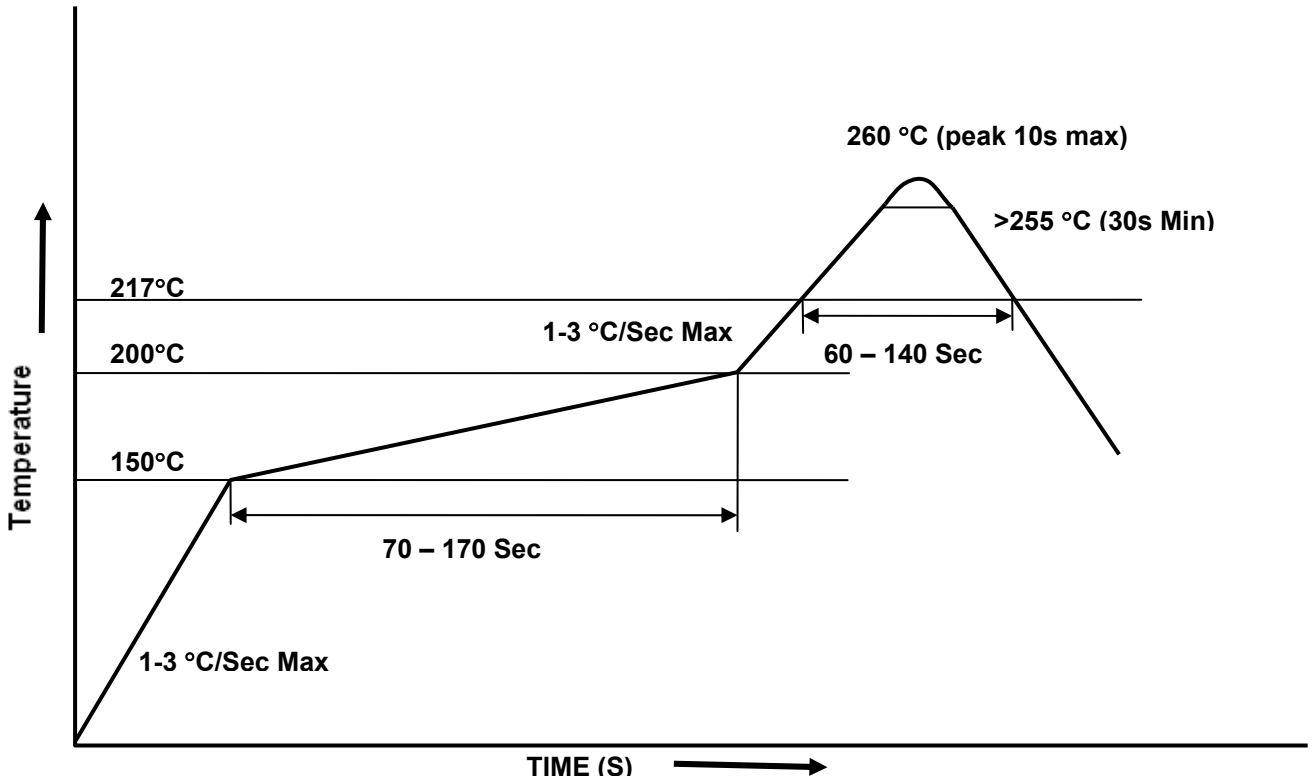



LIGHTING FOREVER

4 PIN DIP PHOTOTRANSISTOR PHOTOCOUPLER

EL815 Series

DISCLAIMER

1. The specifications in this datasheet may be changed without notice. EVERLIGHT reserves the authority on material change for above specification.
2. When using this product, please observe the absolute maximum ratings and the instructions for use as outlined in this datasheet. EVERLIGHT assumes no responsibility for any damage resulting from use of the product which does not comply with the absolute maximum ratings and the instructions included in this datasheet.
3. These specification sheets include materials protected under copyright of EVERLIGHT. Reproduction in any form is prohibited without the specific consent of EVERLIGHT.