

### Features

- High speed 1Mbit/s
- High isolation voltage between input and output ( $V_{iso}=3750 V_{rms}$ )
- High CMR 15KV/us at  $V_{CM}=1500V$  (ELM453)
- Guaranteed performance from 0°C to 70°C
- Wide operating temperature range of -40°C to 85°C
- Pb free and RoHS and Halogen free compliant
- cUL approved (No. E214129)
- VDE approved (No. 40028116)
- SEMKO approved
- NEMKO approved
- DEMKO approved
- FIMKO approved

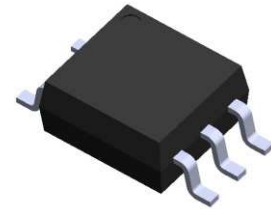

### Description

The ELM452 and ELM453 devices each consist of an infrared emitting diode, optically coupled to a high speed photo detector transistor. A separate connection for the photodiode bias and output-transistor collector increase the speed by several orders of magnitude over conventional phototransistor couplers by reducing the base-collector capacitance of the input transistor.

The devices are packaged in industry standard 5pin SOP packages and are suitable for surface mounting.

### Applications

- Line receivers
- Field bus communication and control.
- Power transistor isolation in motor drives
- Replacement for low speed phototransistor photo couplers
- High speed logic ground isolation
- Analog signal ground isolation

### Schematic

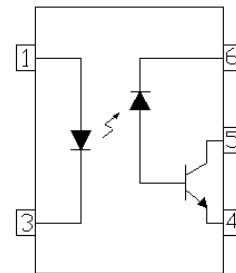

### Pin Configuration

1. Anode
3. Cathode
4. Gnd
5. Vout
6. VCC

### Absolute Maximum Ratings ( $T_a=25^{\circ}\text{C}$ unless otherwise noted)

Parameter		Symbol	Rating	Unit
Input	Forward current	$I_F$	25	mA
	Peak forward current (50% duty, 1ms P.W)	$I_{FP}$	50	mA
	Peak transient current ( $\leq 1\mu\text{s}$ P.W, 300pps)	$I_{Ftrans}$	1	A
	Reverse voltage	$V_R$	5	V
	Power dissipation	$P_{IN}$	45	mW
Output	Power dissipation	$P_O$	100	mW
	Average Output current	$I_{O(AVG)}$	8	mA
	Peak Output current	$I_{O(PK)}$	16	mA
	Output voltage	$V_O$	-0.5 to 20	V
	Supply voltage	$V_{CC}$	-0.5 to 30	V
Isolation voltage <sup>*1</sup>		$V_{ISO}$	3750	V rms
Operating temperature		$T_{OPR}$	-40 ~ +85	$^{\circ}\text{C}$
Storage temperature		$T_{STG}$	-55 ~ +125	$^{\circ}\text{C}$
Soldering temperature <sup>*2</sup>		$T_{SOL}$	260	$^{\circ}\text{C}$

#### Notes

\*1 AC for 1 minute, R.H.= 40 ~ 60% R.H. In this test, pins 1 & 3 are shorted together, and pins 4, 5 & 6 are shorted together.

\*2 For 10 seconds.

### Electrical Characteristics ( $T_A=0$ to $70^\circ\text{C}$ unless specified otherwise)

#### Input

Parameter	Symbol	Min.	Typ.*	Max.	Unit	Conditions
Forward voltage	$V_F$	-	1.45	1.8	V	$I_F = 16\text{mA}$
Reverse Voltage	$V_R$	5.0	-	-	V	$I_R = 10\mu\text{A}$
Temperature coefficient of forward voltage	$\Delta V_F/\Delta T_A$	-	-1.6	-	mV/ $^\circ\text{C}$	$I_F = 16\text{mA}$

#### Output

Parameter	Symbol	Min.	Typ.*	Max.	Unit	Conditions
Logic High Output Current	$I_{OH}$	-	0.001	0.5	$\mu\text{A}$	$I_F = 0\text{mA}$ , $V_O = V_{CC} = 5.5\text{V}$ , $T_A = 25^\circ\text{C}$
		-	0.001	1		$I_F = 0\text{mA}$ , $V_O = V_{CC} = 15\text{V}$ , $T_A = 25^\circ\text{C}$
		-	-	50		$I_F = 0\text{mA}$ , $V_O = V_{CC} = 15\text{V}$
Logic Low Supply Current	$I_{CCL}$	-	100	200	$\mu\text{A}$	$I_F = 16\text{mA}$ , $V_O = \text{Open}$ , $V_{CC} = 15\text{V}$
Logic High Supply Current	$I_{CCH}$	-	0.05	1	$\mu\text{A}$	$I_F = 0\text{mA}$ , $V_O = \text{Open}$ , $V_{CC} = 15\text{V}$ , $T_A = 25^\circ\text{C}$
		-	-	2		$I_F = 0\text{mA}$ , $V_O = \text{Open}$ , $V_{CC} = 15\text{V}$

#### Transfer Characteristics

Parameter	Symbol	Min.	Typ.*	Max.	Unit	Conditions
Current Transfer Ratio	CTR	20	-	50	%	$I_F = 16\text{mA}$ , $V_O = 0.4\text{V}$ , $V_{CC} = 4.5\text{V}$ , $T_A = 25^\circ\text{C}$
		15	-	-		$I_F = 16\text{mA}$ , $V_O = 0.5\text{V}$ , $V_{CC} = 4.5\text{V}$
Logic Low Output Voltage	$V_{OL}$	-	-	0.4	V	$I_F = 16\text{mA}$ , $I_O = 3\text{mA}$ , $V_{CC} = 4.5\text{V}$ , $T_A = 25^\circ\text{C}$
		-	-	0.5		$I_F = 16\text{mA}$ , $I_O = 2.4\text{mA}$ , $V_{CC} = 4.5\text{V}$

### Switching Characteristics ( $T_A=0$ to $70^\circ\text{C}$ unless specified otherwise, $V_{CC}=5\text{V}$ )

Parameter	Symbol	Min.	Typ.*	Max.	Unit	Conditions	
Propagation Delay Time to Logic Low <sup>(*3)</sup> (Fig.8)	$T_{PHL}$	-	0.4	0.8	$\mu\text{s}$	$I_F=16\text{mA}$ , $R_L=1.9\text{K}\Omega$ , $T_A=25^\circ\text{C}$	
		-	-	1.0		$I_F=16\text{mA}$ , $R_L=1.9\text{K}\Omega$	
Propagation Delay Time to Logic High <sup>(*3)</sup> (Fig.8)	$T_{PLH}$	-	0.35	0.8	$\mu\text{s}$	$I_F=16\text{mA}$ , $R_L=1.9\text{K}\Omega$ , $T_A=25^\circ\text{C}$	
		-	-	1.0		$I_F=16\text{mA}$ , $R_L=1.9\text{K}\Omega$	
Common Mode Transient Immunity at Logic High <sup>(*4)</sup> (Fig.9)	ELM452	$CM_H$	5,000	-	-	$V/\mu\text{s}$	$I_F = 0\text{mA}$ , $V_{CM}=10\text{Vp-p}$ , $R_L=1.9\text{K}\Omega$ , $T_A = 25^\circ\text{C}$
	ELM453		15,000	-	-		$I_F = 0\text{mA}$ , $V_{CM}=1500\text{Vp-p}$ , $R_L=1.9\text{K}\Omega$ , $T_A = 25^\circ\text{C}$
Common Mode Transient Immunity at Logic Low <sup>(*4)</sup> (Fig.9)	ELM452	$CM_L$	5,000	-	-	$V/\mu\text{s}$	$I_F = 16\text{mA}$ , $V_{CM}=10\text{Vp-p}$ , $R_L=1.9\text{K}\Omega$ , $T_A = 25^\circ\text{C}$
	ELM453		15,000	-	-		$I_F = 16\text{mA}$ , $V_{CM}=1500\text{Vp-p}$ , $R_L=1.9\text{K}\Omega$ , $T_A=25^\circ\text{C}$

### Typical Performance Curves

Figure 1. Forward Current vs Forward Voltage

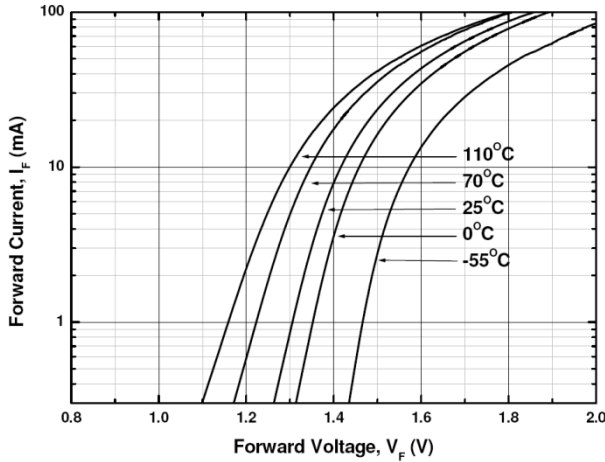

Figure 2. Current Transfer Ratio vs Forward Current

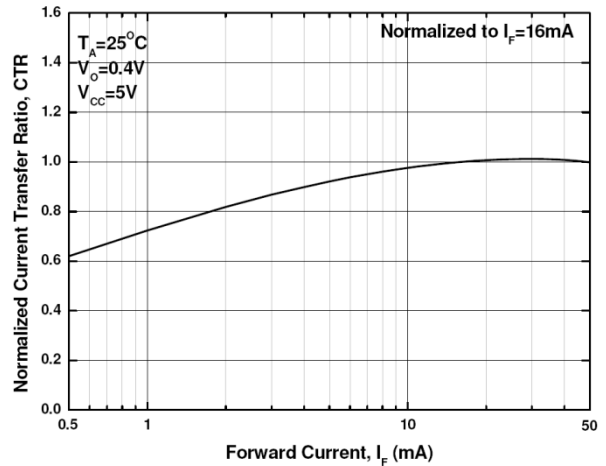

Figure 3. Current Transfer Ratio vs Ambient Temperature

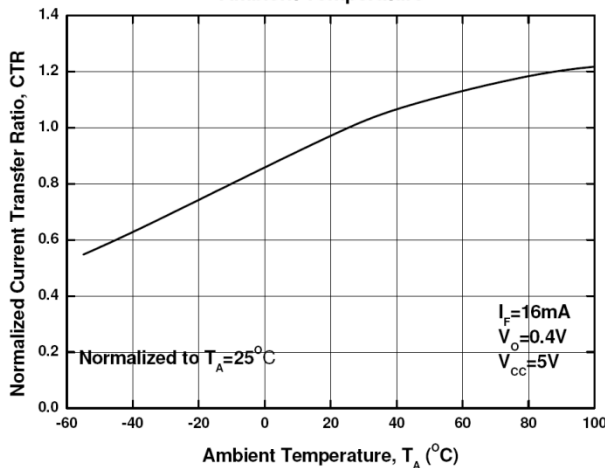

Figure 4. Output Current vs Output Voltage

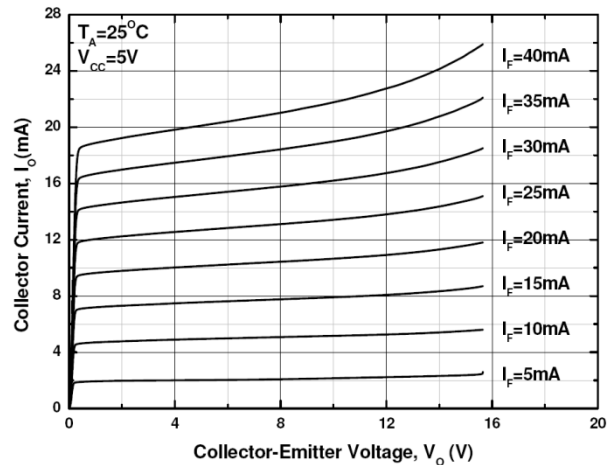

Figure 5. Logic High Output Current vs Ambient Temperature

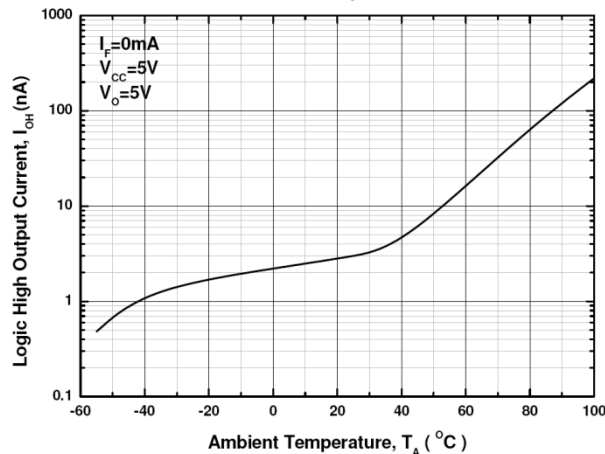

Figure 6. Propagation Delay vs. Load Resistance

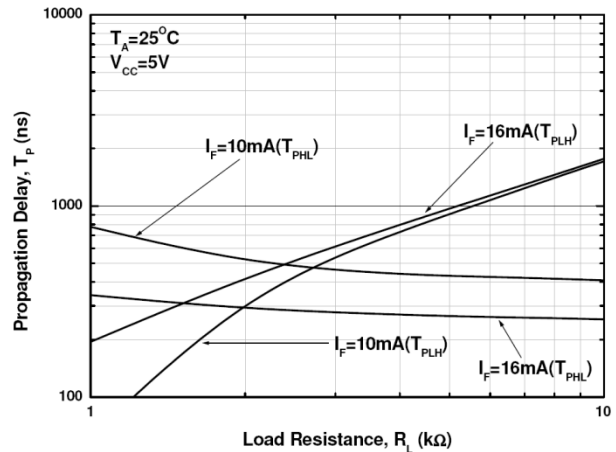

Figure 7. Propagation Delay vs. Temperature

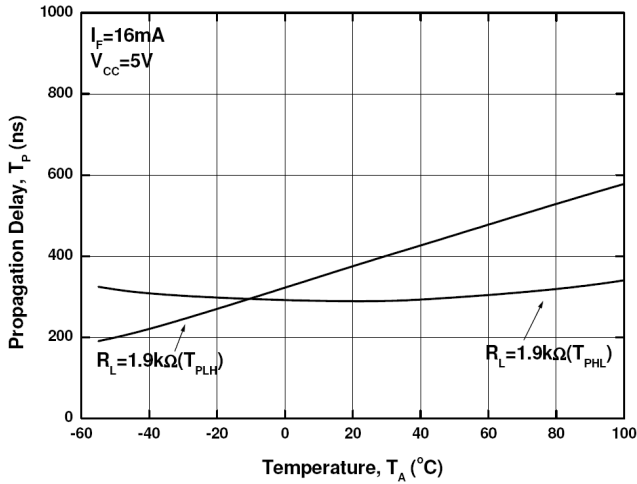

Figure 8. Frequency Response

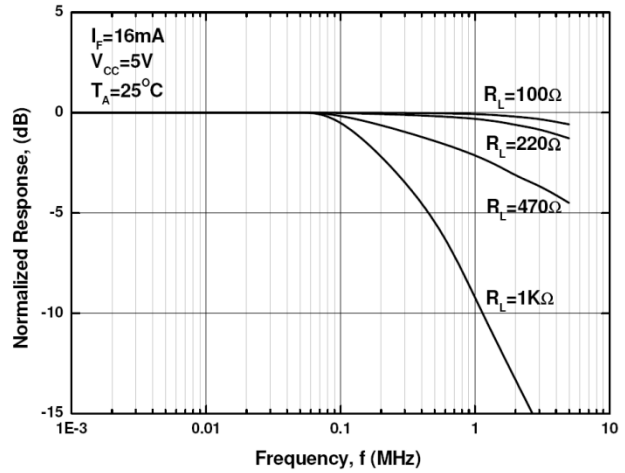

Figure 9 Switching Time Test Circuit & Waveform

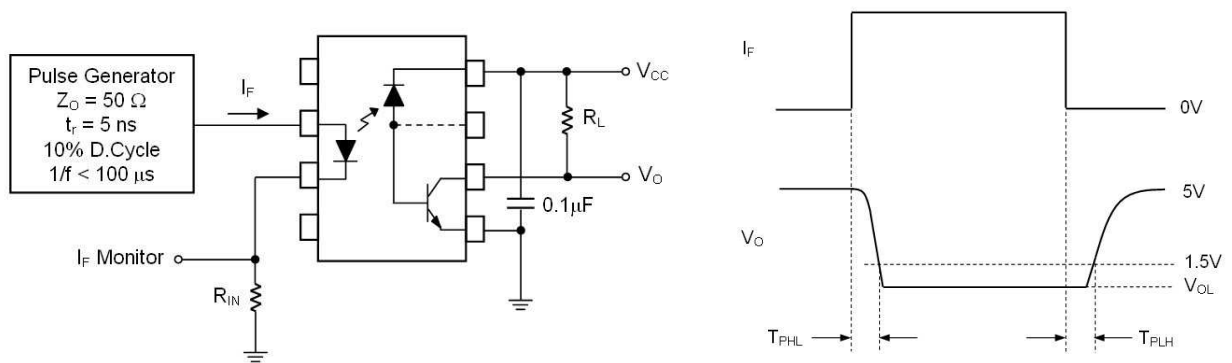
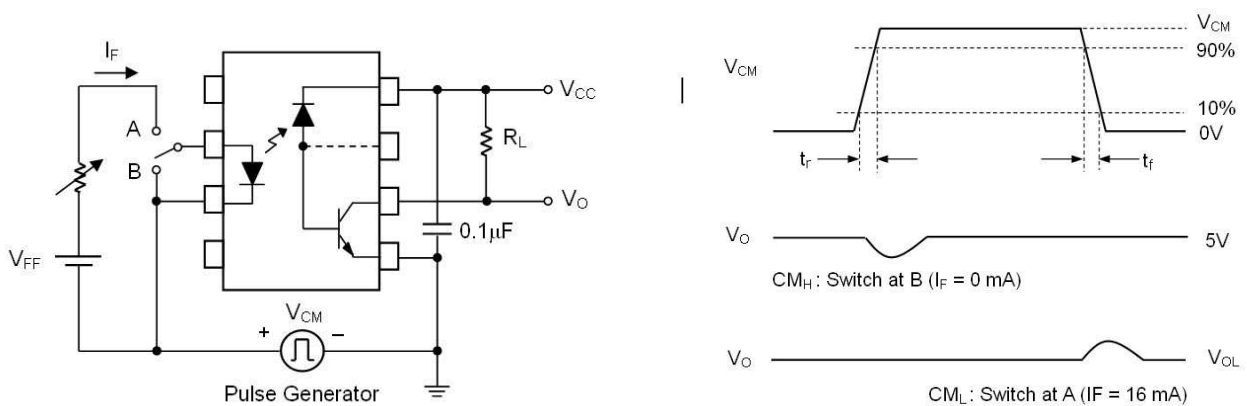

Figure 10 Transient Immunity Test Circuit &



**Note:**

\*3 Common mode transient immunity in logic high level is the maximum tolerable (positive)  $dV_{cm}/dt$  on the leading edge of the common mode pulse signal VCM, to assure that the output will remain in a logic high state (i.e.,  $V_O > 2.0V$ ).

Common mode transient immunity in logic low level is the maximum tolerable (negative)  $dV_{cm}/dt$  on the trailing edge of the common mode pulse signal, VCM, to assure that the output will remain in a logic low state (i.e.,  $V_O < 0.8V$ ).

**Order Information****Part Number**

# ELM45X(Z)-V

**Note**

- X = Part No. (2 or 3)
- Z = Tape and reel option (TA, TB or none)
- V = VDE (optional)

Option	Description	Packing quantity
None	Standard	100 units per tube
-V	Standard + VDE	100 units per tube
(TA)	TA tape & reel option	3000 units per reel
(TB)	TB tape & reel option	3000 units per reel
(TA)-V	TA tape & reel option + VDE	3000 units per reel
(TB)-V	TB tape & reel option + VDE	3000 units per reel

### Package Drawing

(Dimensions in mm)

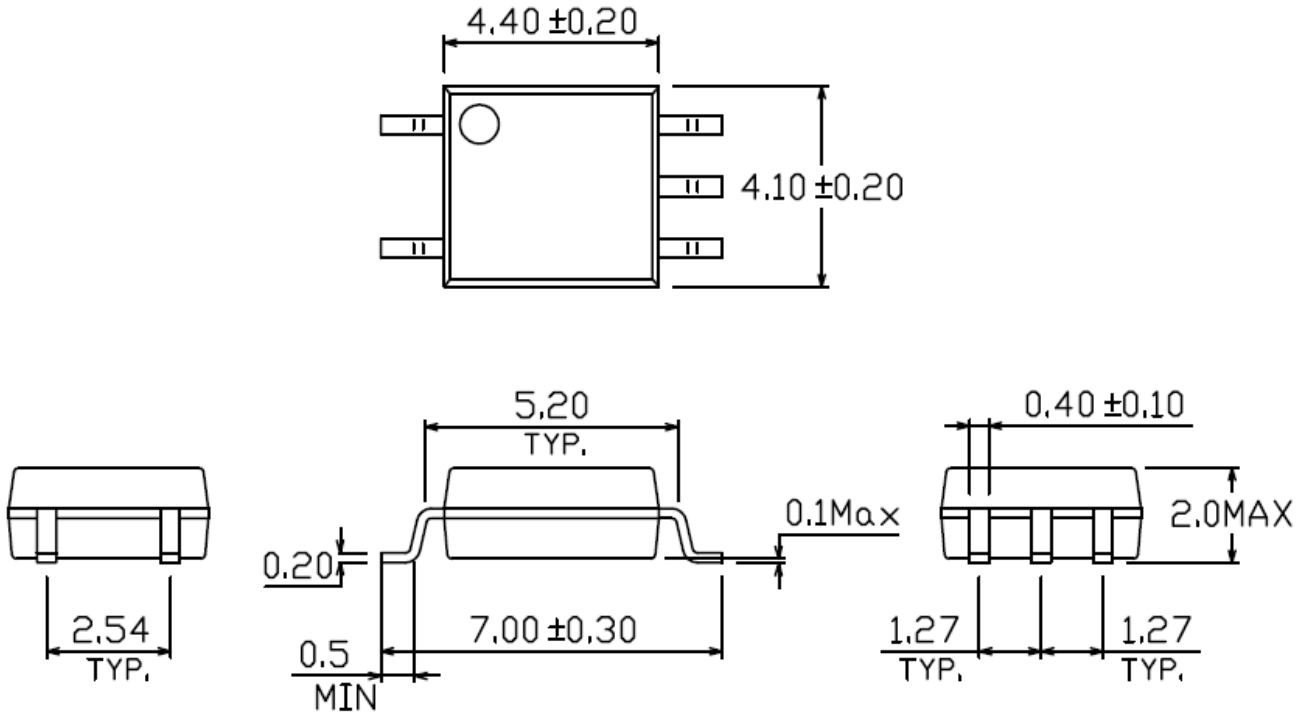

### Recommended pad layout for surface mount leadform

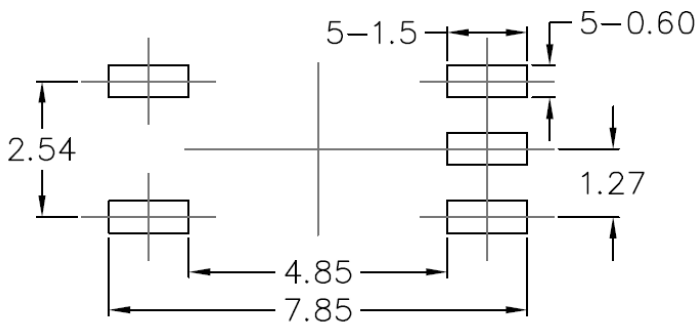



### Device Marking

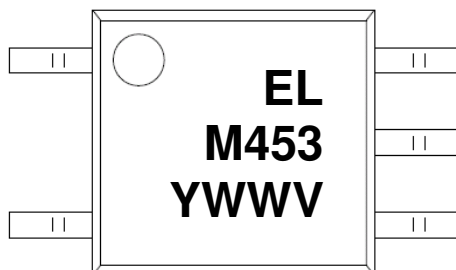

### Notes

EL	denotes EVERLOGHT
M453	denotes Device Number
Y	denotes 1 digit Year code
WW	denotes 2 digit Week code
V	denotes VDE (optional)

### Tape & Reel Packing Specifications

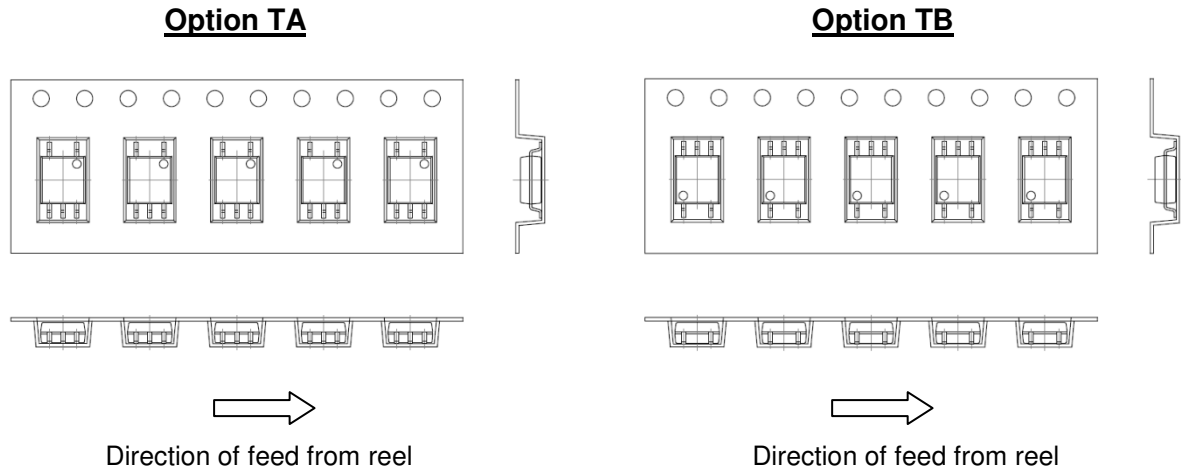

### Tape dimensions

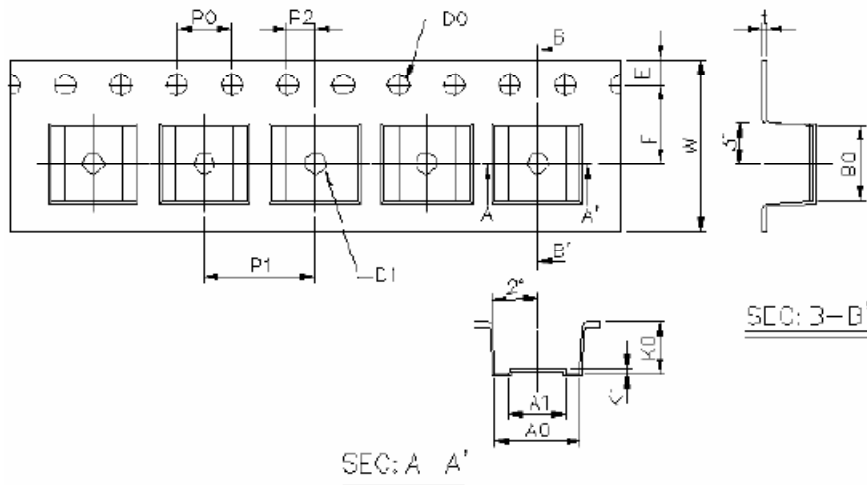

Dimension No.	<b>A0</b>	<b>A1</b>	<b>B0</b>	<b>D0</b>	<b>D1</b>	<b>E</b>	<b>F</b>
Dimension(mm)	6.2±0.1	4.1±0.1	5.28±0.1	1.5±0.1	1.5±0.3	1.75±0.1	5.5±0.1
Dimension No.	<b>Po</b>	<b>P1</b>	<b>P2</b>	<b>t</b>	<b>W</b>	<b>K0</b>	<b>K1</b>
Dimension(mm)	4.0±0.1	8.0±0.1	2.0±0.1	0.4±0.1	12.0+0.3/ -0.1	3.7±0.1	0.3±0.1

### Solder Reflow Temperature Profile

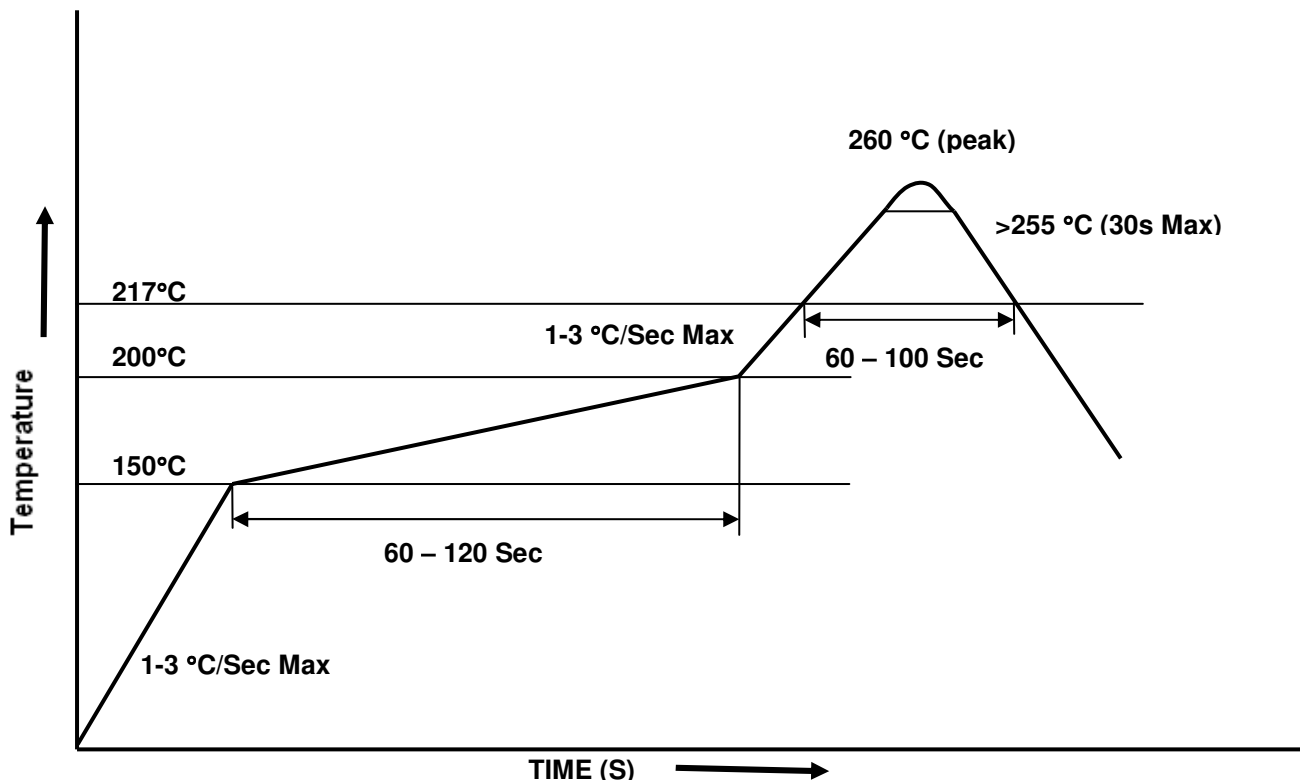

### DISCLAIMER

1. Above specification may be changed without notice. EVERLIGHT will reserve authority on material change for above specification.
2. When using this product, please observe the absolute maximum ratings and the instructions for using outlined in these specification sheets. EVERLIGHT assumes no responsibility for any damage resulting from use of the product which does not comply with the absolute maximum ratings and the instructions included in these specification sheets.
3. These specification sheets include materials protected under copyright of EVERLIGHT corporation. Please don't reproduce or cause anyone to reproduce them without EVERLIGHT's consent.