



LIGHTING FOREVER

# 8 PIN SOP PHOTOTRANSISTOR PHOTOCOUPLER

## EL20X / 21X series

### Features

- Current transfer ratios in offered in narrow ranges
  - EL205: 40-80%
  - EL206: 63-125%
  - EL207: 100-200%
  - EL208: 160-320%
  - EL211: >20%
  - EL212: >50%
  - EL213: >100%
- High isolation voltage between input and output  
Viso = 3750 Vrms
- Operating temperature range of -55 to +110°C
- High BVceo of 80V
- Standard SO-8 footprint package
- Pb free and RoHS compliant.
- UL approved (No. E214129)
- VDE approval (pending)
- SEMKO approved
- NEMKO approved
- DEMKO approved
- FIMKO approved
- CSA approved (No. 2007189)

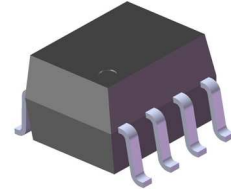

### Schematic

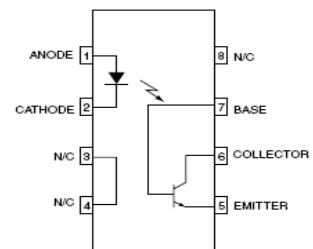

1. Anode
2. Cathode
3. No Connection
4. No Connection
5. Emitter
6. Collector
7. Base
8. No Connection

### Description

The EL20X and EL21X series contain an infrared emitting diode optically coupled to a phototransistor detector. The devices are packaged in an 8-pin small outline package which conforms to the standard SO-8 footprint.

### Applications

- Feedback Control Circuits
- Interfacing and coupling systems of different potentials and impedances
- General Purpose Switching Circuits
- Monitor and Detection Circuits



LIGHTING FOREVER

# 8 PIN SOP PHOTOTRANSISTOR PHOTOCOUPLER

## EL20X / 21X series

### Absolute Maximum Ratings ( $T_a=25^{\circ}\text{C}$ )

Parameter		Symbol	Rating	Unit
Input	Forward current	$I_F$	60	mA
	Peak forward current ( $t = 10\mu\text{s}$ )	$I_{FM}$	1	A
	Reverse voltage	$V_R$	6	V
	Power dissipation No Derating needed	$P_D$	90	mW
Output	Collector power dissipation No derating needed	$P_C$	150	mW
	Collector-Emitter voltage	$V_{CEO}$	80	V
	Collector-Base voltage	$V_{CBO}$	80	V
	Emitter-Collector voltage	$V_{ECO}$	7	V
Total power dissipation		$P_{tot}$	240	mW
Isolation voltage <sup>*1</sup>		$V_{iso}$	3750	Vrms
Operating temperature		$T_{opr}$	-55~+110	$^{\circ}\text{C}$
Storage temperature		$T_{stg}$	-55~+150	$^{\circ}\text{C}$
Soldering temperature <sup>*2</sup>		$T_{sol}$	260	$^{\circ}\text{C}$

#### Notes

\*1 AC for 1 minute, R.H.= 40 ~ 60% R.H. In this test, pins 1, 2 & 3 are shorted together, and pins 4, 5 & 6 are shorted together.

\*2 For 10 seconds.



LIGHTING FOREVER

# 8 PIN SOP PHOTOTRANSISTOR PHOTOCOUPLER

## EL20X / 21X series

### Electrical Characteristics (T<sub>a</sub>=25°C unless specified otherwise)

#### Input

Parameter	Symbol	Min.	Typ.*	Max.	Unit	Condition
Forward voltage	V <sub>F</sub>	-	1.3	1.5	V	I <sub>F</sub> = 10mA
Reverse current	I <sub>R</sub>	-	0.1	100	μA	V <sub>R</sub> = 6V
Input capacitance	C <sub>in</sub>	-	13	-	pF	V = 0, f = 1MHz

#### Output

Parameter	Symbol	Min.	Typ.*	Max.	Unit	Condition
Collector-Emitter dark current	I <sub>CEO</sub>	-	5.0	50	nA	V <sub>CE</sub> = 10V, I <sub>F</sub> = 0mA
Collector-Emitter breakdown voltage	BV <sub>CEO</sub>	80	-	-	V	I <sub>C</sub> = 0.1mA
Emitter-Collector breakdown voltage	BV <sub>ECO</sub>	7	-	-	V	I <sub>E</sub> = 0.1mA
Collector-Emitter capacitance	C <sub>CE</sub>	-	8	-	pF	VCE = 0V, f = 1MHz

#### Transfer Characteristics

Parameter	Symbol	Min.	Typ.*	Max.	Unit	Condition
Current Transfer Ratio	EL205	40	-	80	%	I <sub>F</sub> = 10mA, V <sub>CE</sub> = 5V
	EL206	63	-	125		
	EL207	100	-	200		
	EL208	160	-	320		
	EL211	20	-	-		
	EL212	50	-	-		
	EL213	100	-	-		
Current Transfer Ratio	EL205	13	25	-	%	I <sub>F</sub> = 1mA, V <sub>CE</sub> = 5V
	EL206	22	40	-		
	EL207	34	60	-		
	EL208	56	95	-		
	EL215	20	50	-		
	EL216	50	80	-		
	EL217	100	130	-		
Collector-emitter saturation voltage	V <sub>CE(sat)</sub>	-	-	0.4	V	I <sub>F</sub> = 10mA, I <sub>C</sub> = 2mA
Isolation resistance	R <sub>IO</sub>	-	10 <sup>11</sup>	-	Ω	V <sub>IO</sub> = 500Vdc
Input-output capacitance	C <sub>IO</sub>	-	0.5	-	pF	V <sub>IO</sub> = 0, f = 1MHz



LIGHTING FOREVER

# 8 PIN SOP PHOTOTRANSISTOR PHOTOCOUPLER

## EL20X / 21X series

### Transfer Characteristics ( Continue )

Turn-on time	$T_{on}$	-	3.0	-	$\mu s$	$V_{CC} = 10V,$ $I_C = 2mA, R_L = 100\Omega$
Turn-off time	$T_{off}$	-	3.0	-		
Rise time	$T_r$	-	1.6	-		
Fall time	$T_f$	-	2.2	-		

\* Typical values at  $T_a = 25^\circ C$



LIGHTING FOREVER

# 8 PIN SOP PHOTOTRANSISTOR PHOTOCOUPLER

## EL20X / 21X series

### Typical Performance Curves

Figure 1. Forward Current vs Forward Voltage

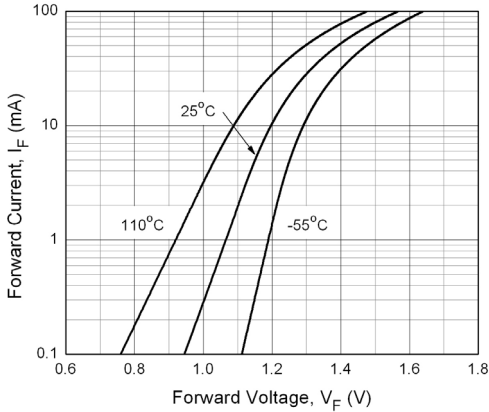

Figure 2. Normalized Collector Current vs. Forward Current

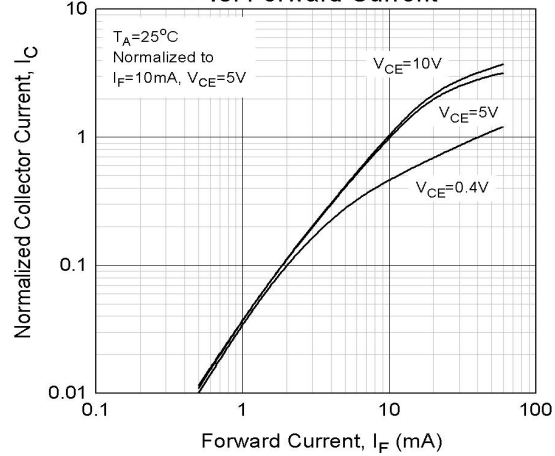

Figure 3. Normalized Collector Current vs Ambient Temperature

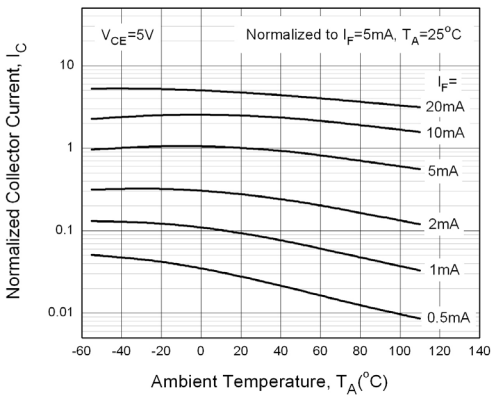

Figure 4. Collector Dark Current vs Ambient Temperature

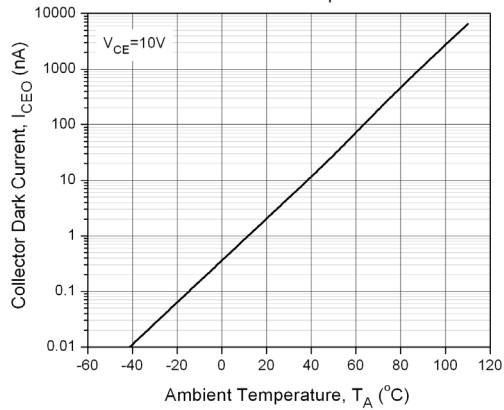

Figure 5. Collector Current vs Collector-Emitter Voltage

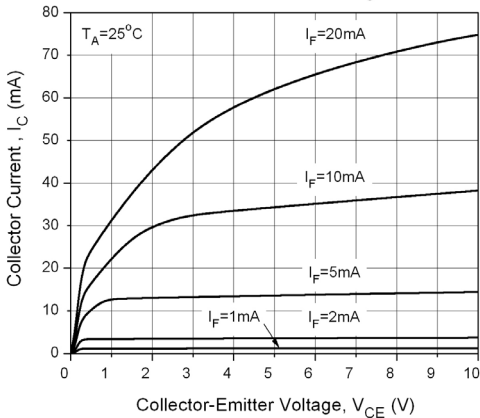
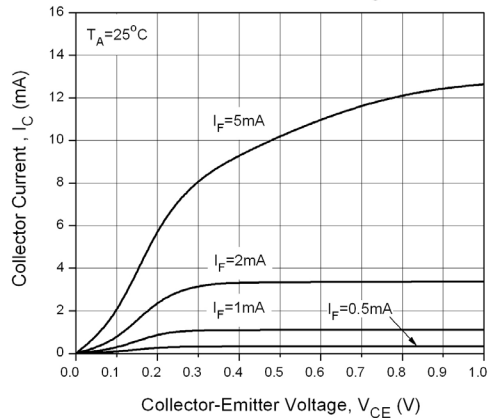

Figure 6. Collector Current vs Collector-Emitter Voltage



# 8 PIN SOP PHOTOTRANSISTOR PHOTOCOUPLER

EL20X / 21X series

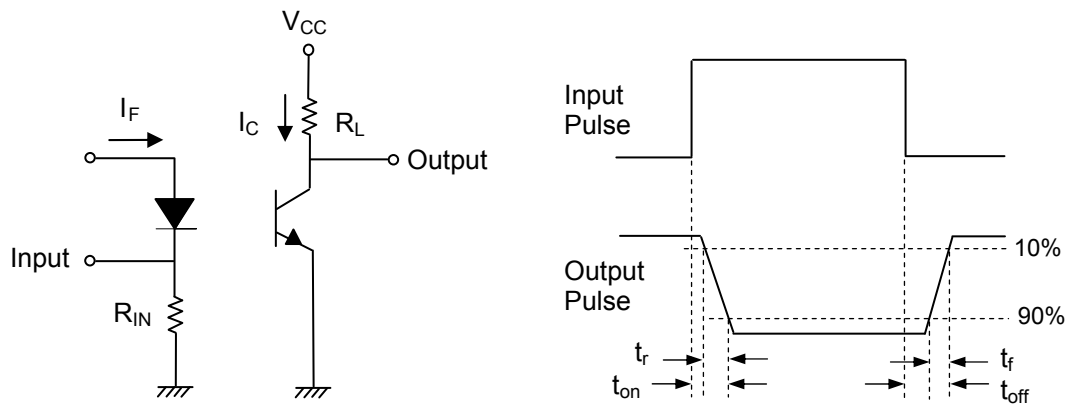
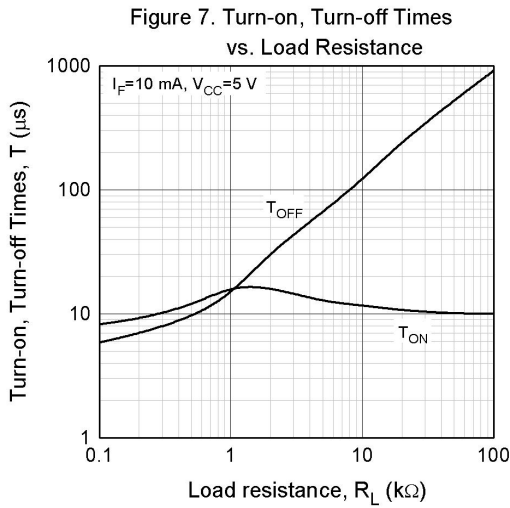

Figure 8. Switching Time Test Circuit & Waveforms



LIGHTING FOREVER

# 8 PIN SOP PHOTOTRANSISTOR PHOTOCOUPLER

## EL20X / 21X series

### Order Information

Part Number

# EL2XX(Y)-V

**Note**

XX = Part no. (05, 06, 07, 08, 11, 12, 13, 15, 16 or 17)

Y = Tape and reel option (TA, TB or none).

V = VDE safety (Optional)

Option	Description	Packing quantity
None	Standard	100 units per tube
-V	Standard + VDE	100 units per tube
(TA)	TA tape & reel option	2000 units per reel
(TB)	TB tape & reel option	2000 units per reel
(TA)-V	TA tape & reel option + VDE	2000 units per reel
(TB)-V	TB tape & reel option + VDE	2000 units per reel



LIGHTING FOREVER

# 8 PIN SOP PHOTOTRANSISTOR PHOTOCOUPLER

## EL20X / 21X series

### Package Drawings (Dimensions in mm)

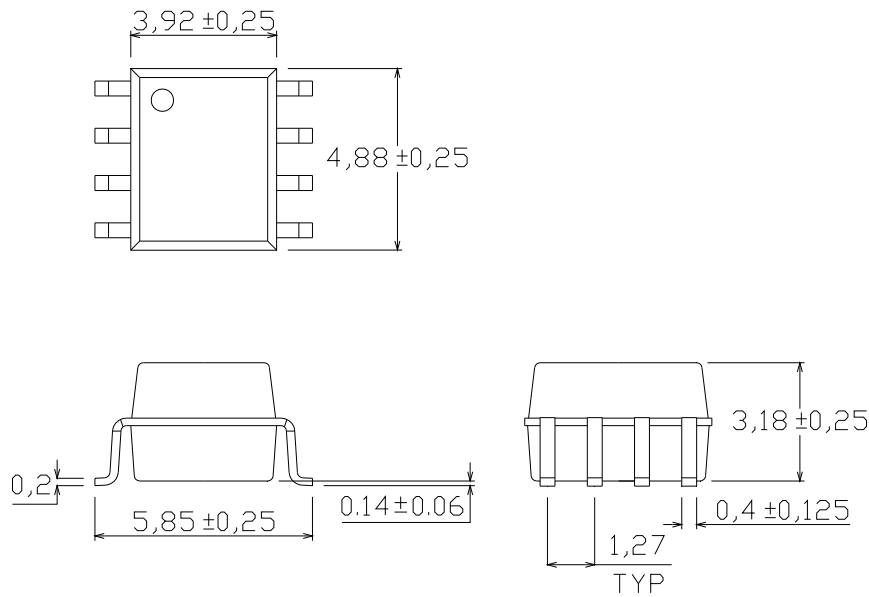

### Recommended pad layout for surface mount leadfrom

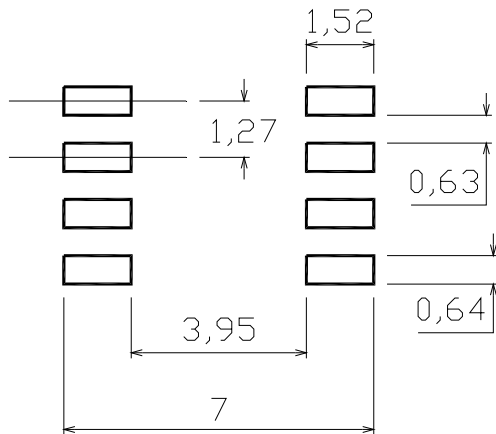





LIGHTING FOREVER

# 8 PIN SOP PHOTOTRANSISTOR PHOTOCOUPLER

EL20X / 21X series

## Device Marking

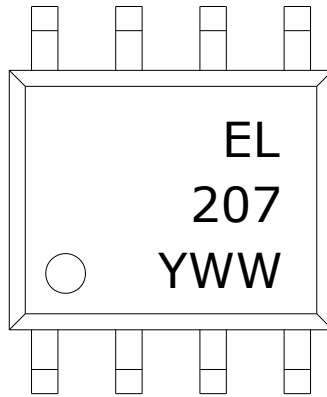

## Notes

EL denotes Everlight  
207 denotes Part Number  
Y denotes 1 digit Year code  
WW denotes 2 digit Week code



LIGHTING FOREVER

# 8 PIN SOP PHOTOTRANSISTOR PHOTOCOUPLER

EL20X / 21X series

## Tape & Reel Packing Specifications

### Option TA

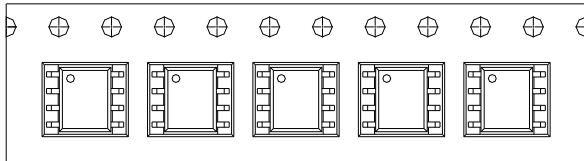

### Option TB

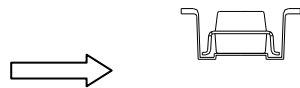
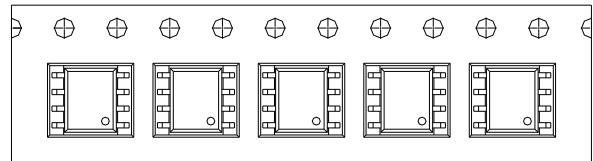

Direction of feed from reel



Direction of feed from reel

## Tape dimensions

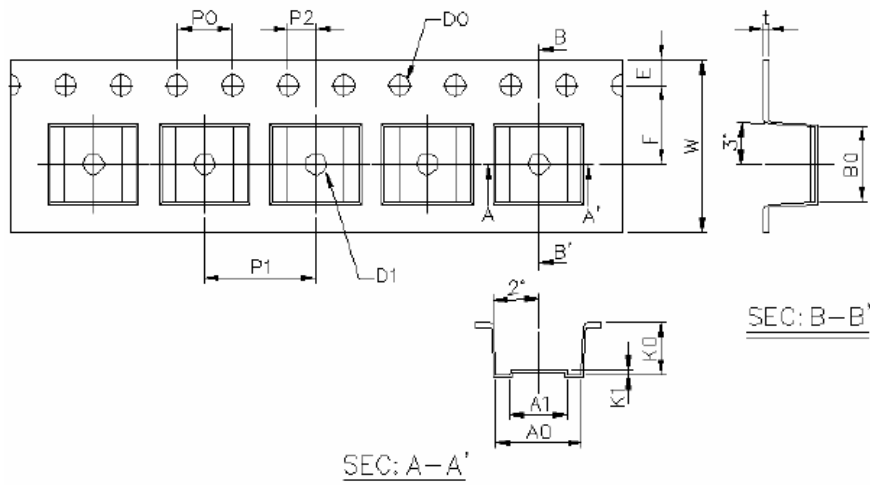

Dimension No.	<b>A0</b>	<b>A1</b>	<b>B0</b>	<b>D0</b>	<b>D1</b>	<b>E</b>	<b>F</b>
Dimension(mm)	6.2±0.1	4.1±0.1	5.28±0.1	1.5±0.1	1.5±0.3	1.75±0.1	5.5±0.1
Dimension No.	<b>Po</b>	<b>P1</b>	<b>P2</b>	<b>t</b>	<b>W</b>	<b>K0</b>	<b>K1</b>
Dimension(mm)	4.0±0.1	8.0±0.1	2.0±0.1	0.4±0.1	12.0+0.3/ -0.1	3.7±0.1	0.3±0.1



LIGHTING FOREVER

# 8 PIN SOP PHOTOTRANSISTOR PHOTOCOUPLER

## EL20X / 21X series

### Solder Reflow Temperature Profile

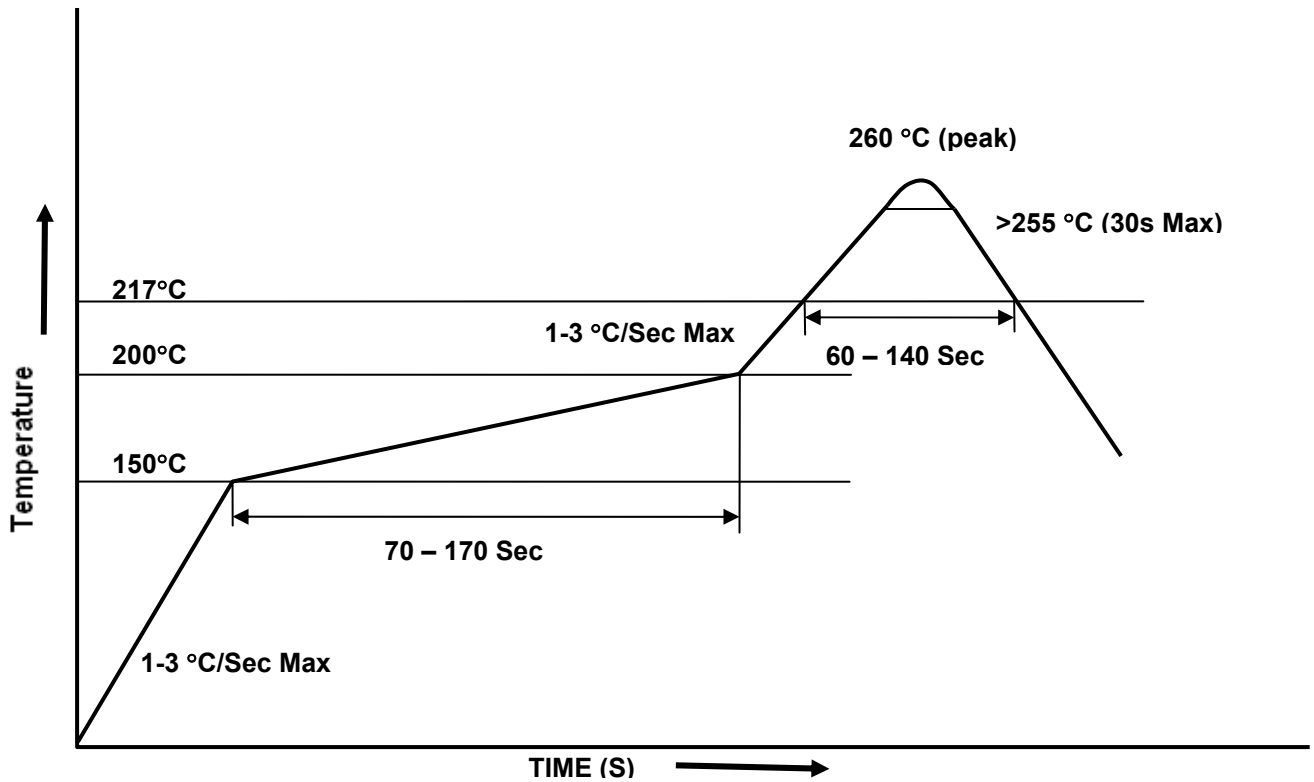



LIGHTING FOREVER

## 8 PIN SOP PHOTOTRANSISTOR PHOTOCOUPLER

**EL20X / 21X series**

---

### DISCLAIMER

1. The specifications in this datasheet may be changed without notice. EVERLIGHT reserves the authority on material change for above specification.
2. When using this product, please observe the absolute maximum ratings and the instructions for use as outlined in this datasheet. EVERLIGHT assumes no responsibility for any damage resulting from use of the product which does not comply with the absolute maximum ratings and the instructions included in this datasheet.
3. These specification sheets include materials protected under copyright of EVERLIGHT. Reproduction in any form is prohibited without the specific consent of EVERLIGHT.