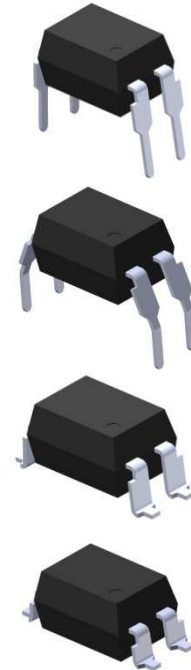


## 4 PIN DIP ZERO CROSS TRIAC DRIVER PHOTOCOUPLER

### Features:

- Peak breakdown voltage
  - 400V: ELT304X
  - 600V: ELT306X
  - 800V: ELT308X
- High isolation voltage between input and output (Viso=5000 V rms )
- Zero voltage crossing
- Pb free and RoHS compliant.
- UL approved (No.E214129)
- VDE approved (No.132249)
- SEMKO approved
- NEMKO approved
- DEMKO approved
- FIMKO approved
- CSA approved



### Description

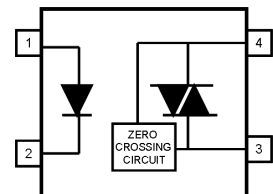
The ELT304X, ELT306X and ELT308X series of devices each consist of a GaAs infrared emitting diode optically coupled to a monolithic silicon zero voltage crossing photo triac.

They are designed for use with a discrete power triac in the interface of logic systems to equipment powered from 110 to 380 VAC lines, such as solid-state relays, industrial controls, motors, solenoids and consumer appliances.

### Applications

- Solenoid/valve controls
- Light controls
- Static power switch
- AC motor drivers
- E.M. contactors
- Temperature controls
- AC Motor starters

### Schematic



### Pin Configuration

1. Anode
2. Cathode
3. Terminal
4. Terminal

**4 PIN DIP ZERO CROSS TRIAC DRIVER  
PHOTOCOUPLER**

**Absolute Maximum Ratings (T<sub>a</sub>=25 °C)**

Parameter		Symbol	Rating	Unit	
Input	Forward current	I <sub>F</sub>	60	mA	
	Reverse voltage	V <sub>R</sub>	6	V	
	Power dissipation	P <sub>D</sub>	100	mW	
Output	Off-state Output Terminal Voltage	V <sub>DRM</sub>	ELT304X	400	V
			ELT306X	600	
			ELT308X	800	
	Peak Repetitive Surge Current	I <sub>TSM</sub>	1	A	
	Power dissipation	P <sub>D</sub>	300	mW	
Isolation voltage *1		V <sub>iso</sub>	5000	V rms	
Total power dissipation		P <sub>D</sub>	330	mW	
Operating temperature		T <sub>opr</sub>	-55~+100	°C	
Storage temperature		T <sub>stg</sub>	-55~+125	°C	
Soldering temperature *2		T <sub>sol</sub>	260	°C	

Notes

\*1 AC for 1 minute, R.H.= 40 ~ 60% R.H. In this test, pins 1, 2 are shorted together, and pins 3, 4 are shorted together.

\*2 For 10 seconds.

## 4 PIN DIP ZERO CROSS TRIAC DRIVER PHOTOCOUPLER

Electrical Characteristics ( $T_a=25^\circ\text{C}$  unless specified otherwise)

### Input

Parameter	Symbol	Min.	Typ.*	Max.	Unit	Condition
Forward voltage	$V_F$	-	-	1.5	V	$I_F = 30\text{mA}$
Reverse Leakage current	$I_R$	-	-	10	$\mu\text{A}$	$V_R = 6\text{V}$

### Output

Parameter	Symbol	Min.	Typ.*	Max.	Unit	Condition
Peak Blocking Current	ELT304X	-	-	100	nA	$V_{\text{DRM}} = \text{Rated } V_{\text{DRM}}$ $I_F = 0\text{mA}$
	ELT306X/308X			500		
Peak On-state Voltage	$V_{\text{TM}}$	-	-	3	V	$I_{\text{TM}}=100\text{mA peak, } I_F=\text{Rated } I_{\text{FT}}$
Critical Rate of Rise of off-state Voltage	ELT304X /306X	dv/dt	1000	-	V/ $\mu\text{s}$	$V_{\text{PEAK}} = \text{Rated } V_{\text{DRM}}, I_F=0$ (Fig. 10)
	ELT308X		600	-		
Inhibit Voltage (MT1-MT2 voltage above which device will not trigger)	$V_{\text{INH}}$	-	-	20	V	$I_F = \text{Rated } I_{\text{FT}}$
Leakage in Inhibited State	$I_{\text{DRM2}}$	-	-	500	$\mu\text{A}$	$I_F = \text{Rated } I_{\text{FT}}, V_{\text{DRM}} = \text{Rated } V_{\text{DRM}}, \text{off state}$

### Transfer Characteristics

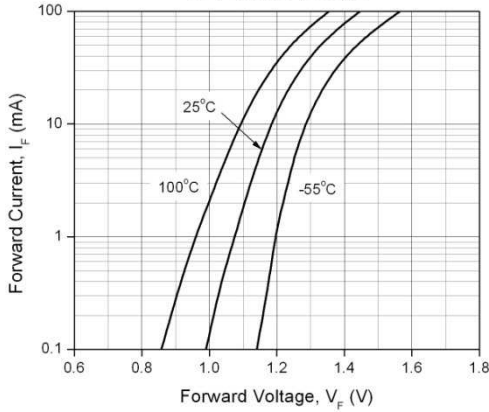
Parameter	Symbol	Min.	Typ.*	Max.	Unit	Condition	
LED Trigger Current	ELT3042 ELT3062 ELT3082	$I_{\text{FT}}$	-	-	10	mA	Main terminal Voltage=3V
	ELT3043 ELT3063 ELT3083				5		
	ELT3044 ELT3064 ELT3084				3		
Holding Current	$I_H$	-	280	-	$\mu\text{A}$		

\* Typical values at  $T_a = 25^\circ\text{C}$

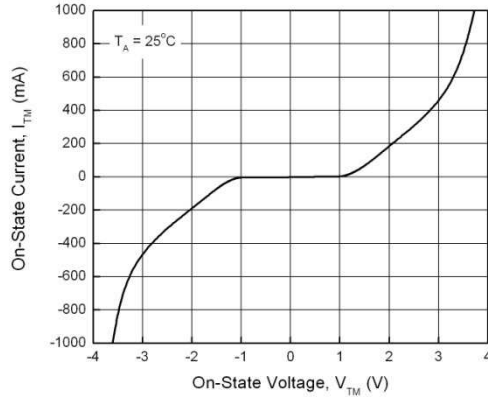
# 4 PIN DIP ZERO CROSS TRIAC DRIVER PHOTOCOUPLER

## Typical Performance Curves

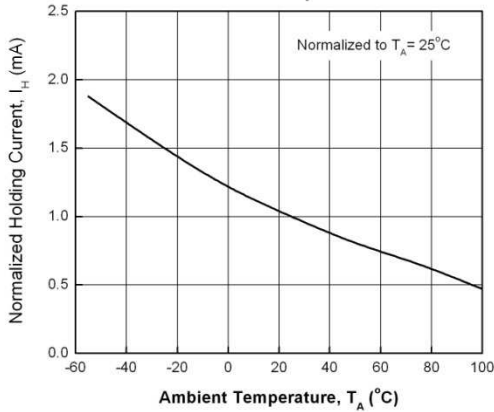
**Figure 1. Forward Current vs Forward Voltage**



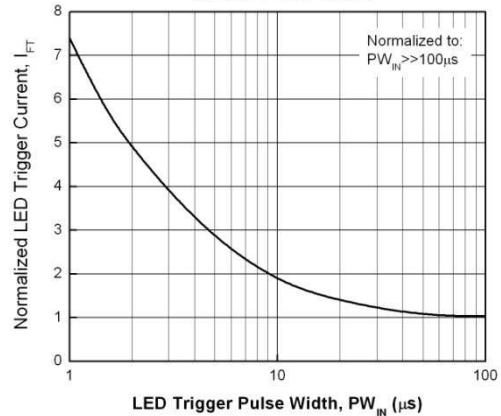
**Figure 2. On-State Characteristics**



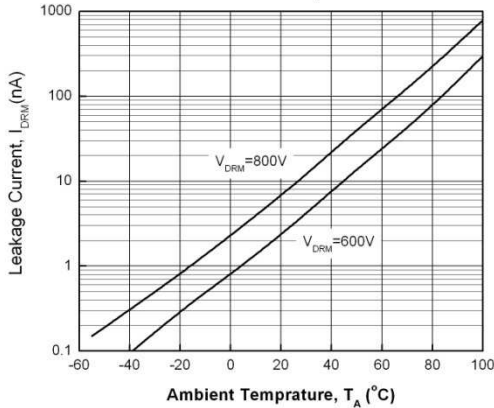
**Figure 3. Holding Current vs. Ambient Temperature**



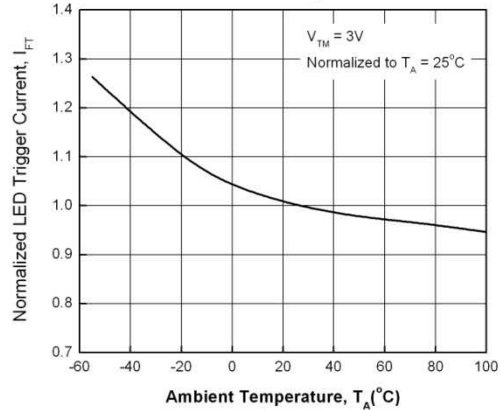
**Figure 4. LED Current Required to Trigger vs. LED Pulse Width**



**Figure 5. Leakage Current vs. Ambient Temperature**

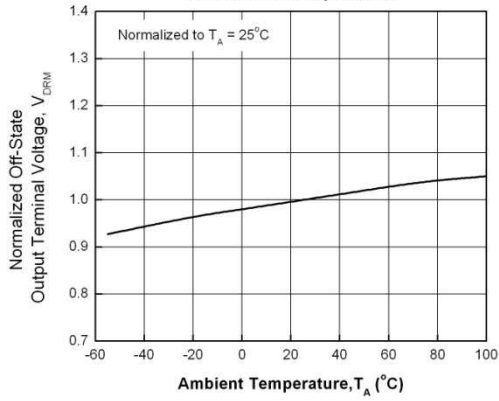


**Figure 6. LED Trigger Current vs. Ambient Temperature**

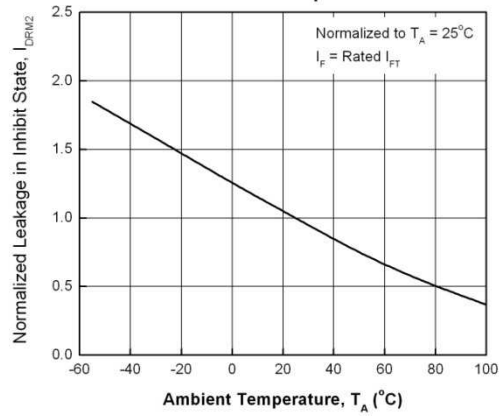


### 4 PIN DIP ZERO CROSS TRIAC DRIVER PHOTOCOUPLER

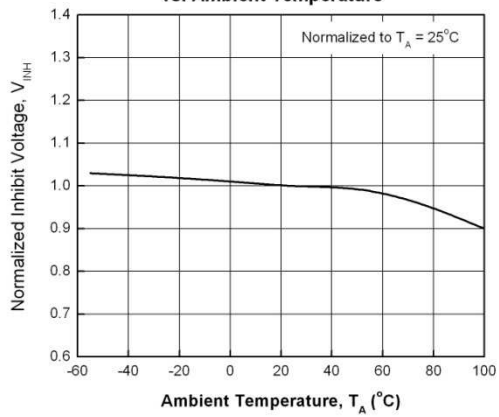
**Figure 7. Off-State Output Terminal Voltage vs. Ambient Temperature**



**Figure 8. Leakage in Inhibit State vs. Ambient Temperature**

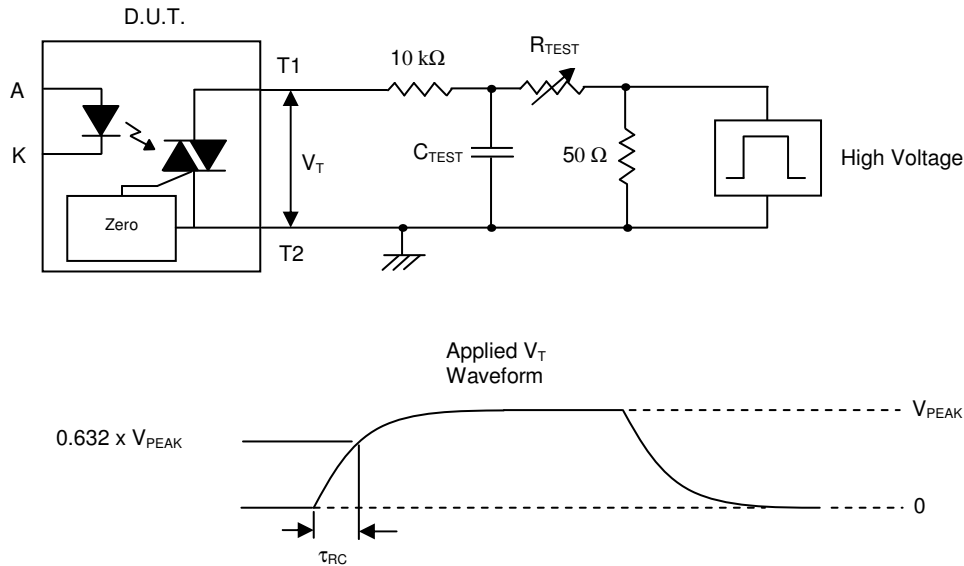


**Figure 9. Inhibit Voltage vs. Ambient Temperature**



**4 PIN DIP ZERO CROSS TRIAC DRIVER  
 PHOTOCOUPLER**

**Figure 10. Static dv/dt Test Circuit & Waveform**



**Measurement Method**

The high voltage pulse is set to the required  $V_{PEAK}$  value and applied to the D.U.T. output side through the RC circuit above. LED current is not applied. The waveform  $V_T$  is monitored using a x100 scope probe. By varying  $R_{TEST}$ , the  $dv/dt$  (slope) is increased, until the D.U.T. is observed to trigger (waveform collapses). The  $dv/dt$  is then decreased until the D.U.T. stops triggering. At this point,  $\tau_{RC}$  is recorded and the  $dv/dt$  calculated.

$$dv/dt = \frac{0.632 \times V_{PEAK}}{\tau_{RC}}$$

For example,  $V_{PEAK} = 600V$  for ELT306X series. The  $dv/dt$  value is calculated as follows:

$$dv/dt = \frac{0.63 \times 600}{\tau_{RC}} = \frac{378}{\tau_{RC}}$$

**4 PIN DIP ZERO CROSS TRIAC DRIVER  
PHOTOCOUPLER****Order Information****Part Number****ELT304X(Y)(Z)-V**or **ELT306X(Y)(Z)-V**or **ELT308X(Y)(Z)-V**Note

X = Part No. (2, 3 or 4)

Y = Lead form option (S, S1, M or none)

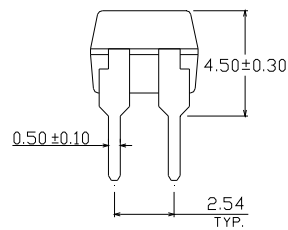
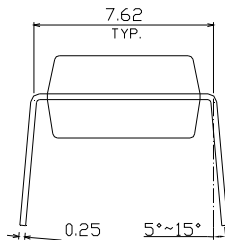
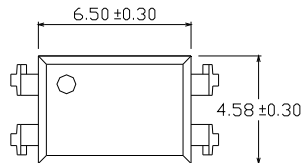
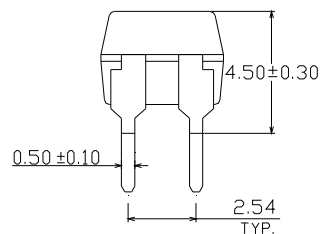
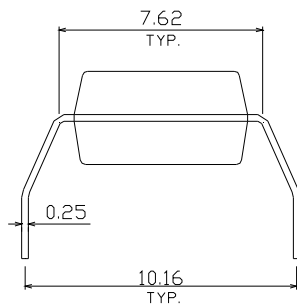
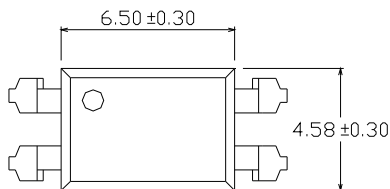
Z = Tape and reel option (TA, TB or none).

V = VDE safety approved option

Option	Description	Packing quantity
None	Standard DIP-4	100 units per tube
M	Wide lead bend (0.4 inch spacing)	100 units per tube
S (TA)	Surface mount lead form + TA tape & reel option	1000 units per reel
S (TB)	Surface mount lead form + TB tape & reel option	1000 units per reel
S1 (TA)	Surface mount lead form (low profile) + TA tape & reel option	1000 units per reel
S1 (TB)	Surface mount lead form (low profile) + TB tape & reel option	1000 units per reel
S (TU)	Surface mount lead form + TU tape & reel option	1500 units per reel
S (TD)	Surface mount lead form + TD tape & reel option	1500 units per reel
S1 (TU)	Surface mount lead form (low profile) + TU tape & reel option	1500 units per reel
S1 (TD)	Surface mount lead form (low profile) + TD tape & reel option	1500 units per reel

**4 PIN DIP ZERO CROSS TRIAC DRIVER  
PHOTOCOUPLER****Package Drawings**

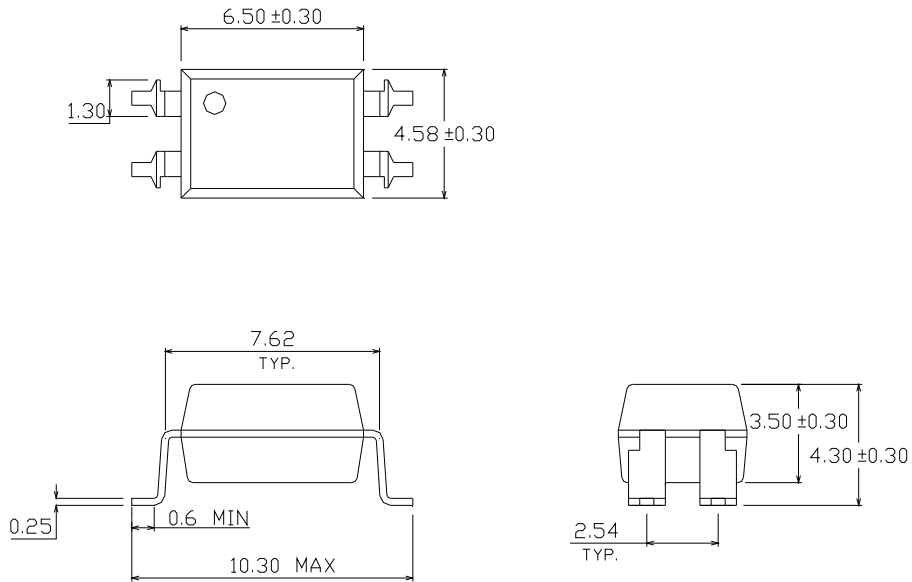
(Dimensions in mm)

**Standard DIP Type****Option M Type**

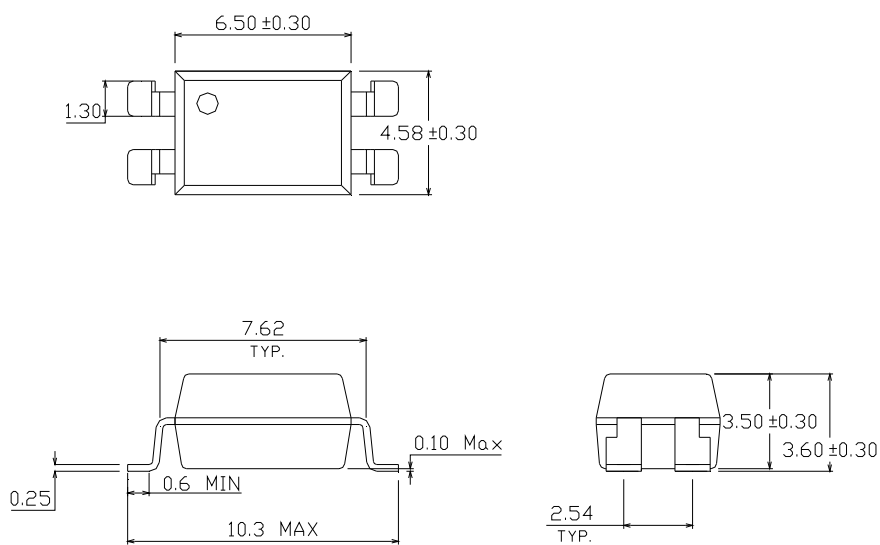


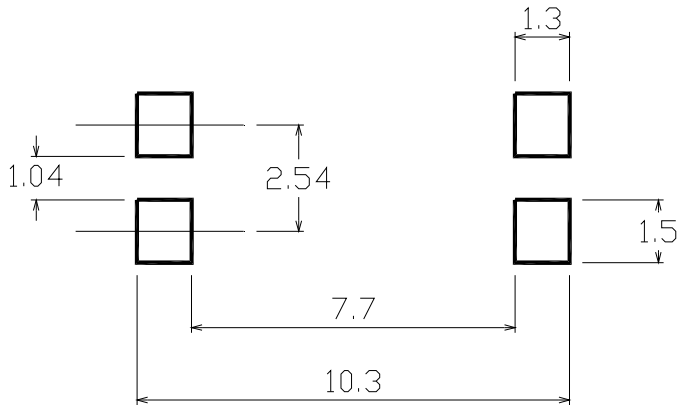
### 4 PIN DIP ZERO CROSS TRIAC DRIVER PHOTOCOUPLER

#### Option S Type



#### Option S1 Type



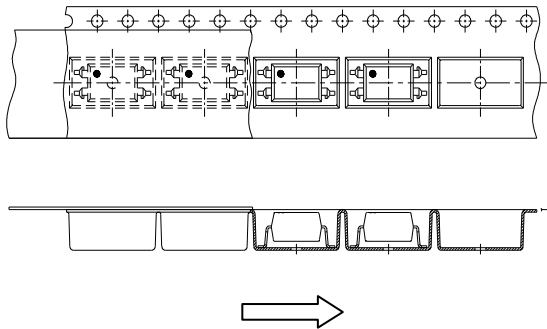
**4 PIN DIP ZERO CROSS TRIAC DRIVER  
PHOTOCOUPLER****Recommended pad layout for surface mount leadform****Device Marking****Notes**

- EL denotes Everlight
- T3083 denotes Device Number
- Y denotes 1 digit Year code
- WW denotes 2 digit Week code
- V denotes VDE option

## 4 PIN DIP ZERO CROSS TRIAC DRIVER PHOTOCOUPLER

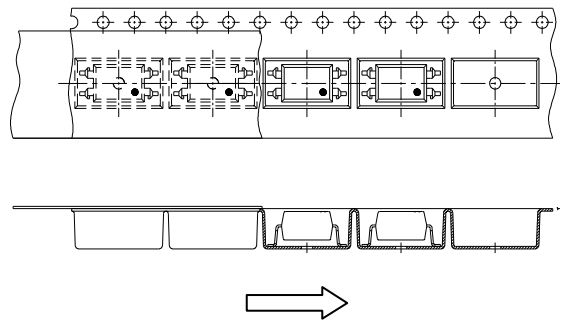
### Tape & Reel Packing Specifications

**Option TA**



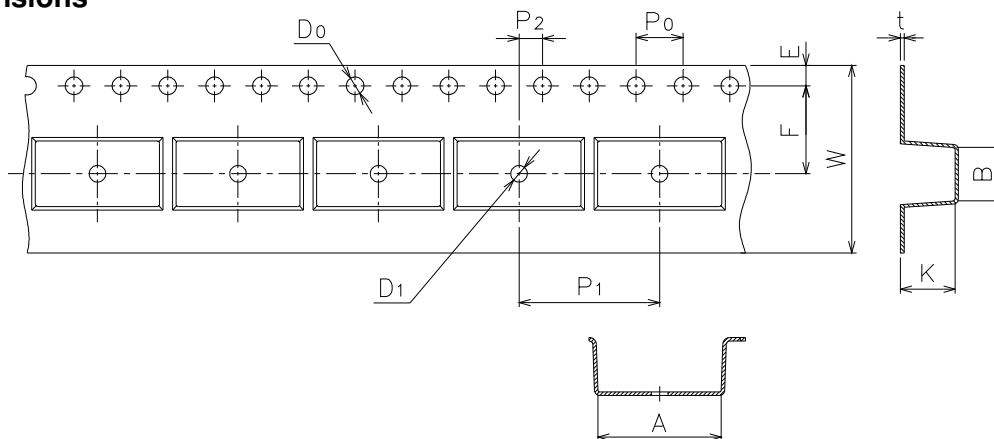
Direction of feed from reel

**Option TB**



Direction of feed from reel

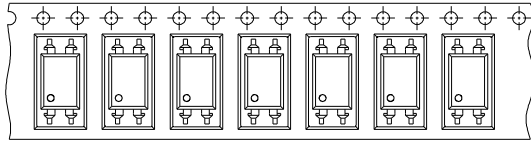
### Tape dimensions



Dimension No.	<b>A</b>	<b>B</b>	<b>Do</b>	<b>D1</b>	<b>E</b>	<b>F</b>
Dimension(mm)	10.4±0.1	4.55±0.1	1.5±0.1	1.5±0.05	1.75±0.1	7.5±0.1
Dimension No.	<b>Po</b>	<b>P1</b>	<b>P2</b>	<b>t</b>	<b>W</b>	<b>K</b>
Dimension(mm)	4.0±0.1	12.0±0.1	2.0±0.1	0.33±0.1	16.0+0.3/ -0.1	4.55±0.1

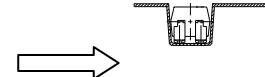
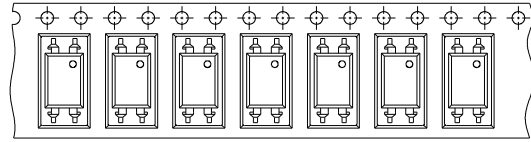
### 4 PIN DIP ZERO CROSS TRIAC DRIVER PHOTOCOUPLER

**Option TD**



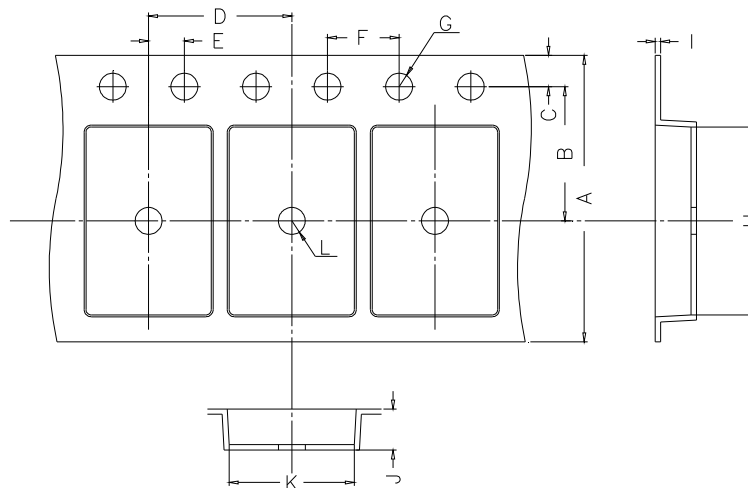
Direction of feed from reel

**Option TU**



Direction of feed from reel

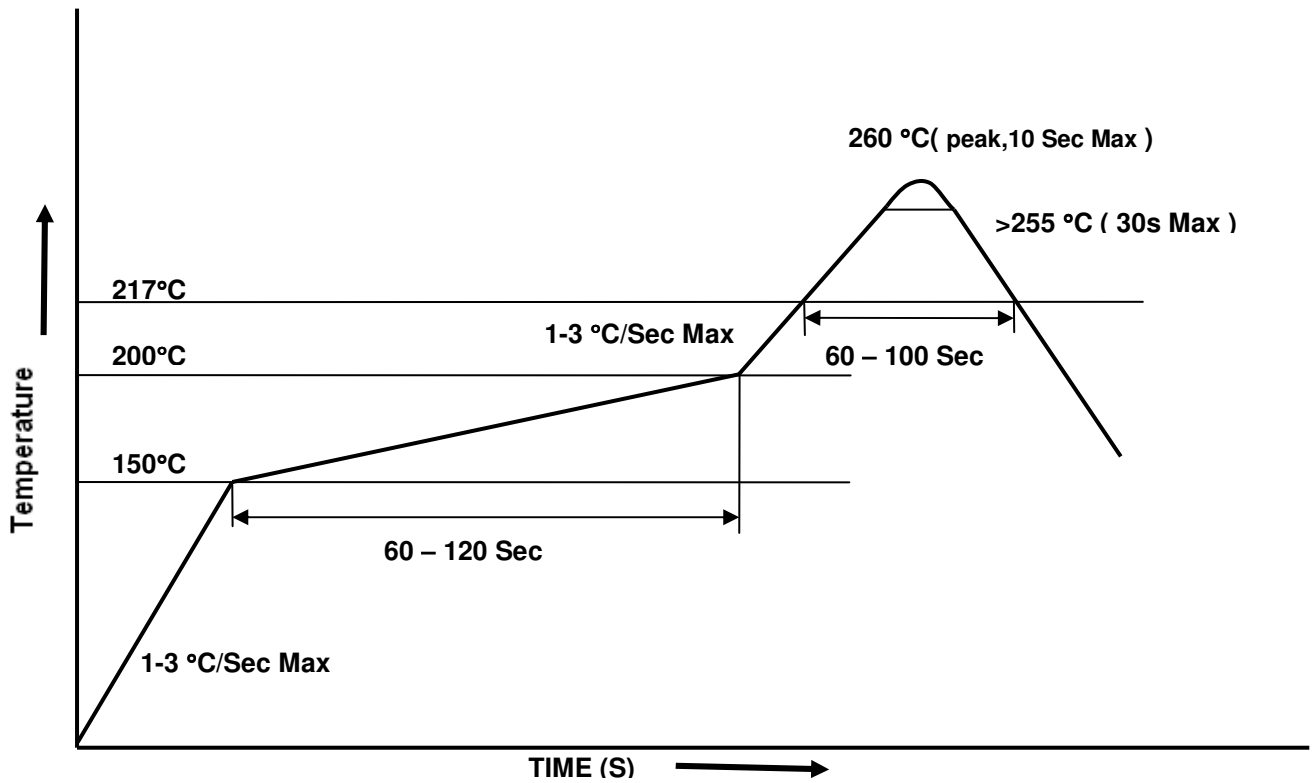
### Tape dimensions



Dimension No.	<b>A</b>	<b>B</b>	<b>C</b>	<b>D</b>	<b>E</b>	<b>F</b>
Dimension(mm)	16.00±0.3	7.5±0.1	1.75±0.1	8.0±0.1	2.0±0.1	4.0±0.1
Dimension No.	<b>G</b>	<b>H</b>	<b>I</b>	<b>J</b>	<b>K</b>	<b>L</b>
Dimension(mm)	1.5+0.1/-0	10.4±0.1	0.4±0.05	4.55±0.1	5.1±0.1	1.5±0.05

## 4 PIN DIP ZERO CROSS TRIAC DRIVER PHOTOCOUPLER

### Solder Reflow Temperature Profile



**4 PIN DIP ZERO CROSS TRIAC DRIVER  
PHOTOCOUPLER**

---

**DISCLAIMER**

1. Above specification may be changed without notice. EVERLIGHT will reserve authority on material change for above specification.
2. When using this product, please observe the absolute maximum ratings and the instructions for use outlined in these specification sheets. EVERLIGHT assumes no responsibility for any damage resulting from use of the product which does not comply with the absolute maximum ratings and the instructions included in these specification sheets.
3. These specification sheets include materials protected under copyright of EVERLIGHT. Reproduction in any form is prohibited without the specific consent of EVERLIGHT.