

4 PIN DIP ZERO CROSS TRIAC DRIVER PHOTOCOUPLER

Features:

- Peak breakdown voltage
 - 400V: ELT304X
 - 600V: ELT306X
 - 800V: ELT308X
- High isolation voltage between input and output (Viso=5000 V rms)
- Zero voltage crossing
- Pb free and RoHS compliant.
- UL approved (No.E214129)
- VDE approved (No.132249)
- SEMKO approved
- NEMKO approved
- DEMKO approved
- FIMKO approved
- CSA approved

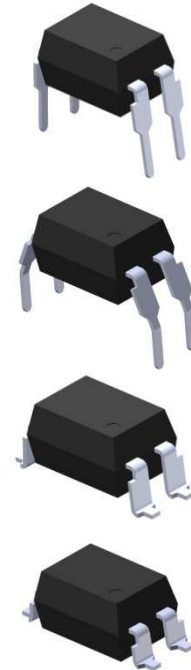

Description

The ELT304X, ELT306X and ELT308X series of devices each consist of a GaAs infrared emitting diode optically coupled to a monolithic silicon zero voltage crossing photo triac.

They are designed for use with a discrete power triac in the interface of logic systems to equipment powered from 110 to 380 VAC lines, such as solid-state relays, industrial controls, motors, solenoids and consumer appliances.

Schematic

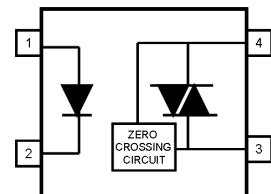

Pin Configuration

1. Anode
2. Cathode
3. Terminal
4. Terminal

Applications

- Solenoid/valve controls
- Light controls
- Static power switch
- AC motor drivers
- E.M. contactors
- Temperature controls
- AC Motor starters

**4 PIN DIP ZERO CROSS TRIAC DRIVER
PHOTOCOUPLER**

Absolute Maximum Ratings (T_a=25 °C)

| Parameter | | Symbol | Rating | Unit | |
|--------------------------|-----------------------------------|------------------|----------|-------|---|
| Input | Forward current | I _F | 60 | mA | |
| | Reverse voltage | V _R | 6 | V | |
| | Power dissipation | P _D | 100 | mW | |
| Output | Off-state Output Terminal Voltage | V _{DRM} | ELT304X | 400 | V |
| | | | ELT306X | 600 | |
| | | | ELT308X | 800 | |
| | Peak Repetitive Surge Current | I _{TSM} | 1 | A | |
| | Power dissipation | P _D | 300 | mW | |
| Isolation voltage *1 | | V _{iso} | 5000 | V rms | |
| Total power dissipation | | P _D | 330 | mW | |
| Operating temperature | | T _{opr} | -55~+100 | °C | |
| Storage temperature | | T _{stg} | -55~+125 | °C | |
| Soldering temperature *2 | | T _{sol} | 260 | °C | |

Notes

*1 AC for 1 minute, R.H.= 40 ~ 60% R.H. In this test, pins 1, 2 are shorted together, and pins 3, 4 are shorted together.

*2 For 10 seconds.

4 PIN DIP ZERO CROSS TRIAC DRIVER PHOTOCOUPLER

Electrical Characteristics ($T_a=25^\circ\text{C}$ unless specified otherwise)

Input

| Parameter | Symbol | Min. | Typ.* | Max. | Unit | Condition |
|-------------------------|--------|------|-------|------|---------------|---------------------|
| Forward voltage | V_F | - | - | 1.5 | V | $I_F = 30\text{mA}$ |
| Reverse Leakage current | I_R | - | - | 10 | μA | $V_R = 6\text{V}$ |

Output

| Parameter | Symbol | Min. | Typ.* | Max. | Unit | Condition |
|---|-------------------|-------|-------|------|------------------|--|
| Peak Blocking Current | ELT304X | - | - | 100 | nA | $V_{\text{DRM}} = \text{Rated } V_{\text{DRM}}$ $I_F = 0\text{mA}$ |
| | ELT306X/308X | | | 500 | | |
| Peak On-state Voltage | V_{TM} | - | - | 3 | V | $I_{\text{TM}}=100\text{mA peak, } I_F=\text{Rated } I_{\text{FT}}$ |
| Critical Rate of Rise of off-state Voltage | ELT304X /306X | dv/dt | 1000 | - | V/ μs | $V_{\text{PEAK}} = \text{Rated } V_{\text{DRM}}, I_F=0$ (Fig. 10) |
| | ELT308X | | 600 | - | | |
| Inhibit Voltage (MT1-MT2 voltage above which device will not trigger) | V_{INH} | - | - | 20 | V | $I_F = \text{Rated } I_{\text{FT}}$ |
| Leakage in Inhibited State | I_{DRM2} | - | - | 500 | μA | $I_F = \text{Rated } I_{\text{FT}}, V_{\text{DRM}} = \text{Rated } V_{\text{DRM}}, \text{off state}$ |

Transfer Characteristics

| Parameter | Symbol | Min. | Typ.* | Max. | Unit | Condition | |
|---------------------|-------------------------------|-----------------|-------|------|---------------|-----------|--------------------------|
| LED Trigger Current | ELT3042 ELT3062 ELT3082 | I_{FT} | - | - | 10 | mA | Main terminal Voltage=3V |
| | ELT3043 ELT3063 ELT3083 | | | | 5 | | |
| | ELT3044 ELT3064 ELT3084 | | | | 3 | | |
| Holding Current | I_H | - | 280 | - | μA | | |

* Typical values at $T_a = 25^\circ\text{C}$

4 PIN DIP ZERO CROSS TRIAC DRIVER PHOTOCOUPLER

Typical Performance Curves

Figure 1. Forward Current vs Forward Voltage

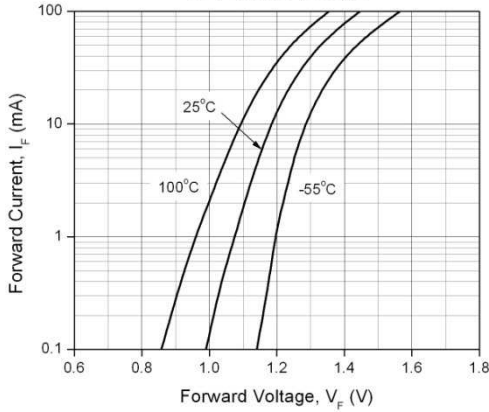

Figure 2. On-State Characteristics

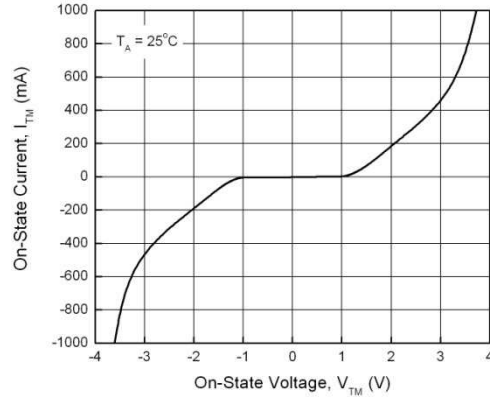

Figure 3. Holding Current vs. Ambient Temperature

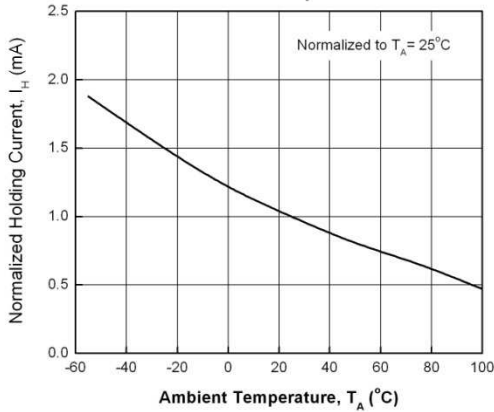

Figure 4. LED Current Required to Trigger vs. LED Pulse Width

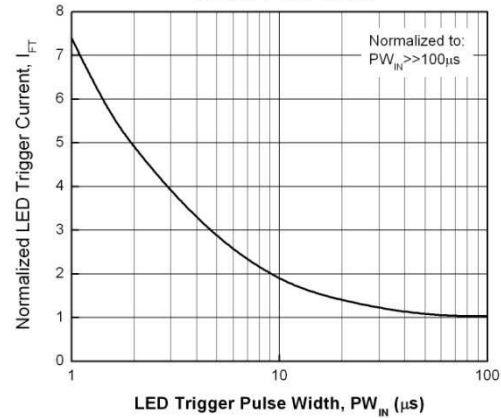

Figure 5. Leakage Current vs. Ambient Temperature

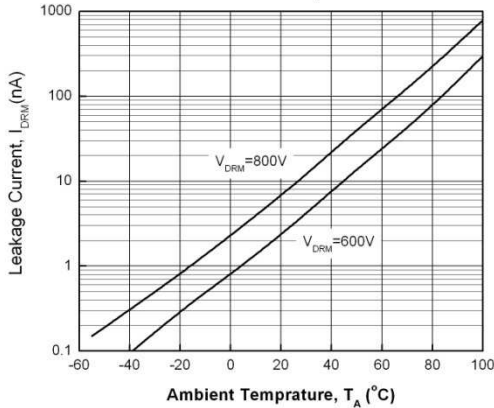
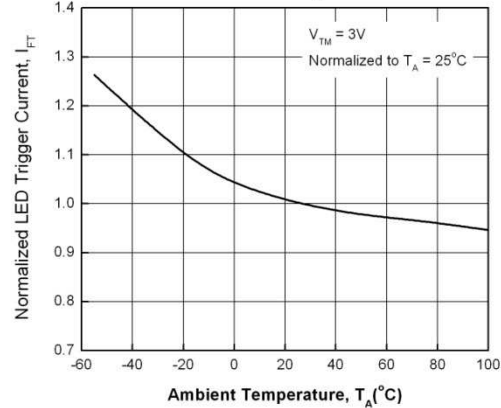

Figure 6. LED Trigger Current vs. Ambient Temperature



4 PIN DIP ZERO CROSS TRIAC DRIVER PHOTOCOUPLER

Figure 7. Off-State Output Terminal Voltage vs. Ambient Temperature

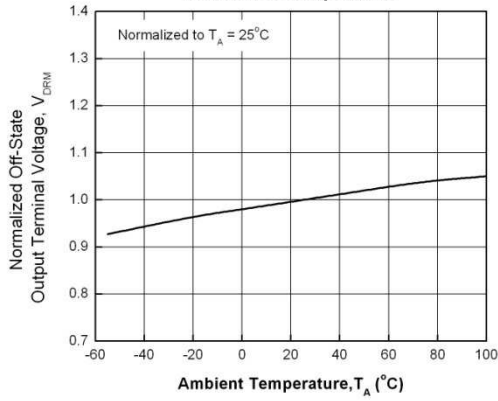

Figure 8. Leakage in Inhibit State vs. Ambient Temperature

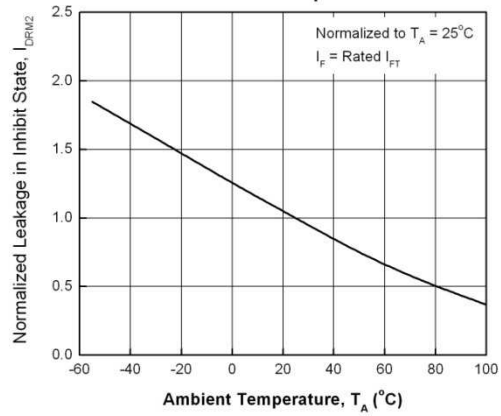
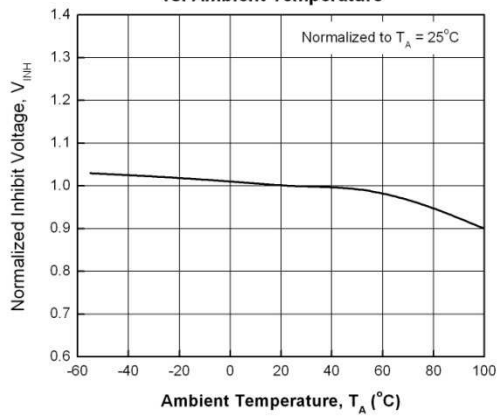
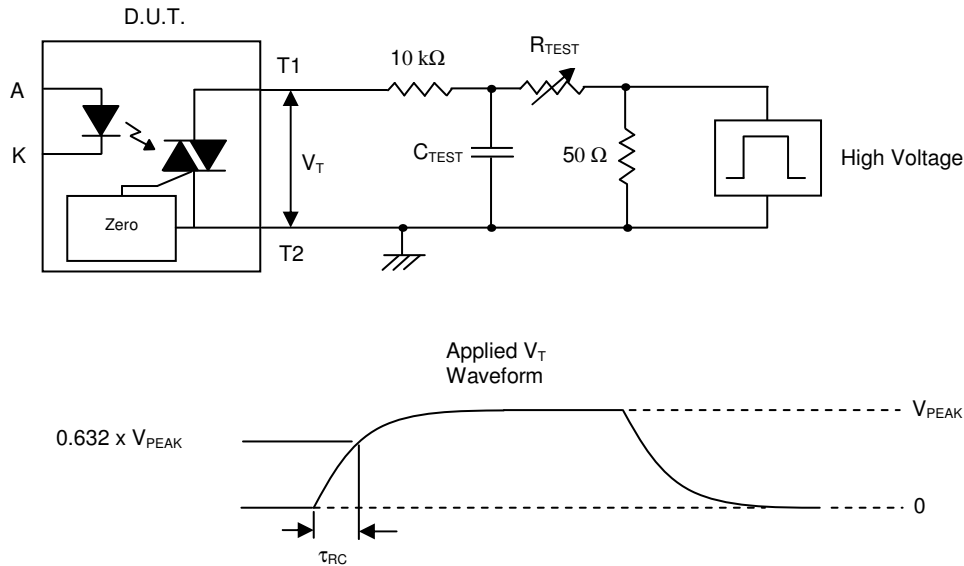

Figure 9. Inhibit Voltage vs. Ambient Temperature



**4 PIN DIP ZERO CROSS TRIAC DRIVER
 PHOTOCOUPLER**

Figure 10. Static dv/dt Test Circuit & Waveform



Measurement Method

The high voltage pulse is set to the required V_{PEAK} value and applied to the D.U.T. output side through the RC circuit above. LED current is not applied. The waveform V_T is monitored using a x100 scope probe. By varying R_{TEST} , the dv/dt (slope) is increased, until the D.U.T. is observed to trigger (waveform collapses). The dv/dt is then decreased until the D.U.T. stops triggering. At this point, τ_{RC} is recorded and the dv/dt calculated.

$$dv/dt = \frac{0.632 \times V_{PEAK}}{\tau_{RC}}$$

For example, $V_{PEAK} = 600V$ for ELT306X series. The dv/dt value is calculated as follows:

$$dv/dt = \frac{0.63 \times 600}{\tau_{RC}} = \frac{378}{\tau_{RC}}$$

**4 PIN DIP ZERO CROSS TRIAC DRIVER
PHOTOCOUPLER****Order Information****Part Number****ELT304X(Y)(Z)-V**or **ELT306X(Y)(Z)-V**or **ELT308X(Y)(Z)-V**Note

X = Part No. (2, 3 or 4)

Y = Lead form option (S, S1, M or none)

Z = Tape and reel option (TA, TB or none).

V = VDE safety approved option

| Option | Description | Packing quantity |
|---------|---|---------------------|
| None | Standard DIP-4 | 100 units per tube |
| M | Wide lead bend (0.4 inch spacing) | 100 units per tube |
| S (TA) | Surface mount lead form + TA tape & reel option | 1000 units per reel |
| S (TB) | Surface mount lead form + TB tape & reel option | 1000 units per reel |
| S1 (TA) | Surface mount lead form (low profile) + TA tape & reel option | 1000 units per reel |
| S1 (TB) | Surface mount lead form (low profile) + TB tape & reel option | 1000 units per reel |
| S (TU) | Surface mount lead form + TU tape & reel option | 1500 units per reel |
| S (TD) | Surface mount lead form + TD tape & reel option | 1500 units per reel |
| S1 (TU) | Surface mount lead form (low profile) + TU tape & reel option | 1500 units per reel |
| S1 (TD) | Surface mount lead form (low profile) + TD tape & reel option | 1500 units per reel |

**4 PIN DIP ZERO CROSS TRIAC DRIVER
PHOTOCOUPLER****Package Drawings**

(Dimensions in mm)

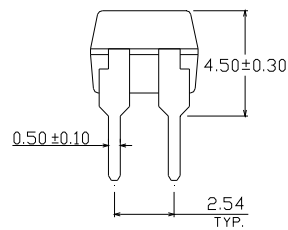
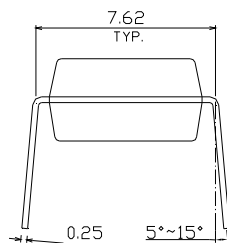
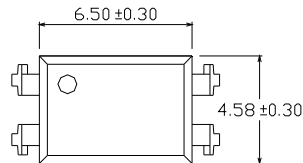
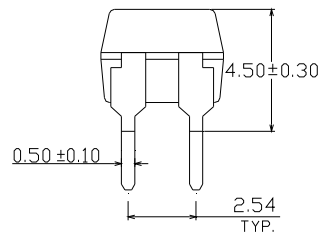
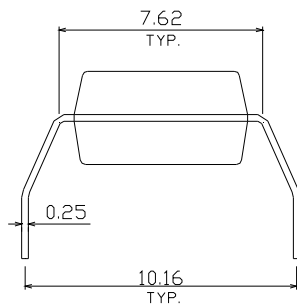
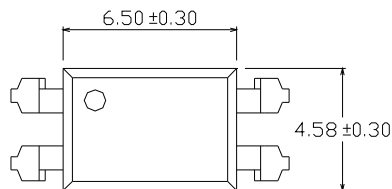
Standard DIP Type**Option M Type**

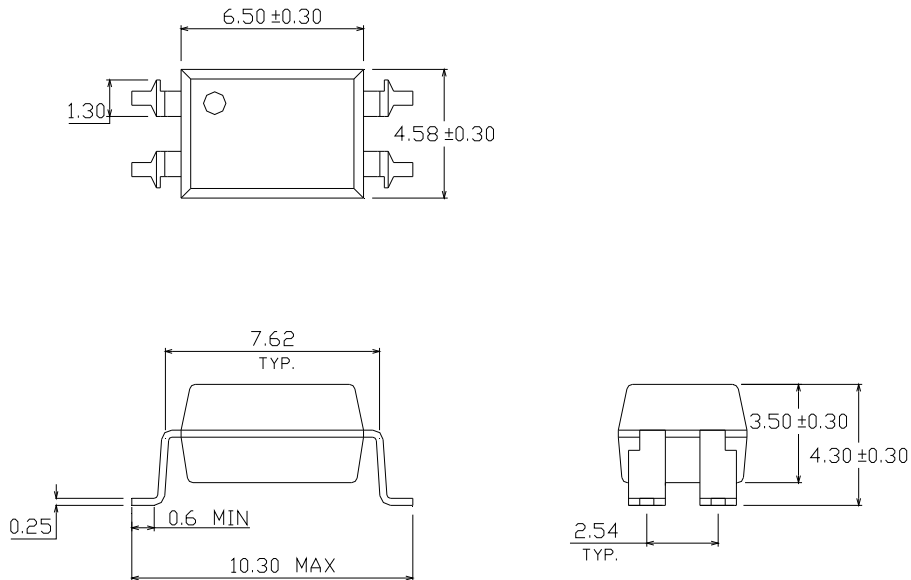
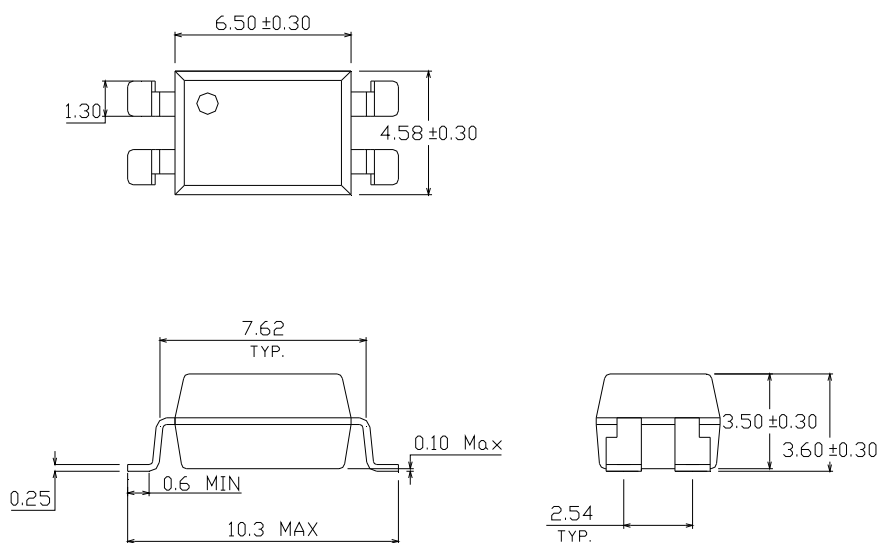
**4 PIN DIP ZERO CROSS TRIAC DRIVER
PHOTOCOUPLER****Option S Type****Option S1 Type**

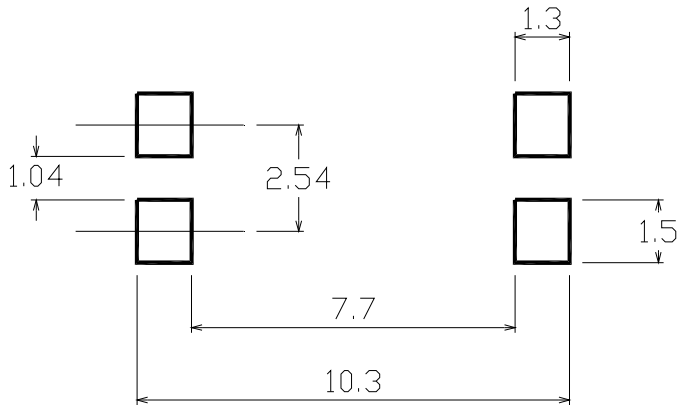
**4 PIN DIP ZERO CROSS TRIAC DRIVER
PHOTOCOUPLER****Recommended pad layout for surface mount leadform****Device Marking****Notes**

- EL denotes Everlight
- T3083 denotes Device Number
- Y denotes 1 digit Year code
- WW denotes 2 digit Week code
- V denotes VDE option

4 PIN DIP ZERO CROSS TRIAC DRIVER PHOTOCOUPLER

Tape & Reel Packing Specifications

Option TA

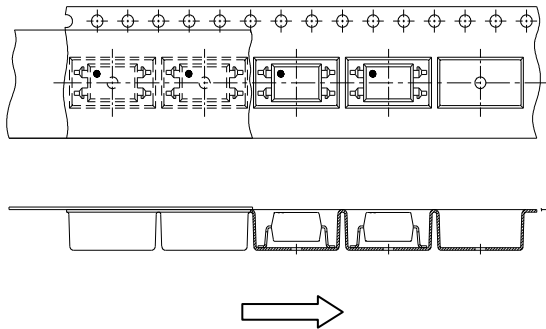

Direction of feed from reel

Option TB

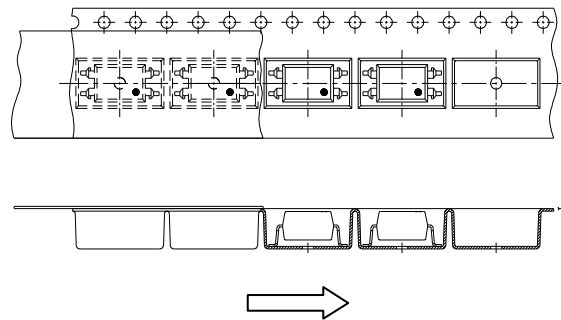

Direction of feed from reel

Tape dimensions

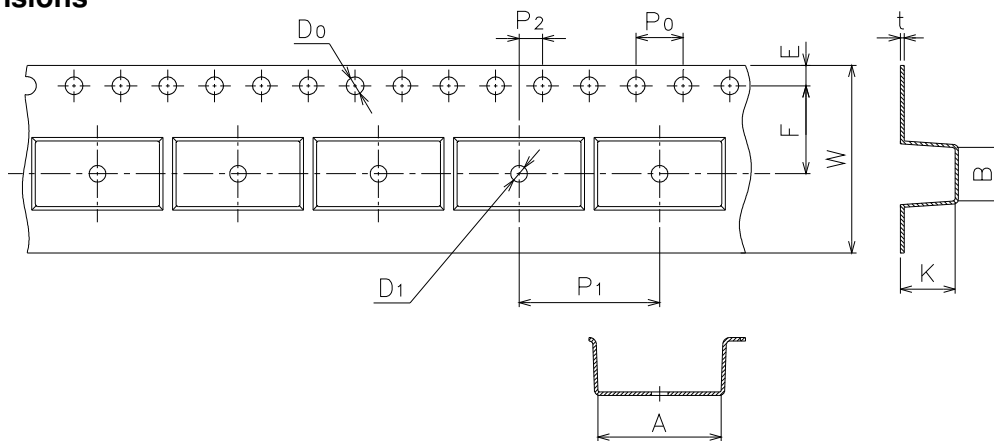

| | | | | | | |
|---------------|-----------|-----------|-----------|-----------|-------------------|----------|
| Dimension No. | A | B | Do | D1 | E | F |
| Dimension(mm) | 10.4±0.1 | 4.55±0.1 | 1.5±0.1 | 1.5±0.05 | 1.75±0.1 | 7.5±0.1 |
| Dimension No. | Po | P1 | P2 | t | W | K |
| Dimension(mm) | 4.0±0.1 | 12.0±0.1 | 2.0±0.1 | 0.33±0.1 | 16.0+0.3/ -0.1 | 4.55±0.1 |

4 PIN DIP ZERO CROSS TRIAC DRIVER PHOTOCOUPLER

Option TD

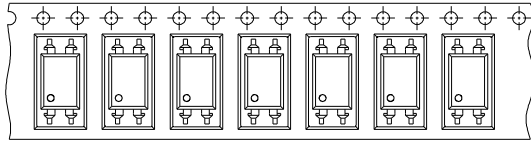

Direction of feed from reel

Option TU

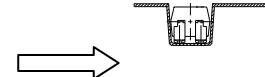
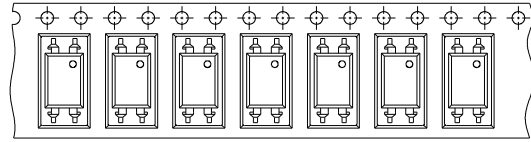

Direction of feed from reel

Tape dimensions

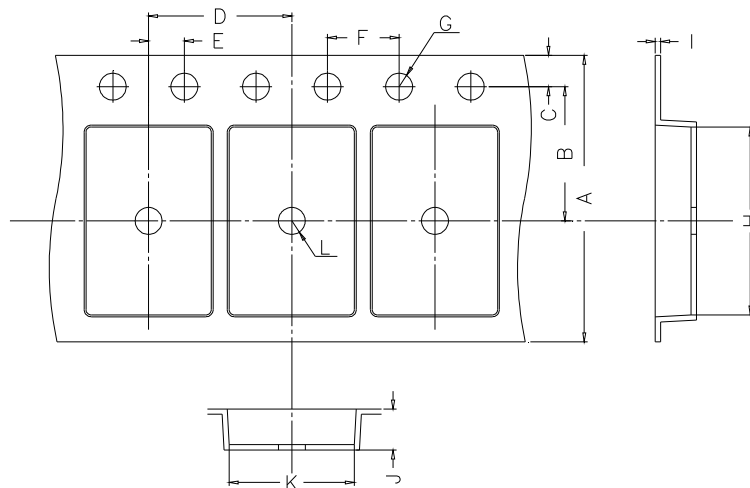

| | | | | | | |
|---------------|------------|----------|----------|----------|----------|----------|
| Dimension No. | A | B | C | D | E | F |
| Dimension(mm) | 16.00±0.3 | 7.5±0.1 | 1.75±0.1 | 8.0±0.1 | 2.0±0.1 | 4.0±0.1 |
| Dimension No. | G | H | I | J | K | L |
| Dimension(mm) | 1.5+0.1/-0 | 10.4±0.1 | 0.4±0.05 | 4.55±0.1 | 5.1±0.1 | 1.5±0.05 |

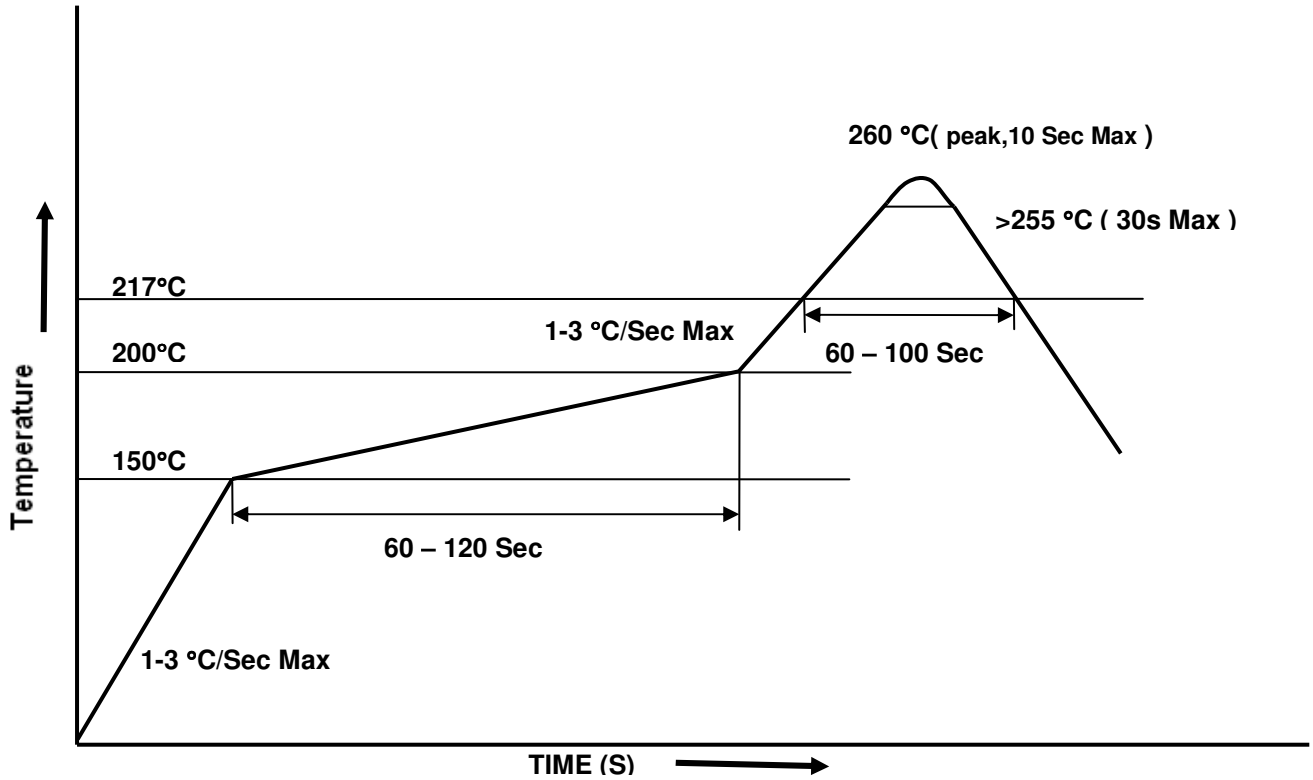
Solder Reflow Temperature Profile

**4 PIN DIP ZERO CROSS TRIAC DRIVER
PHOTOCOUPLER**

DISCLAIMER

1. Above specification may be changed without notice. EVERLIGHT will reserve authority on material change for above specification.
2. When using this product, please observe the absolute maximum ratings and the instructions for use outlined in these specification sheets. EVERLIGHT assumes no responsibility for any damage resulting from use of the product which does not comply with the absolute maximum ratings and the instructions included in these specification sheets.
3. These specification sheets include materials protected under copyright of EVERLIGHT. Reproduction in any form is prohibited without the specific consent of EVERLIGHT.