

## Schottky Rectifier, 2 x 15 A

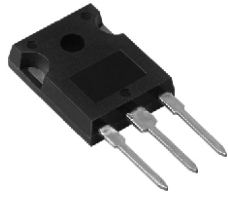

TO-247AC

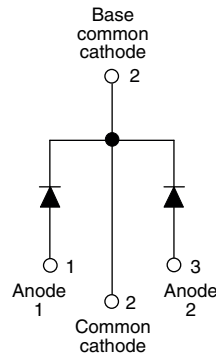

### FEATURES

- 175 °C  $T_J$  operation
- Low forward voltage drop
- High frequency operation
- High purity, high temperature epoxy encapsulation for enhanced mechanical strength and moisture resistance
- Guard ring for enhanced ruggedness and long term reliability
- Compliant to RoHS Directive 2002/95/EC
- Designed and qualified according to JEDEC-JESD47
- Halogen-free according to IEC 61249-2-21 definition (-N3 only)



PRODUCT SUMMARY	
Package	TO-247AC
$I_{F(AV)}$	2 x 15 A
$V_R$	80 V, 90 V, 100 V
$V_F$ at $I_F$	0.67 V
$I_{RM}$ max.	7 mA at 125 °C
$T_J$ max.	175 °C
Diode variation	Common cathode
$E_{AS}$	7.5 mJ

### DESCRIPTION

The VS-30CPQ...G... center tap Schottky rectifier has been optimized for low reverse leakage at high temperature. The proprietary barrier technology allows for reliable operation up to 175 °C junction temperature. Typical applications are in switching power supplies, converters, freewheeling diodes, and reverse battery protection.

MAJOR RATINGS AND CHARACTERISTICS			
SYMBOL	CHARACTERISTICS	VALUES	UNITS
$I_{F(AV)}$	Rectangular waveform	30	A
$V_{RRM}$		80 to 100	V
$I_{FSM}$	$t_p = 5 \mu s$ sine	920	A
$V_F$	15 Apk, $T_J = 125 \text{ °C}$ (per leg)	0.67	V
$T_J$		- 55 to 175	°C

VOLTAGE RATINGS								
PARAMETER	SYMBOL	VS-30CPQ080GPbF	VS-30CPQ080G-N3	VS-30CPQ090GPbF	VS-30CPQ090G-N3	VS-30CPQ100GPbF	VS-30CPQ100G-N3	UNITS
Maximum DC reverse voltage	$V_R$	80	80	90	90	100	100	V
Maximum working peak reverse voltage	$V_{RWM}$							

ABSOLUTE MAXIMUM RATINGS					
PARAMETER	SYMBOL	TEST CONDITIONS	VALUES	UNITS	
Maximum average forward current See fig. 5	$I_{F(AV)}$	50 % duty cycle at $T_C = 140 \text{ °C}$ , rectangular waveform	30	A	
Maximum peak one cycle non-repetitive surge current per leg See fig. 7	$I_{FSM}$	5 $\mu s$ sine or 3 $\mu s$ rect. pulse	Following any rated load condition and with rated $V_{RRM}$ applied		920
		10 ms sine or 6 ms rect. pulse			240
Non-repetitive avalanche energy per leg	$E_{AS}$	$T_J = 25 \text{ °C}$ , $I_{AS} = 0.50 \text{ A}$ , $L = 60 \text{ mH}$	7.50	mJ	
Repetitive avalanche current per leg	$I_{AR}$	Current decaying linearly to zero in 1 $\mu s$ Frequency limited by $T_J$ maximum $V_A = 1.5 \times V_R$ typical	0.50	A	



ELECTRICAL SPECIFICATIONS					
PARAMETER	SYMBOL	TEST CONDITIONS		VALUES	UNITS
Maximum forward voltage drop per leg See fig. 1	$V_{FM}^{(1)}$	15 A	$T_J = 25\text{ }^\circ\text{C}$	0.86	V
		30 A		1.05	
		15 A	$T_J = 125\text{ }^\circ\text{C}$	0.67	
		30 A		0.81	
Maximum reverse leakage current per leg See fig. 2	$I_{RM}^{(1)}$	$T_J = 25\text{ }^\circ\text{C}$	$V_R = \text{Rated } V_R$	0.28	mA
		$T_J = 125\text{ }^\circ\text{C}$		7	
Maximum junction capacitance per leg	$C_T$	$V_R = 5 V_{DC}$ (test signal range 100 kHz to 1 MHz) $25\text{ }^\circ\text{C}$		500	pF
Typical series inductance per leg	$L_S$	Measured lead to lead 5 mm from package body		7.5	nH
Maximum voltage rate of change	dV/dt	Rated $V_R$		10 000	V/ $\mu$ s

**Note**

 (1) Pulse width < 300  $\mu$ s, duty cycle < 2 %

THERMAL - MECHANICAL SPECIFICATIONS					
PARAMETER	SYMBOL	TEST CONDITIONS		VALUES	UNITS
Maximum junction and storage temperature range	$T_J, T_{Stg}$			- 55 to 175	$^\circ\text{C}$
Maximum thermal resistance, junction to case per leg	$R_{thJC}$	DC operation See fig. 4		2.20	$^\circ\text{C/W}$
Maximum thermal resistance, junction to case per package		DC operation		1.10	
Typical thermal resistance, case to heatsink	$R_{thCS}$	Mounting surface, smooth and greased		0.24	
Approximate weight				6	g
				0.21	oz.
Mounting torque	minimum <hr/> maximum		Non-lubricated threads	6 (5)	kgf · cm (lbf · in)
				12 (10)	
Marking device			Case style TO-247AC (JEDEC)	30CPQ080G	
				30CPQ090G	
				30CPQ100G	

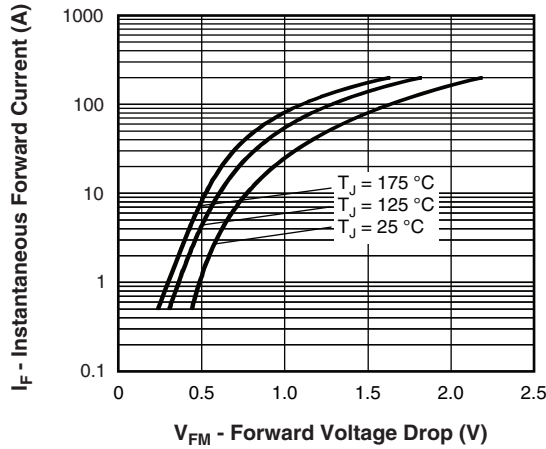

Fig. 1 - Maximum Forward Voltage Drop Characteristics (Per Leg)

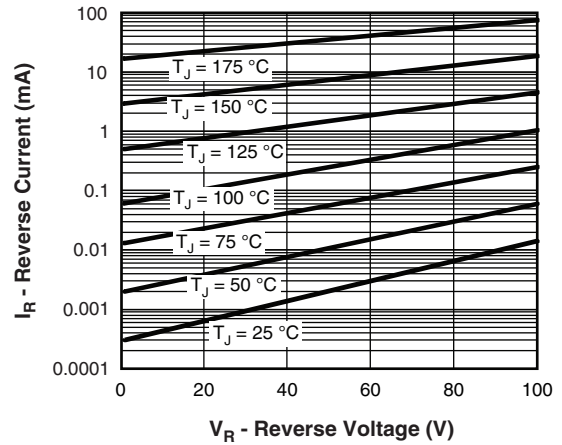

Fig. 2 - Typical Values of Reverse Current vs. Reverse Voltage (Per Leg)

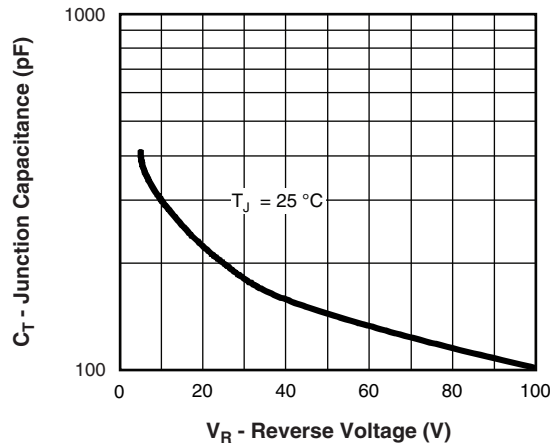

Fig. 3 - Typical Junction Capacitance vs. Reverse Voltage (Per Leg)

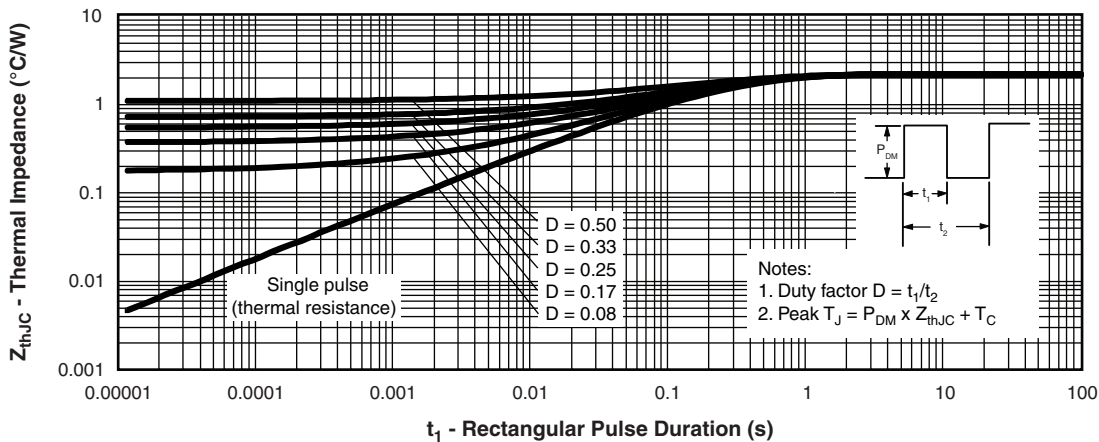

Fig. 4 - Maximum Thermal Impedance  $Z_{thJC}$  Characteristics (Per Leg)

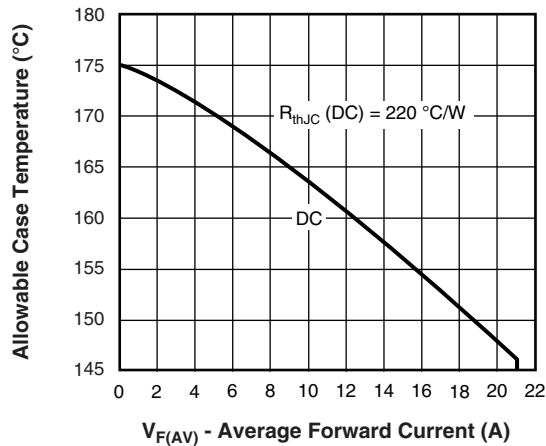

Fig. 5 - Maximum Allowable Case Temperature vs. Average Forward Current (Per Leg)

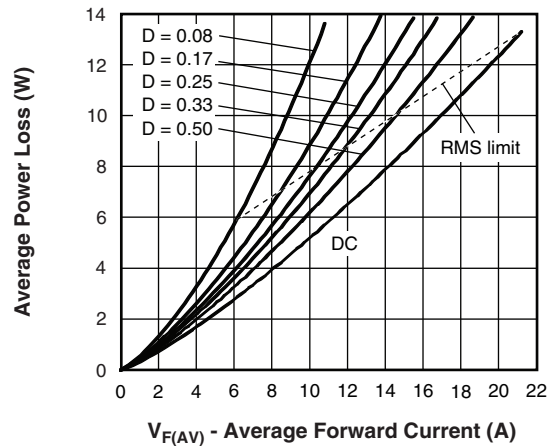

Fig. 6 - Forward Power Loss Characteristics (Per Leg)

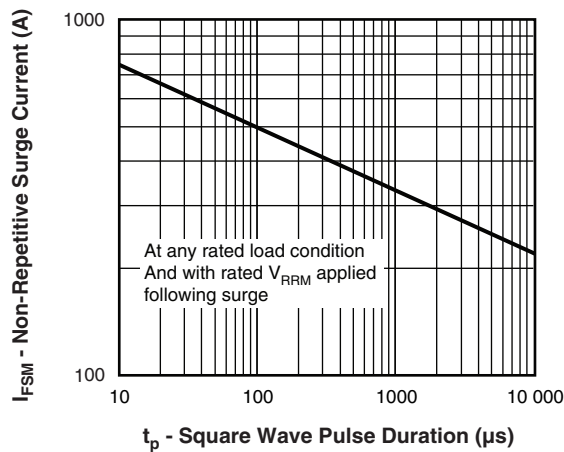

Fig. 7 - Maximum Non-Repetitive Surge Current (Per Leg)

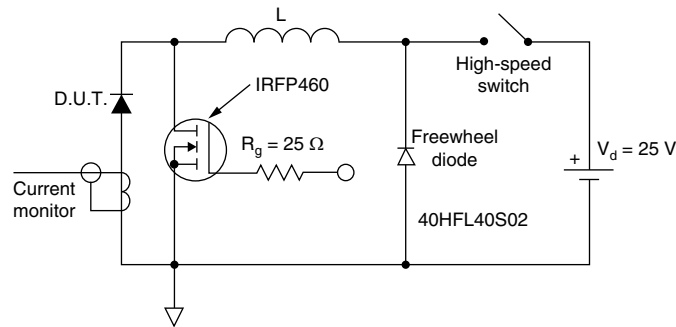
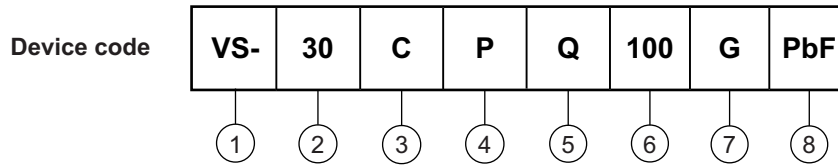

Fig. 8 - Unclamped Inductive Test Circuit



## ORDERING INFORMATION TABLE



- 1** - Vishay Semiconductors product
- 2** - Current rating
- 3** - Circuit configuration:  
C = Common cathode
- 4** - Package:  
P = TO-247
- 5** - Schottky "Q" series
- 6** - Voltage code
- 7** - G = Schottky generation
- 8** - Environmental digit
  - PbF = Lead (Pb)-free and RoHS compliant
  - -N3 = Halogen-free, RoHS compliant, and totally lead (Pb)-free

080 = 80 V
090 = 90 V
100 = 100 V

ORDERING INFORMATION (Example)			
PREFERRED P/N	QUANTITY PER T/R	MINIMUM ORDER QUANTITY	PACKAGING DESCRIPTION
VS-30CPQ080GPbF	25	500	Antistatic plastic tube
VS-30CPQ080G-N3	25	500	Antistatic plastic tube
VS-30CPQ090GPbF	25	500	Antistatic plastic tube
VS-30CPQ090G-N3	25	500	Antistatic plastic tube
VS-30CPQ100GPbF	25	500	Antistatic plastic tube
VS-30CPQ100G-N3	25	500	Antistatic plastic tube

LINKS TO RELATED DOCUMENTS	
Dimensions	<a href="http://www.vishay.com/doc?95223">www.vishay.com/doc?95223</a>
Part marking information	TO-247AC PbF <a href="http://www.vishay.com/doc?95226">www.vishay.com/doc?95226</a>
	TO-247AC -N3 <a href="http://www.vishay.com/doc?95007">www.vishay.com/doc?95007</a>
SPIICE model	<a href="http://www.vishay.com/doc?95469">www.vishay.com/doc?95469</a>



### DIMENSIONS in millimeters and inches

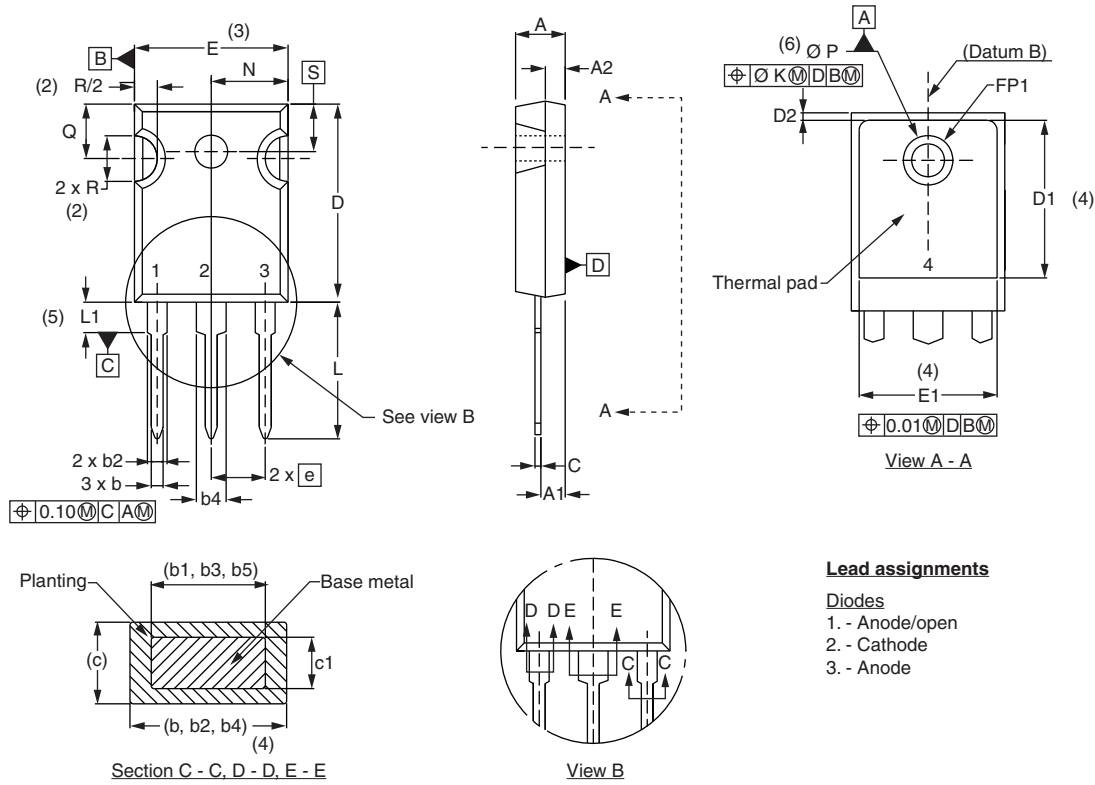

#### Lead assignments

- Diodes  
 1. - Anode/open  
 2. - Cathode  
 3. - Anode

SYMBOL	MILLIMETERS		INCHES		NOTES	SYMBOL	MILLIMETERS		INCHES		NOTES
	MIN.	MAX.	MIN.	MAX.			MIN.	MAX.	MIN.	MAX.	
A	4.65	5.31	0.183	0.209		D2	0.51	1.30	0.020	0.051	
A1	2.21	2.59	0.087	0.102		E	15.29	15.87	0.602	0.625	3
A2	1.50	2.49	0.059	0.098		E1	13.72	-	0.540	-	
b	0.99	1.40	0.039	0.055		e	5.46 BSC		0.215 BSC		
b1	0.99	1.35	0.039	0.053		FK	2.54		0.010		
b2	1.65	2.39	0.065	0.094		L	14.20	16.10	0.559	0.634	
b3	1.65	2.37	0.065	0.094		L1	3.71	4.29	0.146	0.169	
b4	2.59	3.43	0.102	0.135		N	7.62 BSC		0.3		
b5	2.59	3.38	0.102	0.133		ØP	3.56	3.66	0.14	0.144	
c	0.38	0.86	0.015	0.034		ØP1	-	6.98	-	0.275	
c1	0.38	0.76	0.015	0.030		Q	5.31	5.69	0.209	0.224	
D	19.71	20.70	0.776	0.815	3	R	4.52	5.49	1.78	0.216	
D1	13.08	-	0.515	-	4	S	5.51 BSC		0.217 BSC		

#### Notes

- (1) Dimensioning and tolerancing per ASME Y14.5M-1994
- (2) Contour of slot optional
- (3) Dimension D and E do not include mold flash. Mold flash shall not exceed 0.127 mm (0.005") per side. These dimensions are measured at the outermost extremes of the plastic body
- (4) Thermal pad contour optional with dimensions D1 and E1
- (5) Lead finish uncontrolled in L1
- (6) Ø P to have a maximum draft angle of 1.5 to the top of the part with a maximum hole diameter of 3.91 mm (0.154")
- (7) Outline conforms to JEDEC outline TO-247 with exception of dimension c



## Disclaimer

ALL PRODUCT, PRODUCT SPECIFICATIONS AND DATA ARE SUBJECT TO CHANGE WITHOUT NOTICE TO IMPROVE RELIABILITY, FUNCTION OR DESIGN OR OTHERWISE.

Vishay Intertechnology, Inc., its affiliates, agents, and employees, and all persons acting on its or their behalf (collectively, "Vishay"), disclaim any and all liability for any errors, inaccuracies or incompleteness contained in any datasheet or in any other disclosure relating to any product.

Vishay makes no warranty, representation or guarantee regarding the suitability of the products for any particular purpose or the continuing production of any product. To the maximum extent permitted by applicable law, Vishay disclaims (i) any and all liability arising out of the application or use of any product, (ii) any and all liability, including without limitation special, consequential or incidental damages, and (iii) any and all implied warranties, including warranties of fitness for particular purpose, non-infringement and merchantability.

Statements regarding the suitability of products for certain types of applications are based on Vishay's knowledge of typical requirements that are often placed on Vishay products in generic applications. Such statements are not binding statements about the suitability of products for a particular application. It is the customer's responsibility to validate that a particular product with the properties described in the product specification is suitable for use in a particular application. Parameters provided in datasheets and/or specifications may vary in different applications and performance may vary over time. All operating parameters, including typical parameters, must be validated for each customer application by the customer's technical experts. Product specifications do not expand or otherwise modify Vishay's terms and conditions of purchase, including but not limited to the warranty expressed therein.

Except as expressly indicated in writing, Vishay products are not designed for use in medical, life-saving, or life-sustaining applications or for any other application in which the failure of the Vishay product could result in personal injury or death. Customers using or selling Vishay products not expressly indicated for use in such applications do so at their own risk and agree to fully indemnify and hold Vishay and its distributors harmless from and against any and all claims, liabilities, expenses and damages arising or resulting in connection with such use or sale, including attorneys fees, even if such claim alleges that Vishay or its distributor was negligent regarding the design or manufacture of the part. Please contact authorized Vishay personnel to obtain written terms and conditions regarding products designed for such applications.

No license, express or implied, by estoppel or otherwise, to any intellectual property rights is granted by this document or by any conduct of Vishay. Product names and markings noted herein may be trademarks of their respective owners.

## Material Category Policy

**Vishay Intertechnology, Inc. hereby certifies that all its products that are identified as RoHS-Compliant fulfill the definitions and restrictions defined under Directive 2011/65/EU of The European Parliament and of the Council of June 8, 2011 on the restriction of the use of certain hazardous substances in electrical and electronic equipment (EEE) - recast, unless otherwise specified as non-compliant.**

**Please note that some Vishay documentation may still make reference to RoHS Directive 2002/95/EC. We confirm that all the products identified as being compliant to Directive 2002/95/EC conform to Directive 2011/65/EU.**