

N-Channel 60 V (D-S) MOSFET

PRODUCT SUMMARY			
$V_{DS(min.)}$ (V)	$R_{DS(on)}$ (Ω)	$V_{GS(th)}$ (V)	I_D (mA)
60	1.25 at $V_{GS} = 10$ V	1 to 2.5	330

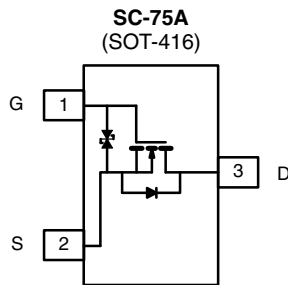

Marking Code: E

Ordering Information: Si1022R-T1-GE3 (Lead (Pb)-free and Halogen-free)

FEATURES

- Halogen-free According to IEC 61249-2-21 Definition
- TrenchFET[®] Power MOSFETs
- Low On-Resistance: 1.25 Ω
- Low Threshold: 2.5 V
- Low Input Capacitance: 30 pF
- Fast Switching Speed: 25 ns
- Low Input and Output Leakage
- Miniature Package
- ESD Protected: 2000 V
- Compliant to RoHS Directive 2002/95/EC



RoHS
COMPLIANT
HALOGEN
FREE

APPLICATIONS

- Drivers: Relays, Solenoids, Lamps, Hammers, Displays, Memories, Transistors, etc.
- Battery Operated Systems
- Solid State Relays

BENEFITS

- Low Offset Voltage
- Low-Voltage Operation
- High-Speed Circuits
- Low Error Voltage
- Small Board Area

ABSOLUTE MAXIMUM RATINGS ($T_A = 25$ °C, unless otherwise noted)			
Parameter	Symbol	Limit	Unit
Drain-Source Voltage	V_{DS}	60	V
Gate-Source Voltage	V_{GS}	± 20	
Continuous Drain Current ^a	I_D	$T_A = 25$ °C	330
		$T_A = 85$ °C	240
Pulsed Drain Current ^a	I_{DM}	650	mA
Power Dissipation ^a	P_D	$T_A = 25$ °C	250
		$T_A = 85$ °C	130
Thermal Resistance, Maximum Junction-to-Ambient ^a	R_{thJA}	500	°C/W
Operating Junction and Storage Temperature Range	T_J, T_{stg}	- 55 to 150	°C

Notes:

a. Surface mounted on FR4 board, power applied for $t \leq 10$ s.

SPECIFICATIONS ($T_J = 25\text{ }^\circ\text{C}$, unless otherwise noted)						
Parameter	Symbol	Test Conditions	Min.	Typ.	Max.	Unit
Static						
Drain-Source Breakdown Voltage	V_{DS}	$V_{GS} = 0\text{ V}$, $I_D = 10\text{ }\mu\text{A}$	60			V
Gate-Threshold Voltage	$V_{GS(th)}$	$V_{DS} = V_{GS}$, $I_D = 0.25\text{ mA}$	1		2.5	
Gate-Body Leakage	I_{GSS}	$V_{DS} = 0\text{ V}$, $V_{GS} = \pm 10\text{ V}$			± 150	nA
		$T_J = 85\text{ }^\circ\text{C}$			± 500	
Zero Gate Voltage Drain Current	I_{DSS}	$V_{DS} = 0\text{ V}$, $V_{GS} = \pm 5\text{ V}$			± 20	
		$V_{DS} = 50\text{ V}$, $V_{GS} = 0\text{ V}$			10	
On-State Drain Current ^a	$I_{D(on)}$	$V_{DS} = 10\text{ V}$, $V_{GS} = 4.5\text{ V}$	500			mA
		$V_{DS} = 7.5\text{ V}$, $V_{GS} = 10\text{ V}$	800			
Drain-Source On-State Resistance ^a	$R_{DS(on)}$	$V_{GS} = 4.5\text{ V}$, $I_D = 200\text{ mA}$			3.0	Ω
		$T_J = 125\text{ }^\circ\text{C}$			5.0	
		$V_{GS} = 10\text{ V}$, $I_D = 500\text{ mA}$			1.25	
Forward Transconductance ^a	g_{fs}	$V_{DS} = 10\text{ V}$, $I_D = 200\text{ mA}$	100			mS
Diode Forward Voltage ^a	V_{SD}	$V_{GS} = 0\text{ V}$, $I_S = 200\text{ mA}$			1.3	V
Dynamic^b						
Input Capacitance	C_{iss}	$V_{DS} = 25\text{ V}$, $V_{GS} = 0\text{ V}$, $f = 1\text{ MHz}$		30		pF
Output Capacitance	C_{oss}			6		
Reverse Transfer Capacitance	C_{rss}			2.5		
Gate Charge	Q_g	$V_{DS} = 10\text{ V}$, $I_D = 250\text{ mA}$, $V_{GS} = 4.5\text{ V}$			0.6	nC
Switching^{b, c}						
Turn-On Time	$t_{(on)}$	$V_{DD} = 30\text{ V}$, $R_L = 150\text{ }\Omega$, $I_D = 200\text{ mA}$, $V_{GEN} = 10\text{ V}$, $R_g = 10\text{ }\Omega$			25	ns
Turn-Off Time	$t_{(off)}$				35	

Notes:

- Pulse test; pulse width $\leq 300\text{ }\mu\text{s}$, duty cycle $\leq 2\%$.
- For DESIGN AID ONLY, not subject to production testing.
- Switching time is essentially independent of operating temperature.

Stresses beyond those listed under "Absolute Maximum Ratings" may cause permanent damage to the device. These are stress ratings only, and functional operation of the device at these or any other conditions beyond those indicated in the operational sections of the specifications is not implied. Exposure to absolute maximum rating conditions for extended periods may affect device reliability.

TYPICAL CHARACTERISTICS ($T_A = 25\text{ }^\circ\text{C}$, unless otherwise noted)

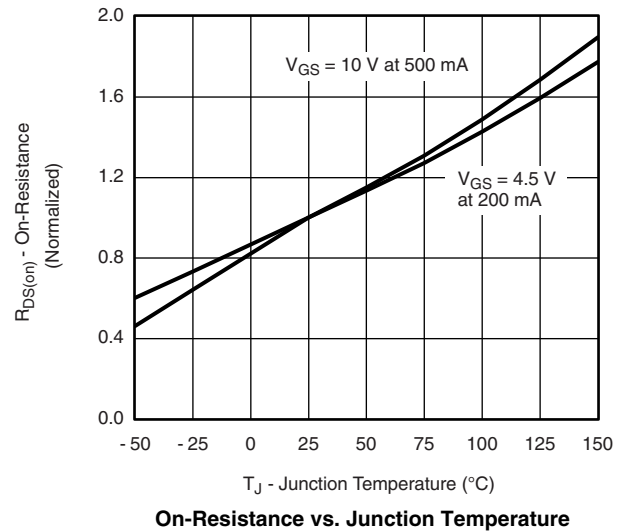
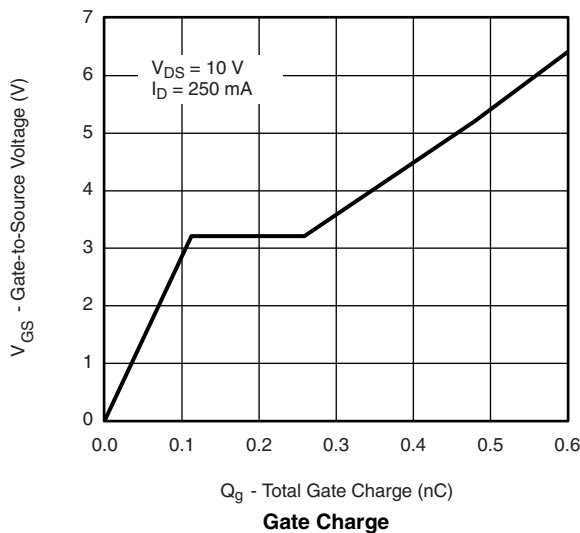
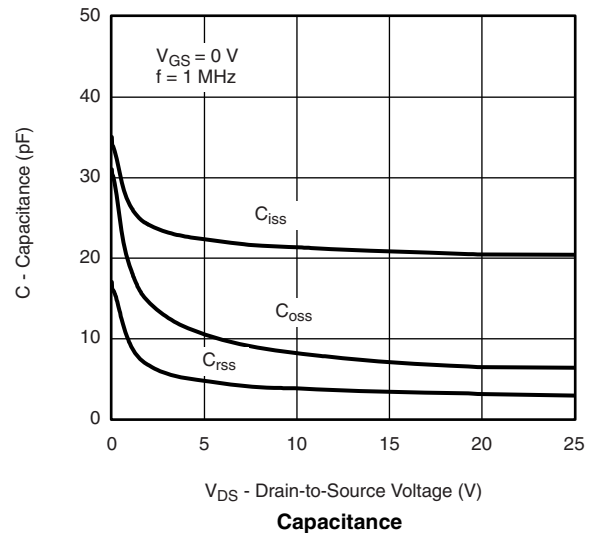
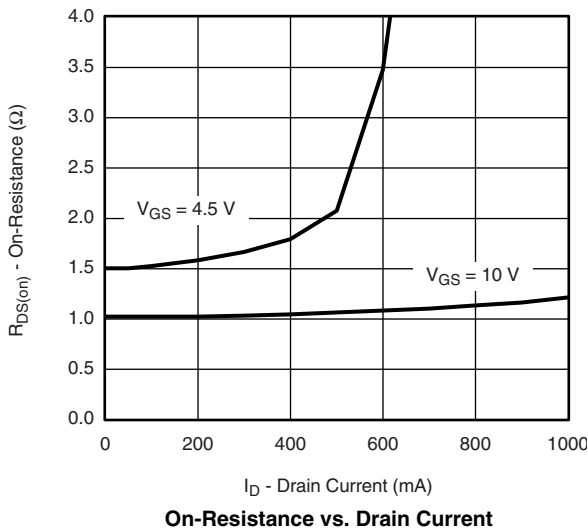
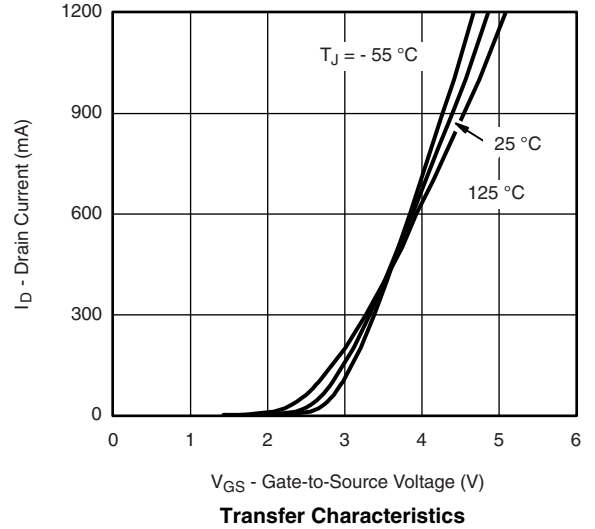
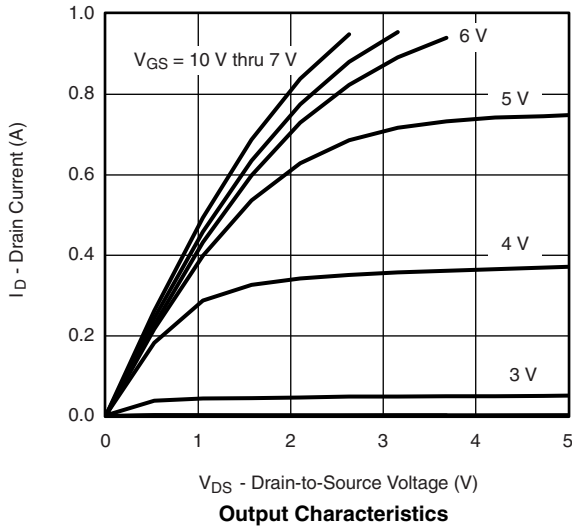

TYPICAL CHARACTERISTICS ($T_A = 25\text{ }^\circ\text{C}$, unless otherwise noted)

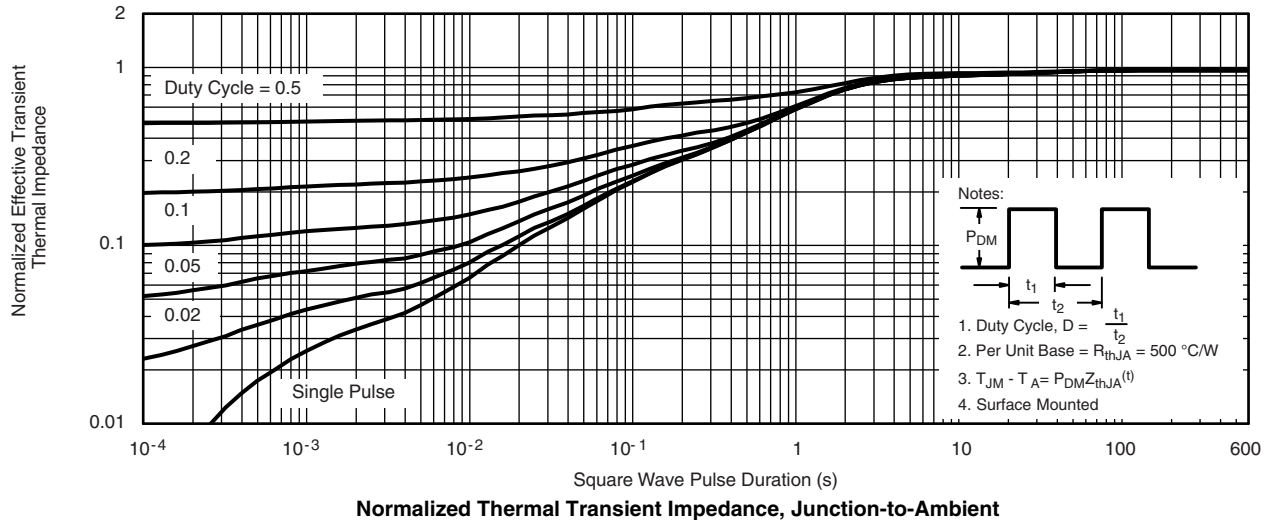
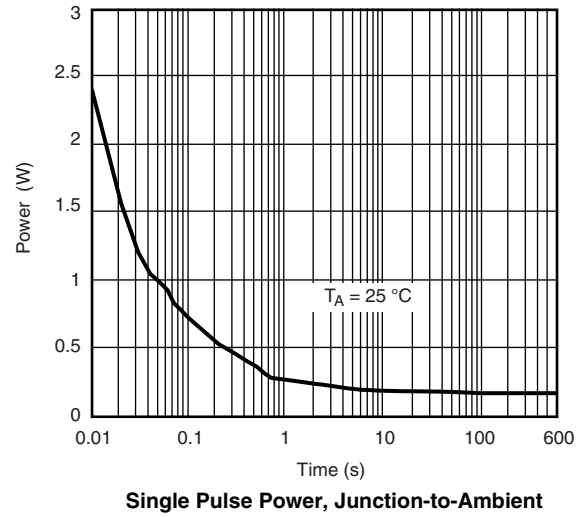
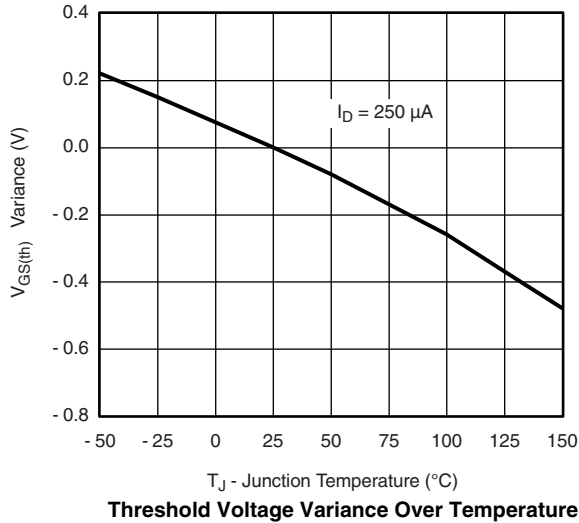
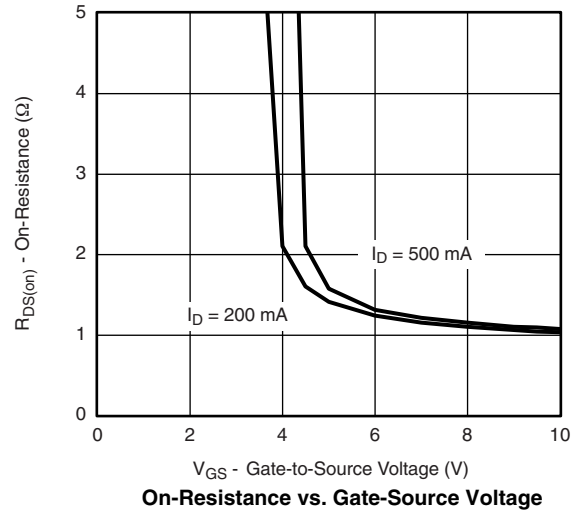
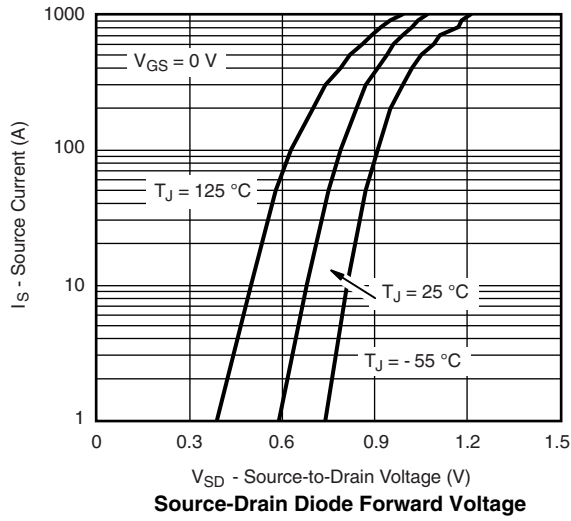

Vishay Siliconix maintains worldwide manufacturing capability. Products may be manufactured at one of several qualified locations. Reliability data for Silicon Technology and Package Reliability represent a composite of all qualified locations. For related documents such as package/tape drawings, part marking, and reliability data, see www.vishay.com/ppq?71331.



SC-75A: 3-LEADS

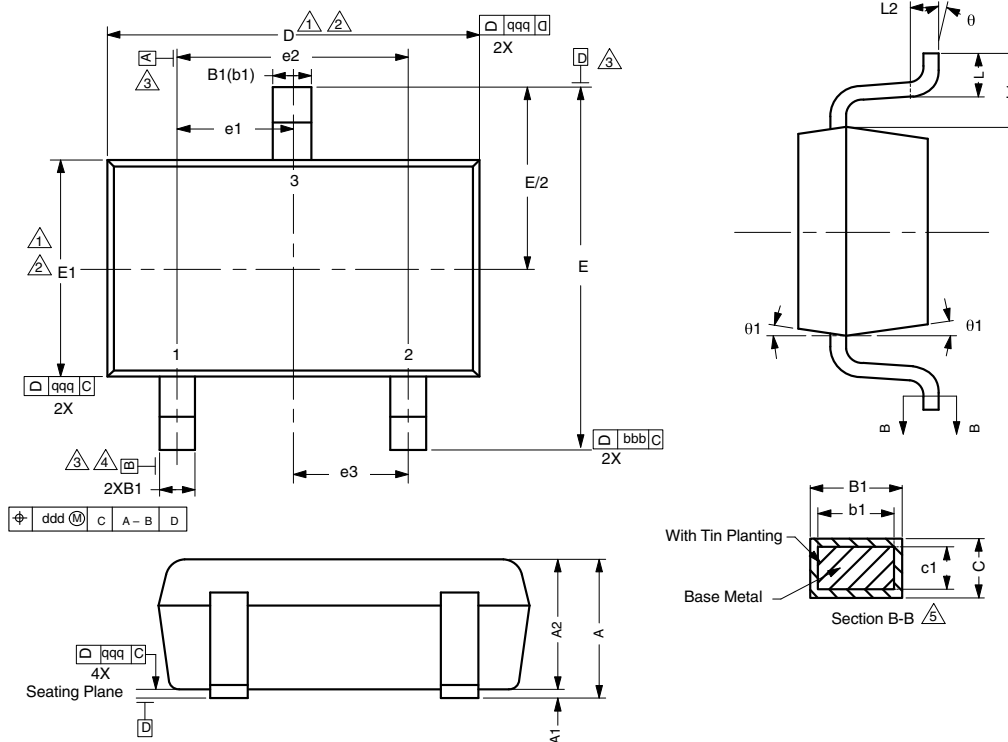

Notes

Dimensions in millimeters will govern.

1. Dimension D does not include mold flash, protrusions or gate burrs. Mold flash protrusions or gate burrs shall not exceed 0.10 mm per end. Dimension E1 does not include Interlead flash or protrusion. Interlead flash or protrusion shall not exceed 0.10 mm per side.
2. Dimensions D and E1 are determined at the outmost extremes of the plastic body exclusive of mold flash, tie bar burrs, gate burrs and interlead flash, but including any mismatch between the top and bottom of the plastic body.
3. Datums A, B and D to be determined 0.10 mm from the lead tip.
4. Terminal positions are shown for reference only.
5. These dimensions apply to the flat section of the lead between 0.08 mm and 0.15 mm from the lead tip.

DIMENSIONS	TOLERANCES
aaa	0.10
bbb	0.10
ccc	0.10
ddd	0.10

DIM.	MILLIMETERS			NOTE
	MIN.	NOM.	MAX.	
A	-	-	0.80	
A ₁	0.00	-	0.10	
A ₂	0.65	0.70	0.80	
B ₁	0.19	-	0.24	5
b ₁	0.17	-	0.21	
c	0.13	-	0.15	5
c ₁	0.10	-	0.12	5
D	1.48	1.575	1.68	1, 2
E	1.50	1.60	1.70	
E ₁	0.66	0.76	0.86	1, 2
e ₁	0.50 BSC			
e ₂	1.00 BSC			
e ₃	0.50 BSC			
L	0.15	0.205	0.30	
L ₁	0.40 REF			
L ₂	0.15 BSC			
θ	0°	-	8°	
θ ₁	4°	-	10°	

ECN: E11-2210-Rev. D, 08-Aug-11
DWG: 5868

RECOMMENDED MINIMUM PADS FOR SC-75A: 3-Lead

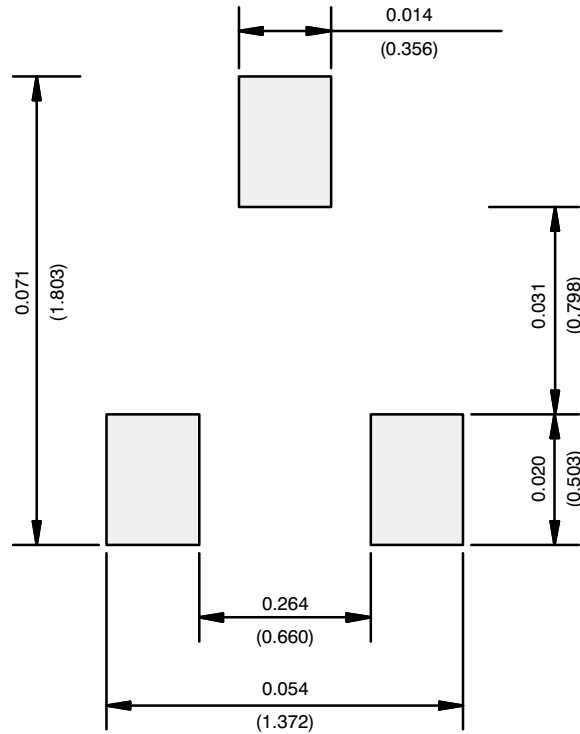

Recommended Minimum Pads
Dimensions in Inches/(mm)

[Return to Index](#)



Disclaimer

ALL PRODUCT, PRODUCT SPECIFICATIONS AND DATA ARE SUBJECT TO CHANGE WITHOUT NOTICE TO IMPROVE RELIABILITY, FUNCTION OR DESIGN OR OTHERWISE.

Vishay Intertechnology, Inc., its affiliates, agents, and employees, and all persons acting on its or their behalf (collectively, "Vishay"), disclaim any and all liability for any errors, inaccuracies or incompleteness contained in any datasheet or in any other disclosure relating to any product.

Vishay makes no warranty, representation or guarantee regarding the suitability of the products for any particular purpose or the continuing production of any product. To the maximum extent permitted by applicable law, Vishay disclaims (i) any and all liability arising out of the application or use of any product, (ii) any and all liability, including without limitation special, consequential or incidental damages, and (iii) any and all implied warranties, including warranties of fitness for particular purpose, non-infringement and merchantability.

Statements regarding the suitability of products for certain types of applications are based on Vishay's knowledge of typical requirements that are often placed on Vishay products in generic applications. Such statements are not binding statements about the suitability of products for a particular application. It is the customer's responsibility to validate that a particular product with the properties described in the product specification is suitable for use in a particular application. Parameters provided in datasheets and/or specifications may vary in different applications and performance may vary over time. All operating parameters, including typical parameters, must be validated for each customer application by the customer's technical experts. Product specifications do not expand or otherwise modify Vishay's terms and conditions of purchase, including but not limited to the warranty expressed therein.

Except as expressly indicated in writing, Vishay products are not designed for use in medical, life-saving, or life-sustaining applications or for any other application in which the failure of the Vishay product could result in personal injury or death. Customers using or selling Vishay products not expressly indicated for use in such applications do so at their own risk and agree to fully indemnify and hold Vishay and its distributors harmless from and against any and all claims, liabilities, expenses and damages arising or resulting in connection with such use or sale, including attorneys fees, even if such claim alleges that Vishay or its distributor was negligent regarding the design or manufacture of the part. Please contact authorized Vishay personnel to obtain written terms and conditions regarding products designed for such applications.

No license, express or implied, by estoppel or otherwise, to any intellectual property rights is granted by this document or by any conduct of Vishay. Product names and markings noted herein may be trademarks of their respective owners.

Material Category Policy

Vishay Intertechnology, Inc. hereby certifies that all its products that are identified as RoHS-Compliant fulfill the definitions and restrictions defined under Directive 2011/65/EU of The European Parliament and of the Council of June 8, 2011 on the restriction of the use of certain hazardous substances in electrical and electronic equipment (EEE) - recast, unless otherwise specified as non-compliant.

Please note that some Vishay documentation may still make reference to RoHS Directive 2002/95/EC. We confirm that all the products identified as being compliant to Directive 2002/95/EC conform to Directive 2011/65/EU.