

# EQ-733L

Shipped in bulk(500pcs/Pack)

EQ-733L is composed of an InAs Quantum Well Hall Element and a signal processing IC chip in a package  
 Notice:It is requested to read and accept "IMPORTANT NOTICE" written on the back of the front cover of this catalogue.

## ●Features

- Analog output which proportional to the magnetic field strength and pole.
- Magnetic sensitivity 20mV/mT(typ.)
- Supply voltage from 3.0V to 5.5V at single power supply
- Operating temperature range -40°C~100°C
- Ratio-metric analog output
- 3pin surface mount plastic package
- Quick response 1 μs  
(when the rise-up time of magnetic field is rather than 1 μs)
- Low output noise voltage 2mVp-p



## ●Operational Characteristics

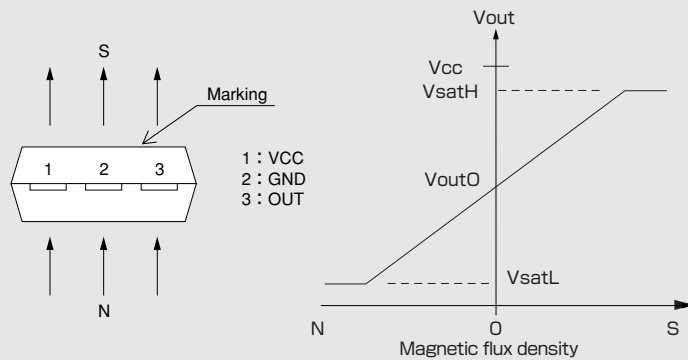

## ●Pin and functions

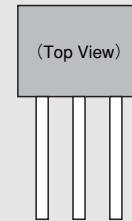

| Pin No. | Pin name | Function     |
|---------|----------|--------------|
| 1       | VCC      | Power supply |
| 2       | GND      | Ground       |
| 3       | OUT      | Output       |

## ●Functional Block Diagram

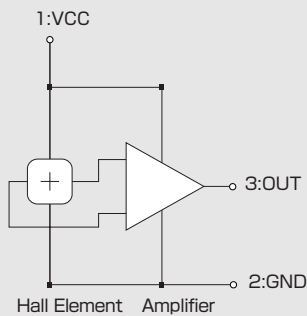

## ●Application Circuit

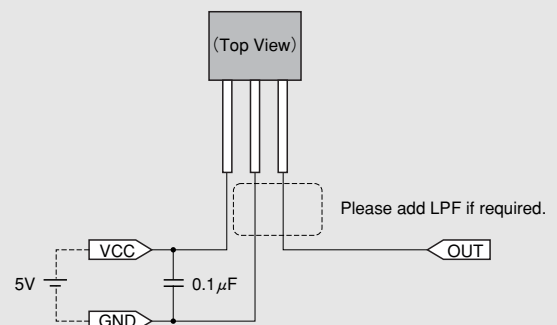

## ●Absolute Maximum Ratings (Ta=25°C)

| parameter                     | symbol           | specification | unit |
|-------------------------------|------------------|---------------|------|
| Supply voltage                | V <sub>CC</sub>  | -0.3 ~ 6      | V    |
| output current                | I <sub>out</sub> | ±1.2(*)       | mA   |
| operating ambient temperature | T <sub>opr</sub> | -40 ~ 100     | °C   |
| Storage ambient temperature   | T <sub>stg</sub> | -40 ~ 125     | °C   |

(\*) V<sub>CC</sub>=5V

## ●Recommend operating conditions

| parameter      | symbol           | min  | typ | max  | unit |
|----------------|------------------|------|-----|------|------|
| Supply voltage | V <sub>CC</sub>  | 3.0  | 5.0 | 5.5  | V    |
| output current | I <sub>OUT</sub> | -1.0 |     | 1.0  | mA   |
| output load    | C <sub>L</sub>   |      |     | 1000 | pF   |

●Electric characteristics (TA=25°C, VCC=5V)

| Parameter   | Symbol            | Conditions   | min                  | Typ | Max             | Unit  |
|---|-------------------|--|----------------------|-----|-----------------|-------|
| Current consumption                                     | I <sub>CC</sub>   | B=0mT with no load   |                      | 9   | 12              | mA    |
| Output saturation voltage at High Level <sup>(*1)</sup> | V <sub>SATH</sub> | I <sub>OUT</sub> =-1mA   | V <sub>CC</sub> -0.3 |     | V <sub>CC</sub> | V     |
| Output saturation voltage at Low Level <sup>(*1)</sup>  | V <sub>SATL</sub> | I <sub>OUT</sub> =1mA  | 0                    |     | 0.3             | V     |
| Bandwidth <sup>(*2)</sup>                               | f <sub>T</sub>    | -3dB C <sub>L</sub> =1000pF  |                      | 260 |                 | kHz   |
| Response time <sup>(*2)</sup>                           | t <sub>RES</sub>  | Rise time : 10% of Input MFD to 90% of output voltage.<br>Fall time: 90% of Input MFD to 10% of output voltage.<br>(under input/output MFD step is 1 to 2μs)<br>C <sub>L</sub> =1000pF |                      | 1   |                 | μs    |
| Output rise time <sup>(*2)</sup>                        | t <sub>RISE</sub> | 10% to 90% of output voltage under input/output MFD step is 1 to 2μs.<br>C <sub>L</sub> =1000pF  |                      | 2   |                 | μs    |
| Output fall time <sup>(*2)</sup>                        | t <sub>FALL</sub> | 90% to 10% of output voltage under input/output MFD step is 1 to 2μs<br>C <sub>L</sub> =1000pF   |                      |     |                 |       |
| Output delay time <sup>(*2)</sup>                       | t <sub>REAC</sub> | Rise time : 10% of Input MFD to 10% of output voltage.<br>Fall time: 90% of Input MFD to 90% of output voltage.<br>(under input/output MFD step is 1 to 2μs)<br>C <sub>L</sub> =1000pF |                      | 0.3 |                 | μs    |
| Output noise voltage <sup>(*2)</sup>                    | V <sub>Np-p</sub> |  |                      | 2   |                 | mVp-p |

(\*1&2) Design target at 25°C

※ 1mT = 10Gauss

●Magnetic characteristics (TA=25°C, VCC=5V)

| Parameter                   | Symbol            | Conditions  | min  | Typ | Max  | Unit  |
|-----------------------------|-------------------|---|------|-----|------|-------|
| Sensitivity <sup>(*3)</sup> | V <sub>h</sub>    | B=0, ±41mT with no load   | 17   | 20  | 23   | mV/mT |
| Quiescent voltage           | V <sub>OUT0</sub> | B=0mT   | 2.45 | 2.5 | 2.55 | V     |
| Linearity <sup>(*4)</sup>   | ρ                 | B=0mT (I <sub>OUT</sub> =0mA)<br>B=±50mT (I <sub>OUT</sub> =±1mA) | -0.5 |     | 0.5  | %F.S. |

(\*3) See Characteristic Definitions section

※ 1mT = 10Gauss

(\*4) See Characteristic Definitions section

●Ratio-metric characteristics (TA=25°C)

| Parameter  | Symbol              | Conditions              | min | Typ | Max | Unit |
|--|---------------------|-------------------------|-----|-----|-----|------|
| Error in Ratiometric of Magnetic sensitivity <sup>(*5)</sup> | V <sub>h-R</sub>    | B=0, ±41mT with no load | -3  |     | 3   | %    |
| Error in Ratiometric of Quiescent voltage <sup>(*5)</sup>    | V <sub>OUT0-R</sub> | B=0mT                   | -3  |     | 3   | %    |

(\*5) See Characteristic Definitions section

※ 1mT = 10Gauss

●Characteristic Definitions

①Magnetic sensitivity V<sub>h</sub> (mV/mT)

Magnetic sensitivity is defined as the slope of the straight line obtained from three points, Quiescent voltage V<sub>OUT0</sub>, V<sub>OUT</sub> (+B), V<sub>OUT</sub> (-B) (B is described in measurement condition), by the least square approximation.

②Linearity ρ (%F.S.)

Linearity is defined as the ratio of a error voltage against FULLSCALE. Where error voltage is calculate as the difference from the straight line obtained from three points, Quiescent voltage V<sub>OUT0</sub>, V<sub>OUT</sub> (+B), V<sub>OUT</sub> (-B) (B and Output current are described in measurement condition shown below), by the least square approximation.

〈Condition〉: 0mT applied, I<sub>OUT</sub> = 0mA

+BmT applied : I<sub>OUT</sub>=+1.0mA (Draw out from output)

-BmT applied : I<sub>OUT</sub>=-1.0mA (Draw in to output)

$$\rho = \frac{V_{out}(B) - \{V_h \times B + V_{int}\}}{V_{out}(+B) - V_{out}(-B)} \times 100$$

Where FULLSCALE(F.S.) is defied as V<sub>OUT</sub> (+B), V<sub>OUT</sub> (-B), V<sub>int</sub> is y-intercepts of the line obtained in the Definition of Magnetic sensitivity.

③Error in Ratiometric of Magnetic sensitivity and Error in Ratiometric of quiescent voltage

Error in ratiometric is defined as the ratio of the variation of sensitivity and quiescent voltage at 3V and 5V as following equations..

$$V_{h-R} = \frac{V_h(V_{CC}=3V)}{V_h(V_{CC}=5V)} \frac{3}{5} \times 100 \quad V_{OUT0-R} = \frac{V_{OUT0}(V_{CC}=3V)}{V_{OUT0}(V_{CC}=5V)} \frac{3}{5} \times 100$$

④Response time t<sub>RES</sub> (μs)

Response time is defined as the time from the 90% reach point of input magnetic field rise up to the 90% reach point of output voltage rise up

⑤Output rise time, Output fall time t<sub>RISE</sub>, t<sub>FALL</sub> (μs)

Output rise up time is defined as the time from the 10% point to the 90% point of output voltage under a pulse like magnetic field input shown below.

Output fall down time is defined as the time from the 90% point to the 10% point of output voltage under a pulse like magnetic field input shown below.

⑥Output delay time t<sub>REAC</sub> (μs)

Output delay time is defined as the time from the 10% point in rise up(90% point in fall down) of input magnetic field to the 10% point in rise up(90% point in fall down) of output voltage under a pulse like magnetic field input shown below..

〈Relations of the input Magnetic field and t<sub>RES</sub>, t<sub>RISE</sub>, t<sub>FALL</sub>, t<sub>REAC</sub>〉

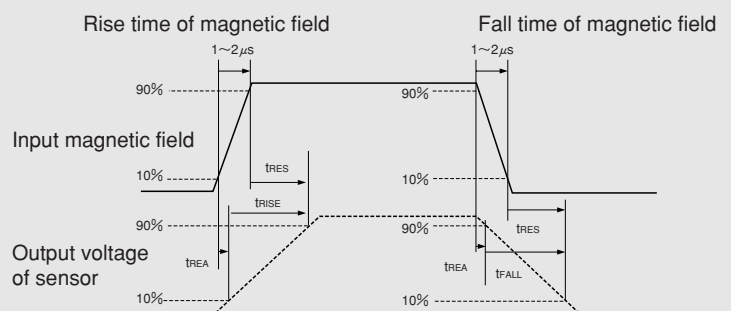

•Please be aware that our products are not intended for use in life support equipment, devices, or systems. Use of our products in such applications requires the advance written approval of our sales staff.  
 Certain applications using semiconductor devices may involve potential risks of personal injury, property damage, or loss of life. In order to minimize these risks, adequate design and operating safeguards should be provided by the customer to minimize inherent or procedural hazards. Inclusion of our products in such applications is understood to be fully at the risk of the customer using our devices or systems.

•This product contains gallium arsenide(GaAs).Handling and discarding precautions required.

●Package (Unit:mm)

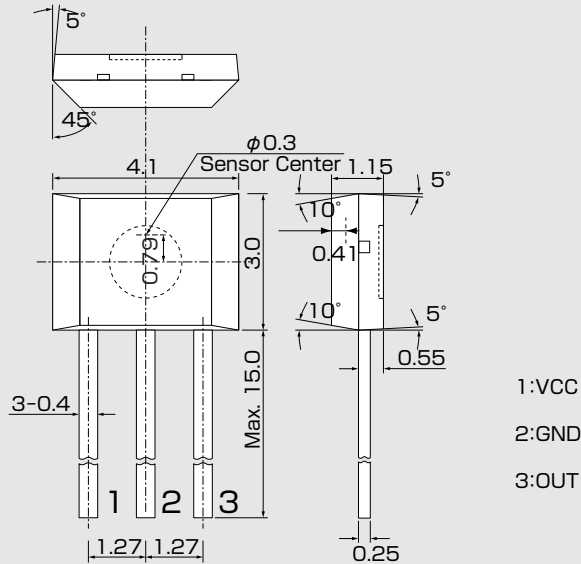

Note 1) The sensor center is located within the  $\phi 0.3$ mm circle.  
 Note 2) The metal portions on the package side (support lead) are connected to the internal circuits. The support lead should be isolate from the external circuit and the other support lead.

●Supply Voltage

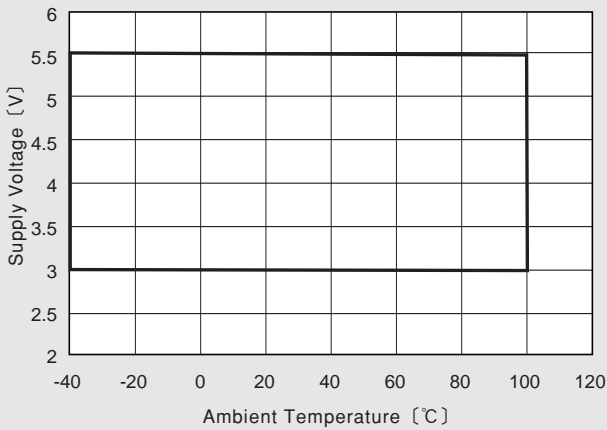

●Operational Characteristics

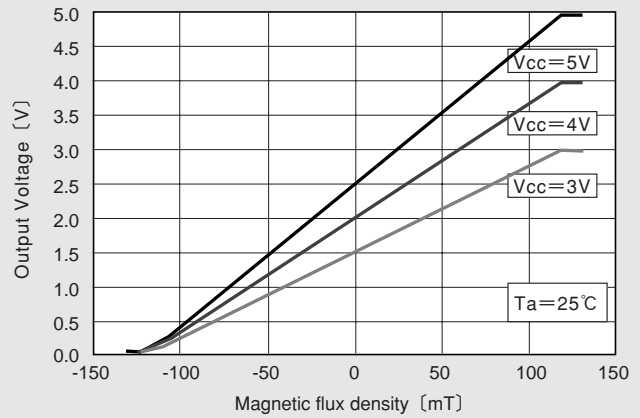

●Temperature dependence of  $V_H$

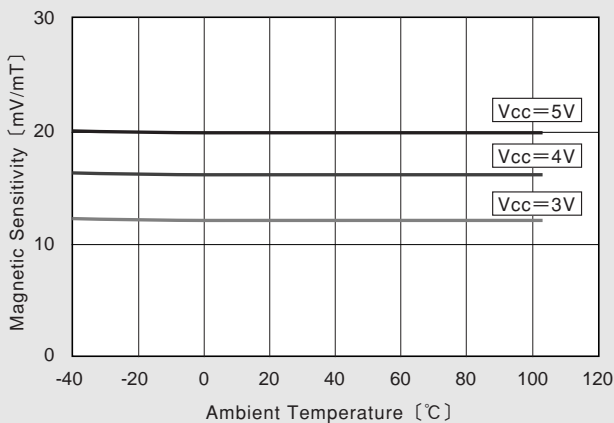

●(For reference only) Temperature dependence of  $V_{out0}$

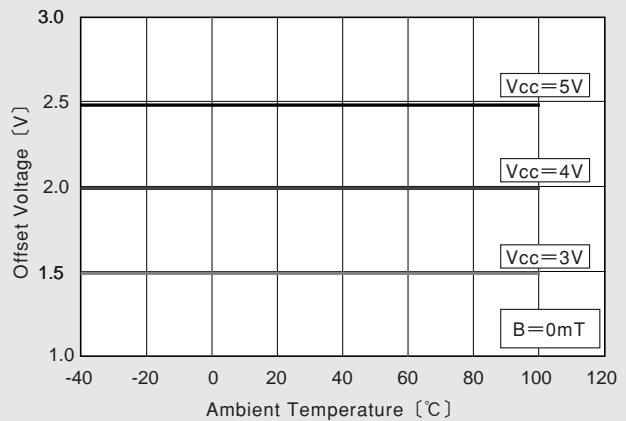

## IMPORTANT NOTICE

---

- These products and their specifications are subject to change without notice. When you consider any use or application of these products, please make inquiries the sales office of Asahi Kasei Microdevices Corporation (AKM) or authorized distributors as to current status of the products.
- Descriptions of external circuits, application circuits, software and other related information contained in this document are provided only to illustrate the operation and application examples of the semiconductor products. You are fully responsible for the incorporation of these external circuits, application circuits, software and other related information in the design of your equipments. AKM assumes no responsibility for any losses incurred by you or third parties arising from the use of these information herein. AKM assumes no liability for infringement of any patent, intellectual property, or other rights in the application or use of such information contained herein.
- Any export of these products, or devices or systems containing them, may require an export license or other official approval under the law and regulations of the country of export pertaining to customs and tariffs, currency exchange, or strategic materials.
- AKM products are neither intended nor authorized for use as critical components<sup>Note1)</sup> in any safety, life support, or other hazard related device or system<sup>Note2)</sup>, and AKM assumes no responsibility for such use, except for the use approved with the express written consent by Representative Director of AKM. As used here:
  - Note1) A critical component is one whose failure to function or perform may reasonably be expected to result, whether directly or indirectly, in the loss of the safety or effectiveness of the device or system containing it, and which must therefore meet very high standards of performance and reliability.
  - Note2) A hazard related device or system is one designed or intended for life support or maintenance of safety or for applications in medicine, aerospace, nuclear energy, or other fields, in which its failure to function or perform may reasonably be expected to result in loss of life or in significant injury or damage to person or property.
- It is the responsibility of the buyer or distributor of AKM products, who distributes, disposes of, or otherwise places the product with a third party, to notify such third party in advance of the above content and conditions, and the buyer or distributor agrees to assume any and all responsibility and liability for and hold AKM harmless from any and all claims arising from the use of said product in the absence of such notification.

June 14, 2012