

DATA SHEET
SE2580L: Dual Band 802.11a/b/g/n Wireless LAN Power Amplifier

Applications

- IEEE802.11b DSSS WLAN
- IEEE802.11g OFDM WLAN
- IEEE802.11a OFDM WLAN
- IEEE802.11n WLAN
- Access Points, PCMCIA, PC cards

Features

- 5GHz RF output port is matched to 50 Ω
- 2GHz RF output port is externally matched
- Integrated Harmonic Filter for each TX Chain
- Integrated Power Detector for each TX Chain
- 19 dBm @ 3.0 % EVM, 802.11g, 54 Mbits
- 18 dBm @ 3.0 % EVM, 802.11a, 54 Mbits
- 21 dBm O/P Power, 802.11b, 11 Mbits, ACPR = 35 dBc
- Lead free, Halogen free, RoHS compliant, MSL 1
- 3mm x 3mm x 0.9mm, QFN Package

Product Description

The SE2580L is a matched 802.11a/b/g/n WLAN RF Power Amplifier module providing all the functionality of the power amplifiers, match, harmonic filters and power detector.

Designed for ease of use, 5GHz RF port is matched to 50 Ω to simplify PCB layout and the interface to the transceiver RFIC and switch/diplexer. The SE2580L includes a transmitter power detector for each band and transmit chain with 20 dB of dynamic range for each transmit chain. Each transmit chain has a separate 1.8V CMOS digital Enable control for transmitter power ramp on/off control. The power ramp rise/fall time is less than 0.4 μsec.

The SE2580L packaged in 3mm x 3mm x 0.9mm, Halogen free, Lead free, ROHS compliant, MSL 1 QFN package.

Ordering Information

Part No.	Package	Remark
SE2580L	20 pin QFN	Samples
SE2580L-R	20 pin QFN	Tape and Reel
SE2580L-EK1	N/A	Evaluation kit

DATA SHEET
SE2580L: Dual Band 802.11a/b/g/n Wireless LAN Power Amplifier

Functional Block Diagram

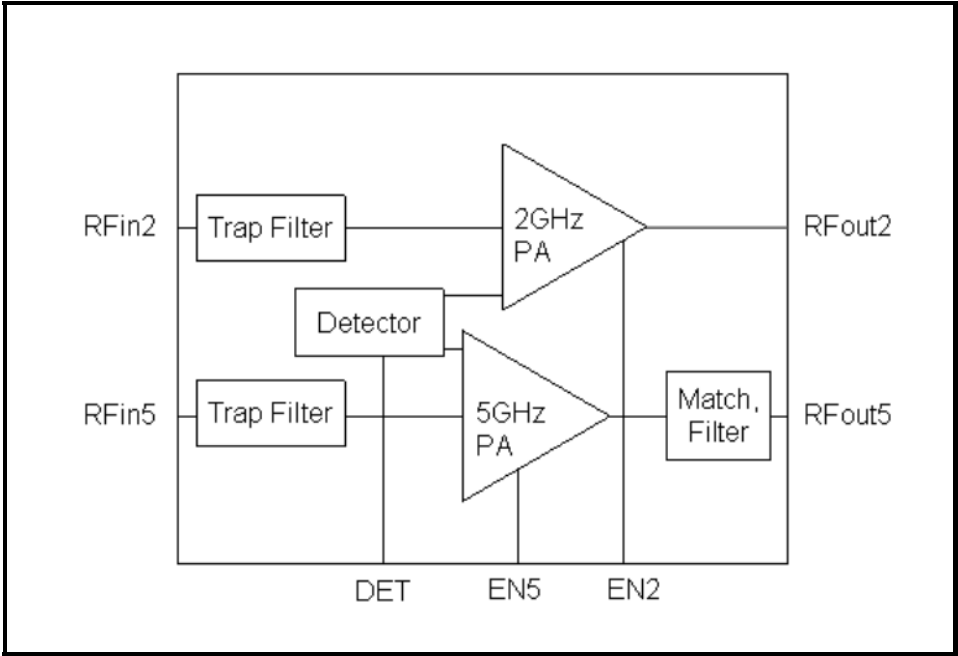

Figure 1: SE2580L Functional Block Diagram

DATA SHEET
SE2580L: Dual Band 802.11a/b/g/n Wireless LAN Power Amplifier

Pin Out Diagram

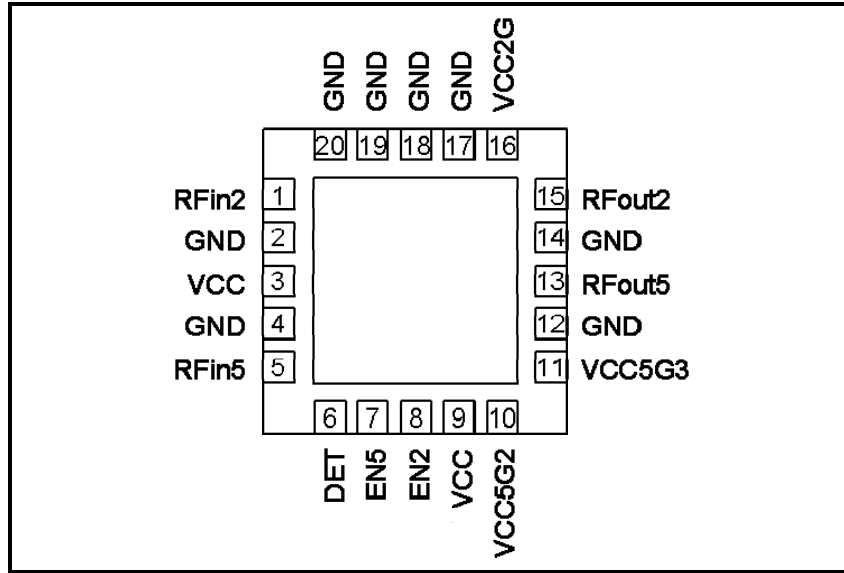

Figure 2: SE2580L Pin Out (Top View Through Package)

Pin Out Description

Pin No.	Name	Description
1	RFin2	2GHz RF Input
2	GND	Ground
3	VCC	2GHz First Stage Supply
4	GND	Ground
5	RFin5	5GHz RF Input
6	DET	2GHz and 5GHz Detector Output
7	EN5	5GHz PA Enable
8	EN2	2GHz PA Enable
9	VCC	5GHz First Stage Supply
10	VCC5G2	5GHz Power Stage supply
11	VCC5G3	5GHz Power Stage Supply
12	GND	Ground
13	RFout5	5GHz RF Output
14	GND	Ground
15	RFout2	2GHz RF Output
16	VCC2G	2GHz Power Stage supply
17-20	GND	Ground
Paddle	GND	Ground

DATA SHEET
SE2580L: Dual Band 802.11a/b/g/n Wireless LAN Power Amplifier

Absolute Maximum Ratings

These are stress ratings only. Exposure to stresses beyond these maximum ratings may cause permanent damage to, or affect the reliability of the device. Avoid operating the device outside the recommended operating conditions defined below. This device is ESD sensitive. Handling and assembly of this device should be at ESD protected workstations.

Symbol	Definition	Min.	Max.	Unit
V _{CC}	Supply Voltage	-0.3	4.0	V
PU	EN5, EN2	-0.3	4.0	V
TX _{RF}	RFin2, RFin5, RFout2, RFout5 terminated into 50 ohms	-	12.0	dBm
T _A	Operating Temperature Range	0	85	°C
T _{SRFIN2}	Storage Temperature Range	-40	150	°C

Recommended Operating Conditions

Symbol	Parameter	Min.	Typ.	Max.	Unit
V _{CC}	Supply Voltage	3.0	3.3	3.6	V
T _A	Ambient Temperature	-10	25	85	°C

DC Electrical Characteristics

Conditions: V_{CC} = 3.3 V, T_A = 25 °C, as measured on Skyworks Solutions' SE2580L-EV1 evaluation board (de-embedded to device), all unused ports terminated with 50 ohms, unless otherwise noted

Symbol	Parameter	Conditions	Min.	Typ.	Max.	Unit
I _{CC-G}	Total 802.11g Transmit Supply Current	P _{OUT} = 19 dBm, 54 Mbps OFDM signal, 64 QAM EN2 = 3.3 V, EN5 = 0 V	-	165	-	mA
I _{CQ-G}	Quiescent current, 802.11g Transmit supply current	No RF applied EN2 = 3.3V, EN5 = 0V,	-	115	-	mA
I _{CC-B}	Total 802.11b Transmit Supply Current	P _{OUT} = 21 dBm, 11 Mbps CCK signal, BT = 0.45, EN2 = 3.3 V, EN5 = 0 V	-	190	-	mA
I _{CC-A}	Total 802.11a Transmit Supply Current	P _{OUT} = 18 dBm, 54 Mbps OFDM signal, 64 QAM, EN5 = 3.3 V, EN2 = 0 V	-	230	-	mA
I _{CQ-A}	Quiescent current, 802.11a Transmit supply current	No RF applied EN5 = 3.3V, EN2 = 0V,	-	145	-	mA
I _{CC_OFF}	Total Supply Current	No RF, EN2 = EN5 = 0 V	-	10	100	μA

DATA SHEET
SE2580L: Dual Band 802.11a/b/g/n Wireless LAN Power Amplifier

Logic Characteristics

Conditions: $V_{CC} = 3.3\text{ V}$, $T_A = 25\text{ }^\circ\text{C}$, as measured on Skyworks Solutions' SE2580L-EV1 evaluation board (de-embedded to device), all unused ports terminated with 50 ohms, unless otherwise noted.

Symbol	Parameter	Conditions	Min.	Typ.	Max.	Unit
V_{ENH}	Logic High Voltage for EN2, EN5 (Module On)	-	1.8	-	V_{CC}	V
V_{ENL}	Logic Low Voltage EN2, EN5 (Module Off)	-	0	-	0.5	V
I_{ENH}	Input Current Logic High Voltage (EN2, EN5)	-	-	350	400	μA
I_{ENL}	Input Current Logic Low Voltage (EN2, EN5)	At $V_{ENL} = 0.4\text{V}$	-	45	-	μA

DATA SHEET
SE2580L: Dual Band 802.11a/b/g/n Wireless LAN Power Amplifier

2.4 GHz AC Electrical Characteristics

2.4 GHz Transmit Characteristics

Conditions: $V_{CC} = EN2 = 3.3\text{ V}$, $EN5 = 0\text{ V}$, $T_A = 25\text{ }^\circ\text{C}$, as measured on Skyworks Solutions' SE2580L-EV1 evaluation board, all unused ports terminated with 50 ohms, unless otherwise noted.

Symbol	Parameter	Condition	Min.	Typ.	Max.	Unit
F_{IN}	Frequency Range	-	2400	-	2500	MHz
$P_{802.11g}$	Output power	54 Mbps OFDM signal, 64QAM, EVM = 3.0 %	-	19	-	dBm
$P_{802.11b}$	Output power	11 Mbps CCK signal, BT = 0.45 ACPR($\pm 11\text{MHz}$ offset) < -35 ACPR($\pm 22\text{MHz}$ offset) < -56	-	21	-	dBm
P_{1dB}	P1dB	-	-	27	-	dBm
S_{21}	Small Signal Gain	-	26	-	32	dB
ΔS_{21}	Small Signal Gain Variation Over Band	-	-	1.0	2.0	dB
2f,3f	Harmonics	$P_{out} \leq 21\text{ dBm}$, 11Mbps, CCK	-	-50	-45	dBm/MHz
t_{dr} , t_{df}	Delay and rise/fall Time	50 % of EN2 edge and 90/10 % of final output power level	-	-	0.25	μs
S_{11}	Input Return Loss	-	-	-7	-	dB
STAB	Stability	CW, $P_{OUT} = 21\text{ dBm}$ 0.1 GHz – 21 GHz Load VSWR = 6:1	All non-harmonically related outputs less than -42 dBm/MHz			
R_u	Ruggedness	CW, $P_{OUT} = 21\text{ dBm}$, Load VSWR = 10:1	No Irreversible damage			

DATA SHEET
SE2580L: Dual Band 802.11a/b/g/n Wireless LAN Power Amplifier

5 GHz AC Electrical Characteristics

5 GHz Transmit Characteristics

Conditions: $V_{CC} = EN5 = 3.3\text{ V}$, $EN2 = 0\text{ V}$, $T_A = 25\text{ }^\circ\text{C}$, as measured on Skyworks Solutions' SE2580L-EV1 evaluation board, all unused ports terminated with 50 ohms, unless otherwise noted.

Symbol	Parameter	Condition	Min.	Typ.	Max.	Unit
F_{IN}	Frequency Range	-	4900	-	5875	MHz
$P_{802.11a}$	Nominal Output Power	54 Mbps OFDM signal, 64 QAM, EVM = 3.0 %	-	18	-	dBm
P_{1dB}	P1dB	-	-	24	-	dBm
S_{21}	Small Signal Gain	-	27	-	34	dB
ΔS_{21}	Small Signal Gain Variation Over 40 MHz Channel		-	-	0.5	dB
	Small Signal Gain Variation Over sub-bands	4.9 – 5.1 GHz 5.15 – 5.7 GHz 5.7 – 5.85 GHz	-	1	3	dB
2f,3f	Harmonics @19dBm, 54Mbps, 802.11a	-	-	-50	-	dBm/MHz
t_{dr}, t_{df}	Delay and rise/fall Time	50 % of V_{EN} edge and 90/10 % of final output power level	-	-	0.25	μs
S_{11}	Input Return Loss	-	-	-8	-	dB
STAB	Stability	64 QAM, $P_{OUT} = 19\text{ dBm}$ 0.1 GHz – 21 GHz Load VSWR = 6:1	All non-harmonically related outputs less than -42 dBm/MHz			
R_u	Ruggedness	CW, $P_{OUT} = 21\text{ dBm}$, Load VSWR = 10:1	No Irreversible damage			

DATA SHEET
SE2580L: Dual Band 802.11a/b/g/n Wireless LAN Power Amplifier

2.4 GHz Power Detector Characteristic

Conditions: $V_{CC} = EN2 = 3.3\text{ V}$, $EN5 = 0\text{V}$, $T_A = 25\text{ }^\circ\text{C}$, as measured on Skyworks Solutions' SE2580L-EV1 evaluation board (de-embedded to device), all unused ports terminated with $50\ \Omega$, unless otherwise noted.

Symbol	Parameter	Condition	Min.	Typ.	Max.	Unit
F _{OUT}	Frequency Range	-	2400	-	2500	MHz
PDR	Power detect range, peak power	Measured at RFout2	0	-	22	dBm
PDZ _{OUT}	DC Output impedance	-	-	2400	-	Ω
PDV _{P21}	Output Voltage, P _{OUT} = 21dBm	-	-	0.75	-	V
PDV _{p19}	Output Voltage, P _{OUT} = 19dBm	-	-	0.65	-	V
PDV _{pnoRF}	Output Voltage, P _{OUT} = No RF	-	-	0.30	-	V
LPF _{-3dB}	Power detect low pass filter -3dB corner frequency	Load = high impedance Typ: 500 k Ω	-	300	-	KHz

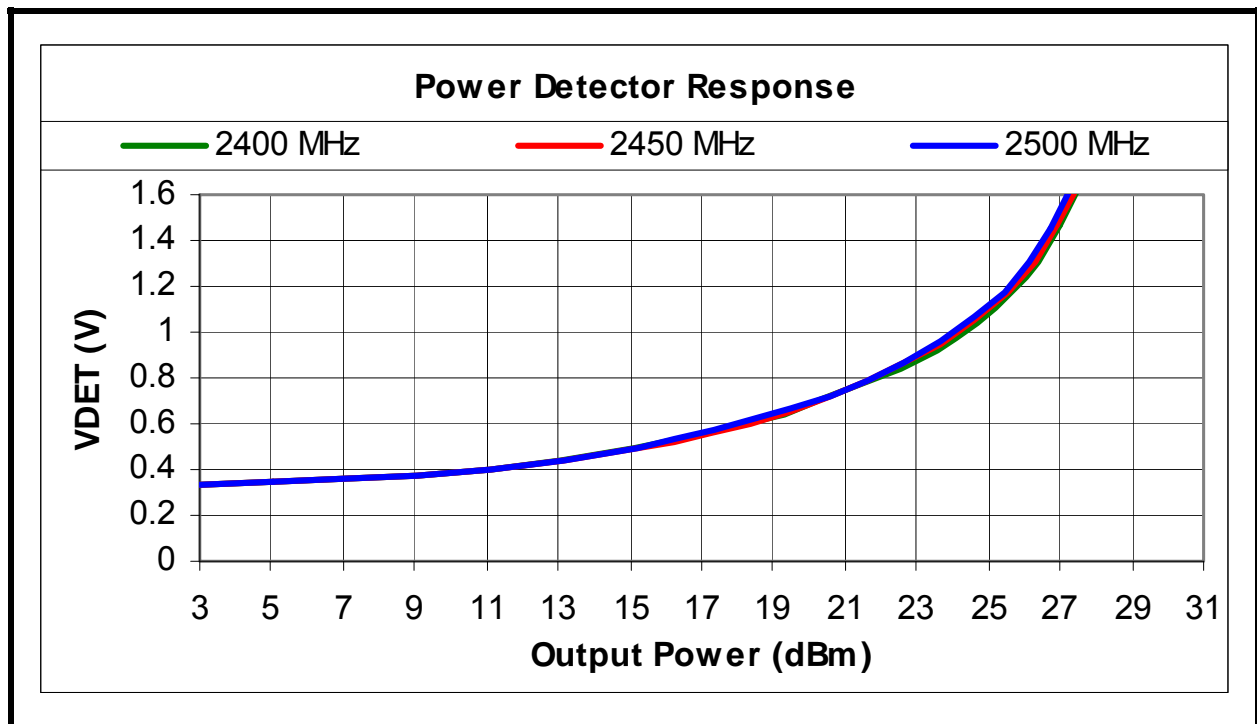

Figure 3: SE2580L Power Detector vs. Output Power over Frequency into 1Mohm

DATA SHEET

SE2580L: Dual Band 802.11a/b/g/n Wireless LAN Power Amplifier

5 GHz Power Detector Characteristic

Conditions: $V_{CC} = EN5 = 3.3$, $EN2 = 0V$, $T_A = 25\text{ }^\circ\text{C}$, as measured on Skyworks Solutions' SE2580L-EV1 evaluation board (de-embedded to device), all unused ports terminated with $50\ \Omega$, unless otherwise noted.

Symbol	Parameter	Condition	Min.	Typ.	Max.	Unit
F _{OUT}	Frequency Range	-	4900	-	5850	MHz
PDR	Power detect range, peak power	Measured at ANT	0	-	21	dBm
PDZ _{OUT}	DC Output impedance	-	-	2400	-	Ω
PDV _{p18}	Output Voltage, P _{OUT} = 18dBm	-	-	0.72	-	V
PDV _{p15}	Output Voltage, P _{OUT} = 15dBm	-	-	0.55	-	V
PDV _{NoRF}	Output Voltage, P _{OUT} = No RF	-	-	0.30	-	V
LPF _{-3dB}	Power detect low pass filter -3dB corner frequency	Load = high impedance Typ: 500 k Ω	-	300	-	KHz

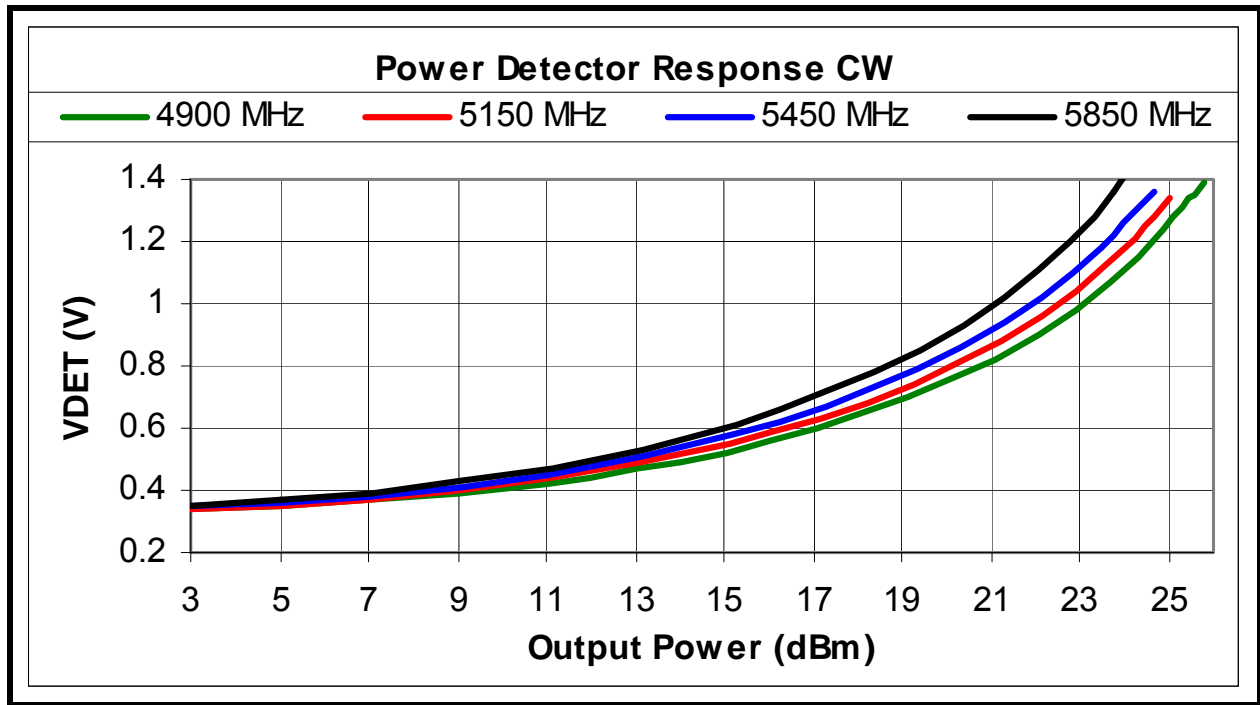

Figure 4: Preliminary SE2580L Power Detector vs. Output Power over Frequency into 1Mohm



SKYWORKS®

DATA SHEET
SE2580L: Dual Band 802.11a/b/g/n Wireless LAN Power Amplifier

Package Diagram

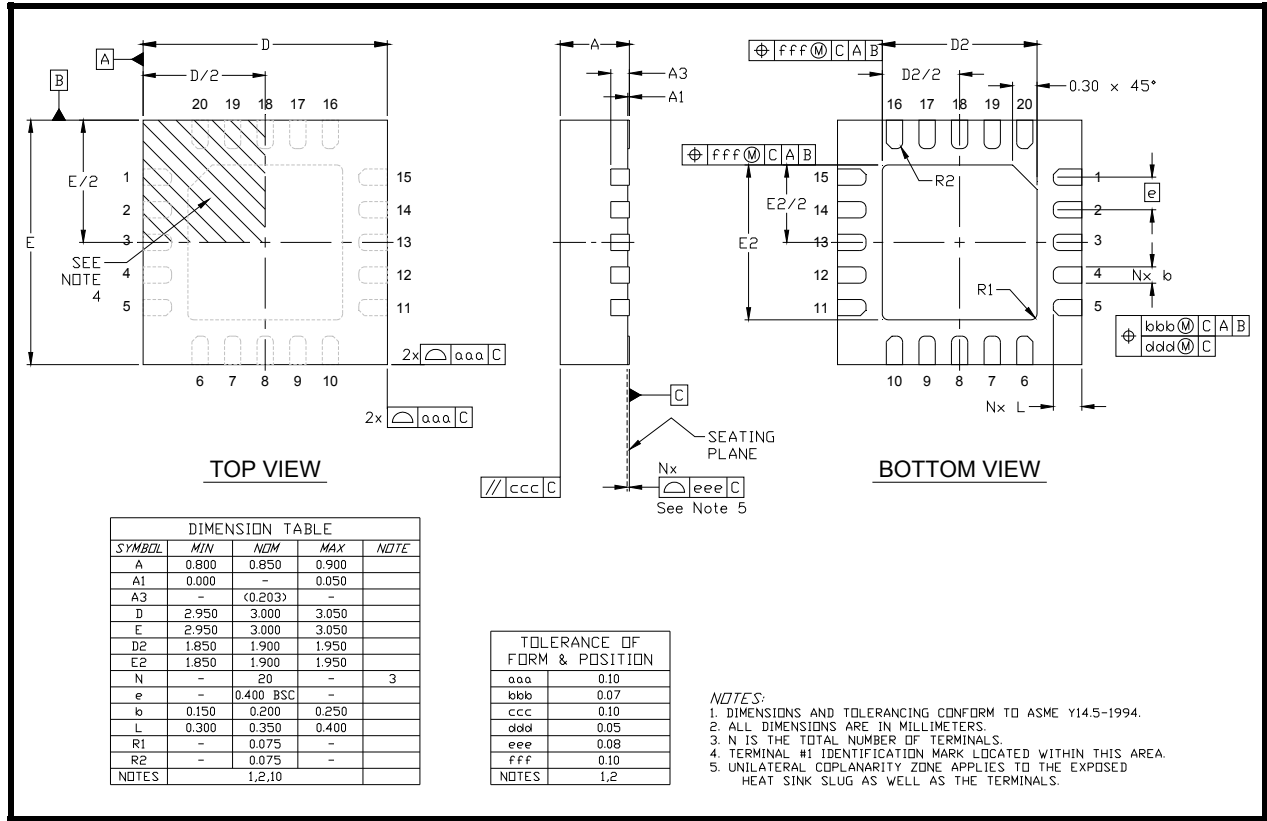

Figure 5: Package Diagram



DATA SHEET

SE2580L: Dual Band 802.11a/b/g/n Wireless LAN Power Amplifier

Recommended Land and Solder Patterns

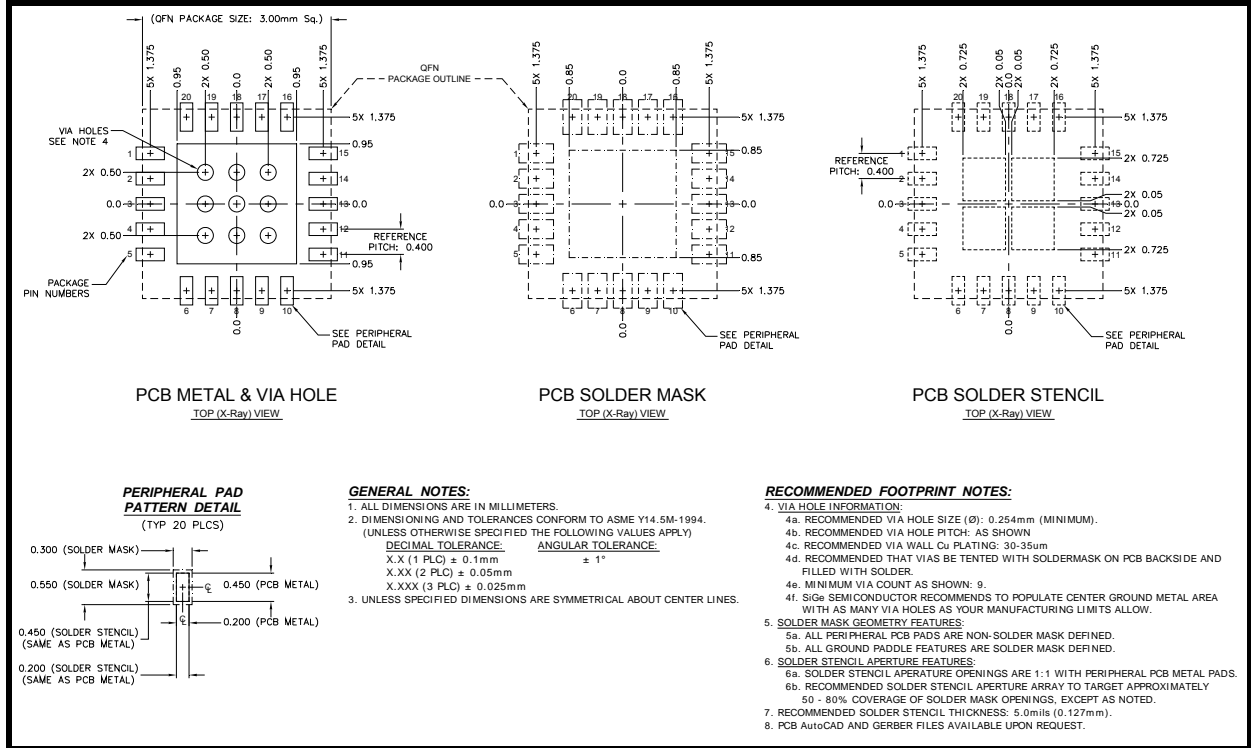



DATA SHEET
SE2580L: Dual Band 802.11a/b/g/n Wireless LAN Power Amplifier

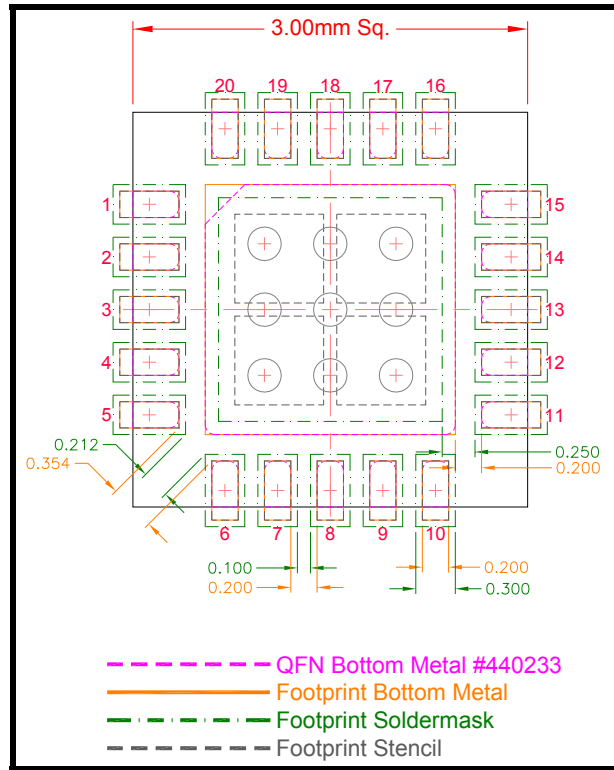

Figure 6: Recommended Land and Solder Patterns

DATA SHEET
SE2580L: Dual Band 802.11a/b/g/n Wireless LAN Power Amplifier

Package Handling Information

Because of its sensitivity to moisture absorption, instructions on the shipping container label must be followed regarding exposure to moisture after the container seal is broken, otherwise, problems related to moisture absorption may occur when the part is subjected to high temperature during solder assembly. The SE2580L is capable of withstanding a Pb free solder reflow. Care must be taken when attaching this product, whether it is done manually or in a production solder reflow environment. If the part is manually attached, precaution should be taken to insure that the device is not subjected to temperatures above its rated peak temperature for an extended period of time. For details on both attachment techniques, precautions, and handling procedures recommended, please refer to:

- “Quad Flat No-Lead Module Solder Reflow & Rework Information”, *Document Number QAD-00045*
- “Handling, Packing, Shipping and Use of Moisture Sensitive QFN”, *Document Number QAD-00044*



Caution! Class 1C ESD sensitive device

Product Branding

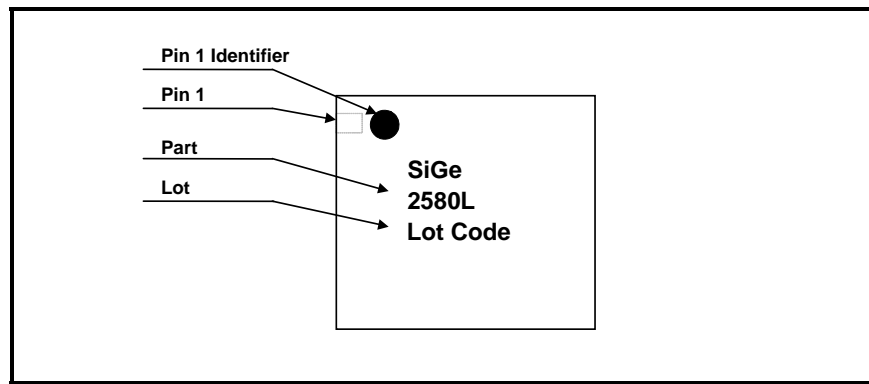

Figure 8: SE2580L Branding Information

DATA SHEET
SE2580L: Dual Band 802.11a/b/g/n Wireless LAN Power Amplifier

Tape and Reel Information

Parameter	Value
Devices Per Reel	3000
Reel Diameter	13 inches
Tape Width	12 millimeters

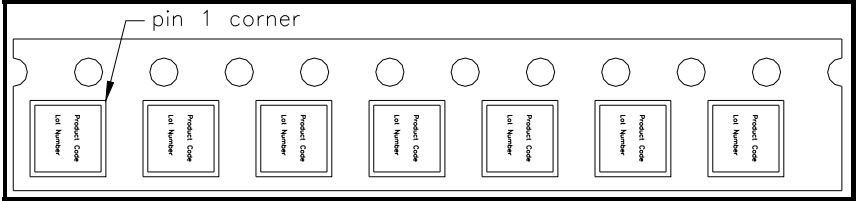

Figure 9: Detailed Tape and Reel Information (All dimensions in Millimeters)



DATA SHEET
SE2580L: Dual Band 802.11a/b/g/n Wireless LAN Power Amplifier

Document Change History

Revision	Date	Notes
1.0	May 6, 2009	Created
1.1	Jul 30, 2009	Updated Ruggedness Specification
1.2	Dec 15, 2009	Corrected pin out definition, updated performance per design validation test
1.3	Aug 20, 2010	Updated ESD classification from Class 0 to Class 1C Corrected pin description.
1.4	Sep 4, 2010	Update I _{EN} (Low) Update LO Gain at 5GHz band Update S11 return loss Update Rise/Fall time
1.5	Sep 30, 2010	Removed LO filter specifications.
1.6	Nov 15, 2010	Updated marking diagram
1.7	Apr 03, 2012	Updated with Skyworks logo and disclaimer statement

Copyright © 2012 Skyworks Solutions, Inc. All Rights Reserved.

Information in this document is provided in connection with Skyworks Solutions, Inc. ("Skyworks") products or services. These materials, including the information contained herein, are provided by Skyworks as a service to its customers and may be used for informational purposes only by the customer. Skyworks assumes no responsibility for errors or omissions in these materials or the information contained herein. Skyworks may change its documentation, products, services, specifications or product descriptions at any time, without notice. Skyworks makes no commitment to update the materials or information and shall have no responsibility whatsoever for conflicts, incompatibilities, or other difficulties arising from any future changes.

No license, whether express, implied, by estoppel or otherwise, is granted to any intellectual property rights by this document. Skyworks assumes no liability for any materials, products or information provided hereunder, including the sale, distribution, reproduction or use of Skyworks products, information or materials, except as may be provided in Skyworks Terms and Conditions of Sale.

THE MATERIALS, PRODUCTS AND INFORMATION ARE PROVIDED "AS IS" WITHOUT WARRANTY OF ANY KIND, WHETHER EXPRESS, IMPLIED, STATUTORY, OR OTHERWISE, INCLUDING FITNESS FOR A PARTICULAR PURPOSE OR USE, MERCHANTABILITY, PERFORMANCE, QUALITY OR NON-INFRINGEMENT OF ANY INTELLECTUAL PROPERTY RIGHT; ALL SUCH WARRANTIES ARE HEREBY EXPRESSLY DISCLAIMED. SKYWORKS DOES NOT WARRANT THE ACCURACY OR COMPLETENESS OF THE INFORMATION, TEXT, GRAPHICS OR OTHER ITEMS CONTAINED WITHIN THESE MATERIALS. SKYWORKS SHALL NOT BE LIABLE FOR ANY DAMAGES, INCLUDING BUT NOT LIMITED TO ANY SPECIAL, INDIRECT, INCIDENTAL, STATUTORY, OR CONSEQUENTIAL DAMAGES, INCLUDING WITHOUT LIMITATION, LOST REVENUES OR LOST PROFITS THAT MAY RESULT FROM THE USE OF THE MATERIALS OR INFORMATION, WHETHER OR NOT THE RECIPIENT OF MATERIALS HAS BEEN ADVISED OF THE POSSIBILITY OF SUCH DAMAGE.

Skyworks products are not intended for use in medical, lifesaving or life-sustaining applications, or other equipment in which the failure of the Skyworks products could lead to personal injury, death, physical or environmental damage. Skyworks customers using or selling Skyworks products for use in such applications do so at their own risk and agree to fully indemnify Skyworks for any damages resulting from such improper use or sale.

Customers are responsible for their products and applications using Skyworks products, which may deviate from published specifications as a result of design defects, errors, or operation of products outside of published parameters or design specifications. Customers should include design and operating safeguards to minimize these and other risks. Skyworks assumes no liability for applications assistance, customer product design, or damage to any equipment resulting from the use of Skyworks products outside of stated published specifications or parameters.

Skyworks, the Skyworks symbol, and "Breakthrough Simplicity" are trademarks or registered trademarks of Skyworks Solutions, Inc., in the United States and other countries. Third-party brands and names are for identification purposes only, and are the property of their respective owners. Additional information, including relevant terms and conditions, posted at www.skyworksinc.com, are incorporated by reference.