

DATA SHEET
SE2604L: 2.4 GHz High Power Wireless LAN Power Amplifier

Applications

- IEEE802.11b DSSS WLAN
- IEEE802.11g,n OFDM WLAN
- High Power Wireless Networking Products

Features

- Dual Mode IEEE802.11b, IEEE802.11g, IEEE802.11n
- 23 dBm, EVM = 3%, 802.11g, OFDM 54 Mbps
- 26 dBm, ACPR < -32 dBc, 802.11b
- Integrated PA, Input Match, 2.8V reference voltage generator
- Integrated Temperature Compensated, Positive Slope Power Detector
- Pb-free, RoHS compliant and Halogen-free
- 3 mm x 3 mm x 0.6 mm QFN, MSL 3

Product Description

The SE2604L is a high power 802.11bgn WLAN power amplifier module providing the functionality of the power amplifier, power detector, reference voltage generator and input match.

The SE2604L is designed for ease of use and maximum flexibility, with an integrated input match, and external output match to adjust the load line for either 3.3V, 23dBm operation.

The SE2604L includes a temperature compensated transmit power detector with over 20 dB of dynamic range and <1.2dB variation under 3:1 mismatch at the antenna.

The SE2604L includes a digital enable control due to an integrated reference voltage generator. The power ramp rise/fall time is 0.5 μ s typical.

Ordering Information

Part No.	Package	Remark
SE2604L	16 pin QFN	Samples
SE2604L-R	16 pin QFN	Tape & Reel
SE2604L-EK1	N/A	Evaluation kit

Functional Block Diagram

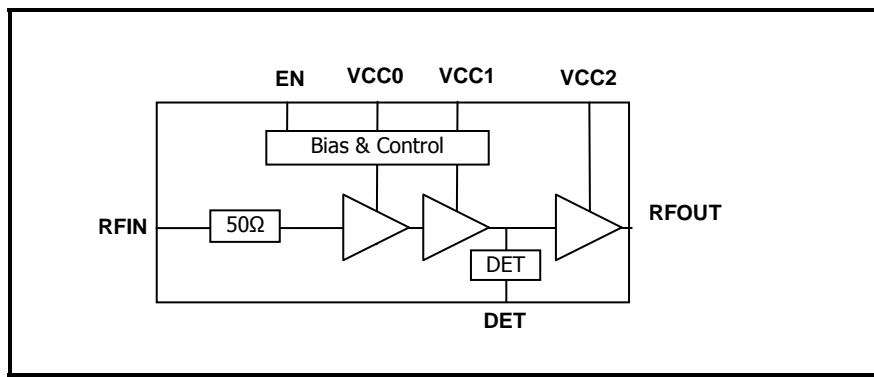

Figure 1: Functional Block Diagram

DATA SHEET
SE2604L: 2.4 GHz High Power Wireless LAN Power Amplifier

Pin Out Diagram

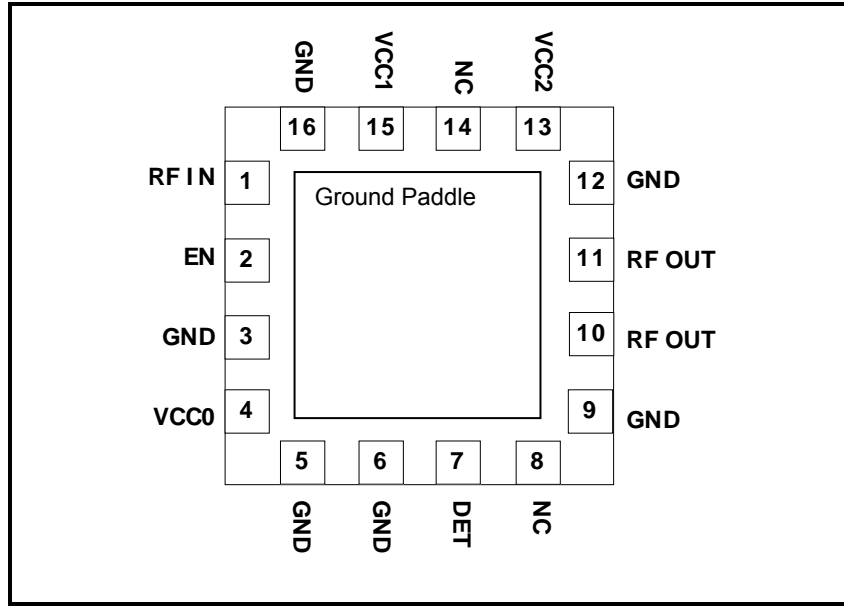

Figure 2: SE2604L Pin Out (Top View Through Package)

Pin Out Description

Pin No.	Name	Description
1	RF IN	RF Input
2	EN	Power Amplifier Enable
3	GND	Ground
4	VCC0	Power Supply for Bias Circuit
5	GND	Ground
6	GND	Ground
7	DET	Power Detector Output
8	NC	No Connect. May be left floating or grounded.
9	GND	Ground
10	RF OUT	RF Output
11	RF OUT	RF Output
12	GND	Ground
13	VCC2	Power Supply for 2 nd Stage
14	NC	No Connect. May be left floating or grounded.
15	VCC1	Power Supply driver stages
16	GND	Ground
Die paddle	GND	Ground

DATA SHEET
SE2604L: 2.4 GHz High Power Wireless LAN Power Amplifier

Absolute Maximum Ratings

These are stress ratings only. Exposure to stresses beyond these maximum ratings may cause permanent damage to, or affect the reliability of the device. Avoid operating the device outside the recommended operating conditions defined below. This device is ESD sensitive. Handling and assembly of this device should be at ESD protected workstations.

Symbol	Definition	Min.	Max.	Unit
VCC	Supply Voltage on VCC	-0.3	4.0	V
V _{IN}	DC input on EN	-0.3	3.6	V
TX	RF Input Power with RF Out terminated in 50Ω	-	12.0	dBm
T _A	Operating Temperature Range	-40	85	°C
T _{STG}	Storage Temperature Range	-40	150	°C
ESD _{HBM}	JEDEC JESD22-A114 all pins	-	1,000	V

Recommended Operating Conditions

Symbol	Parameter	Min.	Typ.	Max.	Unit
T _A	Ambient temperature	-40	25	85	°C
VCC	Supply voltage, relative to GND = 0 V	2.9	3.3	3.6	V

DC Electrical Characteristics

Conditions: VCC = EN = 3.3 V, T_A = 25 °C, as measured on Skyworks Solutions' SE2604L-EV1 evaluation board (de-embedded to device), all unused ports terminated with 50 ohms, unless otherwise noted

Symbol	Parameter	Conditions	Min.	Typ.	Max.	Unit
I _{CC-G}	Total Supply Current	P _{OUT} = 23 dBm, 54 Mbps OFDM signal, 64QAM	-	410	-	mA
I _{CC-B}	Total Supply Current	P _{OUT} = 26 dBm, 11 Mbps CCK signal, BT = 0.45	-	450	-	mA
I _{CC-OFF}	Total Supply Current	EN = 0 V, No RF Applied	-	10	100	μA

Logic Characteristics

Conditions: VCC = EN = 3.3 V, T_A = 25 °C, as measured on Skyworks Solutions' SE2604L-EV1 evaluation board (de-embedded to device), all unused ports terminated with 50 ohms, unless otherwise noted.

Symbol	Parameter	Conditions	Min.	Typ.	Max.	Unit
V _{ENH}	Logic High Voltage (Module On)	-	1.8	-	V _{CC}	V
V _{ENL}	Logic Low Voltage (Module Off)	-	0	-	0.4	V
I _{ENH}	Input Current Logic High Voltage	-	-	300	-	μA
I _{ENL}	Input Current Logic Low Voltage	V _{ENL} = 0.4V	-	1	50	μA

DATA SHEET
SE2604L: 2.4 GHz High Power Wireless LAN Power Amplifier

Symbol	Parameter	Conditions	Min.	Typ.	Max.	Unit
Z _{EN}	Enable pin input impedance	Passive Pull Down		10		kΩ

AC Electrical Characteristics

802.11g/n Transmit Characteristics

Conditions: V_{CC} = EN = 3.3 V, T_A = 25 °C, as measured on Skyworks Solutions' SE2604L-EV1 evaluation board (de-embedded to device), all unused ports terminated with 50 ohms, unless otherwise noted.

Symbol	Parameter	Condition	Min.	Typ.	Max.	Unit
F _{IN}	Frequency Range	-	2400	-	2500	MHz
P _{OUT}	Output Power	54 Mbps OFDM signal, 64 QAM, 3% EVM	-	23	-	dBm
		11Mbps CCK signal, BT = 0.045, Mask	-	26	-	
		802.11n, HT20, all data rates, Mask	-	27	-	
		802.11n, HT40, All data rates, Mask	-	24	-	
P _{1dB}	P1dB	-	-	30	-	dBm
S ₂₁	Small Signal Gain	-	30	32	-	dB
ΔS ₂₁	Small Signal Gain Variation	Gain variation over single 40MHz channel	-	0.5	-	dB
		Gain Variation over band	-	1.0	-	
2f	Harmonics	P _{OUT} = 26 dBm, 1 Mbps, 802.11b	-	-50	-45	dBm/MHz
3f			-	-50	-45	dBm/MHz
t _{dr} , t _{df}	Delay and rise/fall Time	50 % of V _{EN} edge and 90/10 % of final output power level	-	0.5	-	μs
S ₁₁	Input Return Loss	-	10	15	-	dB
STAB	Stability	CW, P _{OUT} = 26 dBm 0.1 GHz – 20 GHz Load VSWR = 6:1	All non-harmonically related outputs less than -42 dBm/MHz			
RU	Ruggedness	CW, P _{IN} = +12dBm, Load VSWR = 6:1	No permanent damage.			

DATA SHEET
SE2604L: 2.4 GHz High Power Wireless LAN Power Amplifier

Power Detector Characteristics

Conditions: VCC = EN = 3.3 V, TA = 25 °C, as measured on Skyworks Solutions' SE2604L-EV1 evaluation board, unless otherwise noted.

Symbol	Parameter	Condition	Min.	Typ.	Max.	Unit
F _{OUT}	Frequency Range	-	2400	-	2500	MHz
PDR	Power detect range, CW	Measured at RF out	0	-	26	dBm
PDZ _{src}	DC source impedance on PD_OUT	-	-	2.3	-	KΩ
PDZ _{LOAD}	DC load impedance	-	-	26.5	-	KΩ
PDV _{NoRF}	Output Voltage, P _{OUT} = 5dBm	Measured into 26.5KΩ	-	0.33	-	V
PDV _{p23}	Output Voltage, P _{OUT} = 23 dBm CW	Measured into 26.5KΩ	-	0.70	-	V
PDV _{p27}	Output Voltage, P _{OUT} = 27 dBm CW	Measured into 26.5KΩ	-	0.97	-	V
LPF _{-3dB}	Power detect low pass filter -3dB corner frequency	Measured into 26.5KΩ	-	2.0	-	MHz

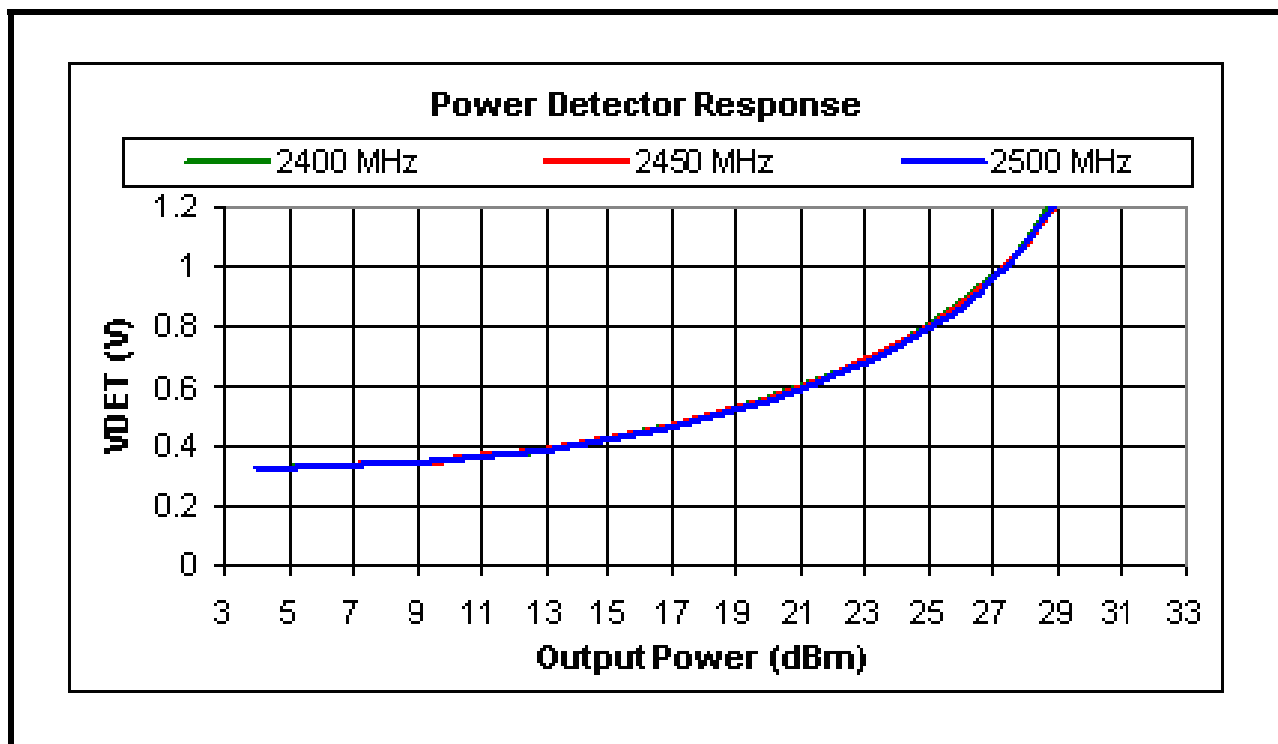

Figure 3: SE2604L Detector Characteristics

DATA SHEET
SE2604L: 2.4 GHz High Power Wireless LAN Power Amplifier

Package Diagram

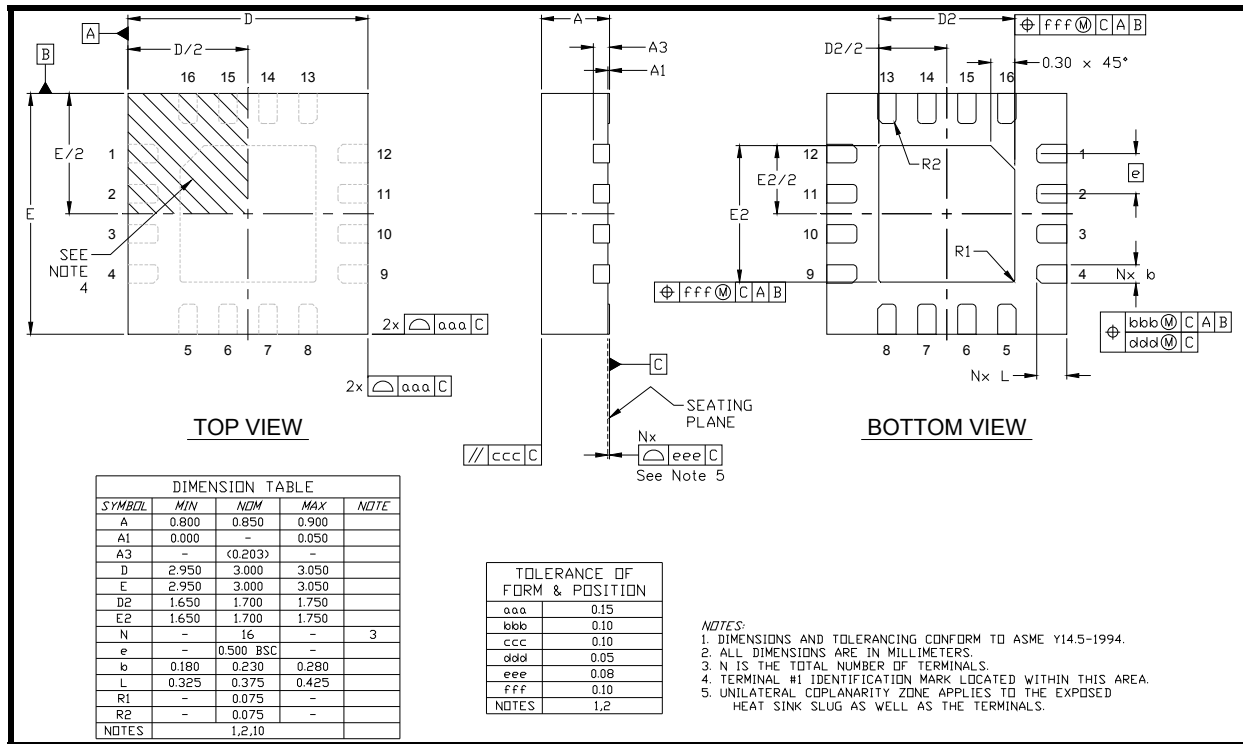

Figure 4: SE2604L Package Diagram



DATA SHEET SE2604L: 2.4 GHz High Power Wireless LAN Power Amplifier

Recommended Land and Solder Patterns

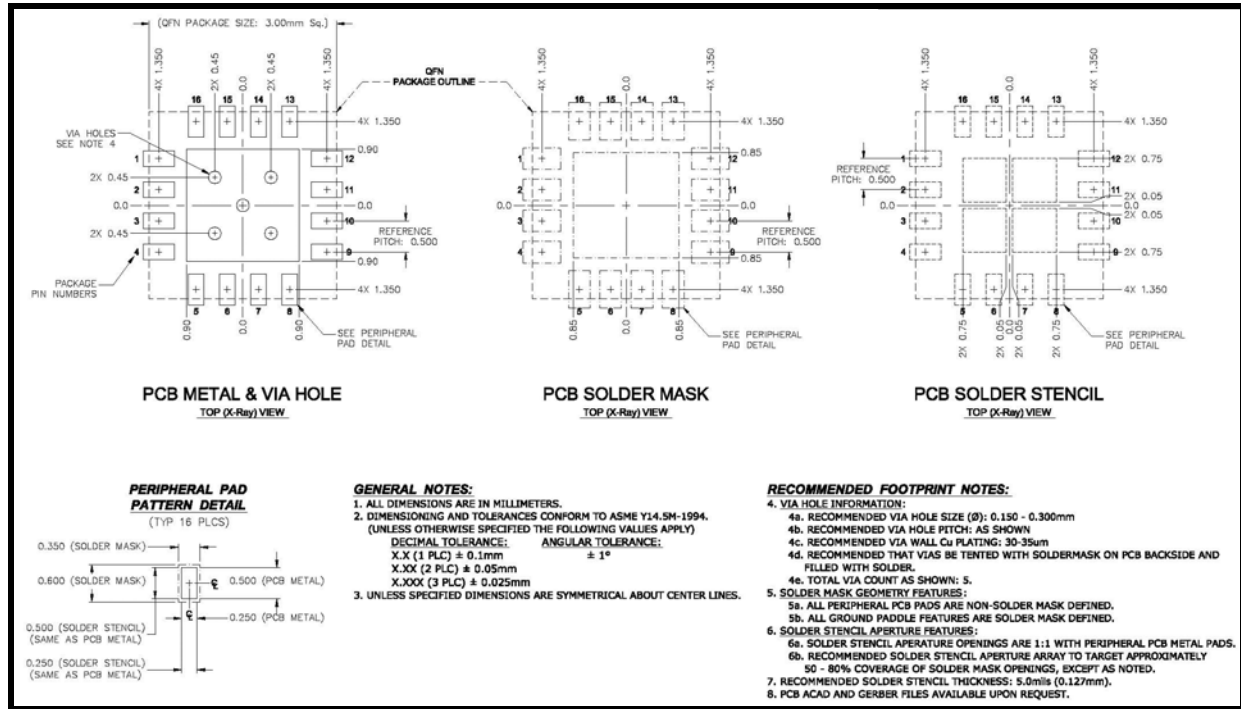

Figure 5: SE2604L Recommended Land and Solder Pattern

Package Handling Information

Because of its sensitivity to moisture absorption, instructions on the shipping container label must be followed regarding exposure to moisture after the container seal is broken, otherwise, problems related to moisture absorption may occur when the part is subjected to high temperature during solder assembly. The SE2604L is capable of withstanding a Pb free solder reflow. Care must be taken when attaching this product, whether it is done manually or in a production solder reflow environment. If the part is manually attached, precaution should be taken to insure that the device is not subjected to temperatures above its rated peak temperature for an extended period of time. For details on both attachment techniques, precautions, and handling procedures recommended, please refer to:

- “Quad Flat No-Lead Module Solder Reflow & Rework Information”, *Document Number QAD-00045*
- “Handling, Packing, Shipping and Use of Moisture Sensitive QFN”, *Document Number QAD-00044*



Caution! Class 1C ESD sensitive device

DATA SHEET
SE2604L: 2.4 GHz High Power Wireless LAN Power Amplifier

Branding Information

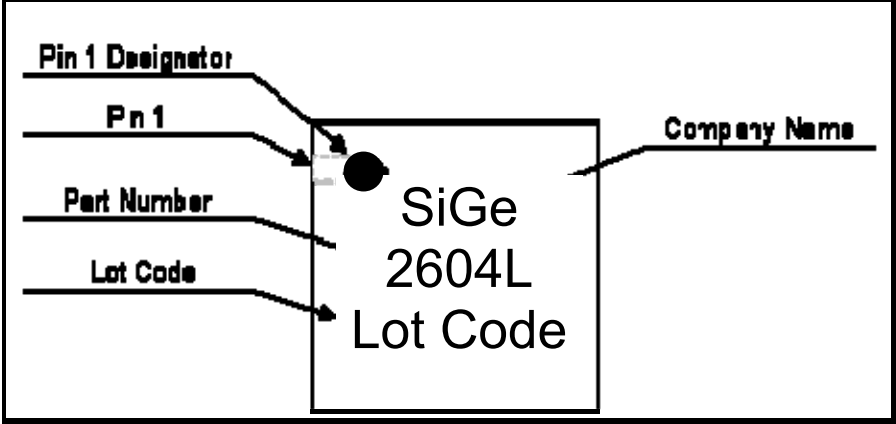

Figure 6: SE2604L Branding

Tape and Reel Information

Parameter	Value
Devices Per Reel	3000
Reel Diameter	13 inches
Tape Width	12 millimeters

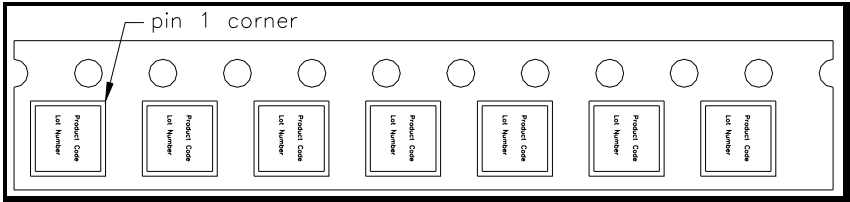

Figure 7: SE2604L-R Tape and Reel Information



DATA SHEET
SE2604L: 2.4 GHz High Power Wireless LAN Power Amplifier

Document Change History

Revision	Date	Notes
1.0	Oct 15, 2009	Created
1.1	Jan 26, 2010	Updated for Off-State Leakage
1.2	Dec 18, 2010	Updated ESD Rating Added OFDM Mask Compliance
1.3	Sep 11, 2011	Updated recommended operating temperature
1.4	Apr 11, 2012	Updated with Skyworks logo and disclaimer statement

Copyright © 2012 Skyworks Solutions, Inc. All Rights Reserved.

Information in this document is provided in connection with Skyworks Solutions, Inc. ("Skyworks") products or services. These materials, including the information contained herein, are provided by Skyworks as a service to its customers and may be used for informational purposes only by the customer. Skyworks assumes no responsibility for errors or omissions in these materials or the information contained herein. Skyworks may change its documentation, products, services, specifications or product descriptions at any time, without notice. Skyworks makes no commitment to update the materials or information and shall have no responsibility whatsoever for conflicts, incompatibilities, or other difficulties arising from any future changes.

No license, whether express, implied, by estoppel or otherwise, is granted to any intellectual property rights by this document. Skyworks assumes no liability for any materials, products or information provided hereunder, including the sale, distribution, reproduction or use of Skyworks products, information or materials, except as may be provided in Skyworks Terms and Conditions of Sale.

THE MATERIALS, PRODUCTS AND INFORMATION ARE PROVIDED "AS IS" WITHOUT WARRANTY OF ANY KIND, WHETHER EXPRESS, IMPLIED, STATUTORY, OR OTHERWISE, INCLUDING FITNESS FOR A PARTICULAR PURPOSE OR USE, MERCHANTABILITY, PERFORMANCE, QUALITY OR NON-INFRINGEMENT OF ANY INTELLECTUAL PROPERTY RIGHT; ALL SUCH WARRANTIES ARE HEREBY EXPRESSLY DISCLAIMED. SKYWORKS DOES NOT WARRANT THE ACCURACY OR COMPLETENESS OF THE INFORMATION, TEXT, GRAPHICS OR OTHER ITEMS CONTAINED WITHIN THESE MATERIALS. SKYWORKS SHALL NOT BE LIABLE FOR ANY DAMAGES, INCLUDING BUT NOT LIMITED TO ANY SPECIAL, INDIRECT, INCIDENTAL, STATUTORY, OR CONSEQUENTIAL DAMAGES, INCLUDING WITHOUT LIMITATION, LOST REVENUES OR LOST PROFITS THAT MAY RESULT FROM THE USE OF THE MATERIALS OR INFORMATION, WHETHER OR NOT THE RECIPIENT OF MATERIALS HAS BEEN ADVISED OF THE POSSIBILITY OF SUCH DAMAGE.

Skyworks products are not intended for use in medical, lifesaving or life-sustaining applications, or other equipment in which the failure of the Skyworks products could lead to personal injury, death, physical or environmental damage. Skyworks customers using or selling Skyworks products for use in such applications do so at their own risk and agree to fully indemnify Skyworks for any damages resulting from such improper use or sale.

Customers are responsible for their products and applications using Skyworks products, which may deviate from published specifications as a result of design defects, errors, or operation of products outside of published parameters or design specifications. Customers should include design and operating safeguards to minimize these and other risks. Skyworks assumes no liability for applications assistance, customer product design, or damage to any equipment resulting from the use of Skyworks products outside of stated published specifications or parameters.

Skyworks, the Skyworks symbol, and "Breakthrough Simplicity" are trademarks or registered trademarks of Skyworks Solutions, Inc., in the United States and other countries. Third-party brands and names are for identification purposes only, and are the property of their respective owners. Additional information, including relevant terms and conditions, posted at www.skyworksinc.com, are incorporated by reference.