



**SF2137E**

**869.00 MHz  
SAW Filter**

- Steep Roll-off Filter for 869.00 MHz Unlicensed Band
- Complies with Directive 2002/95/EC (RoHS)
- No Matching Required for Operation in 50Ω Environment



**Absolute Maximum Ratings**

Rating	Value	Units
Input Power Level	17	dBm
DC Voltage on any Non-ground Terminal	3	V
Operating Temperature Range	-40 to +85	°C
Storage Temperature Range in Tape and Reel	-40 to +85	°C
Maximum Soldering Profile, 5 Cycles/10 seconds Maximum	265	°C

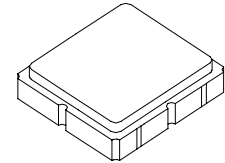

**SM3030-6**

**Electrical Characteristics**

Characteristic	Sym	Notes	Min	Typ	Max	Units
Center Frequency	$f_C$			869.00		MHz
Bandwidth, 1 dB				11		
Bandwidth, 3 dB				17		
Insertion Loss, 868 to 870 MHz	IL			2.8	4.0	dB
Amplitude Ripple, 868 to 870 MHz				0.2	1.5	dB <sub>P-P</sub>
Attenuation Referenced to 0 dB:						dB
825 to 828 MHz			40	47		
835 to 842 MHz			30	39		
891 to 894 MHz			30	42		
910 to 913 MHz			40	47		
Source Impedance	$Z_S$			50		Ω
Load Impedance	$Z_L$			50		Ω

Case Style	SM3030-6 3.0 x 3.0 mm Nominal Footprint					
Lid Symbolization, Y=year, WW=week, S=shift, Dot=pin 1 indicator	711, YWWS					
Standard Reel Quantity	Reel Size 7 Inch					500 Pieces/Reel
	Reel Size 13 Inch					3000 Pieces/Reel

**Electrical Connections**

Connection	Terminals
Port 1	2
Port 2	5
Case Ground	All others



**CAUTION: Electrostatic Sensitive Device. Observe precautions for handling.**

**Notes:**

1. Unless noted otherwise, all specifications apply over the operating temperature range with filter soldered to the specified demonstration board with impedance matching to 50 Ω and measured with 50 Ω network analyzer.
2. Unless noted otherwise, all frequency specifications are referenced to the nominal center frequency,  $f_C$ .
3. Rejection is measured as attenuation below the minimum IL point in the passband. Rejection in final user application is dependent on PCB layout and external impedance matching design. See Application Note No. 42 for details.
4. The design, manufacturing process, and specifications of this filter are subject to change.
5. US and international patents may apply.
6. RFM, stylized RFM logo, and RF Monolithics, Inc. are registered trademarks of RF Monolithics, Inc.

CH1 S31 LOG 2 dB/REF -8 dB 21-2.7256 dB 870.000 000 MHz

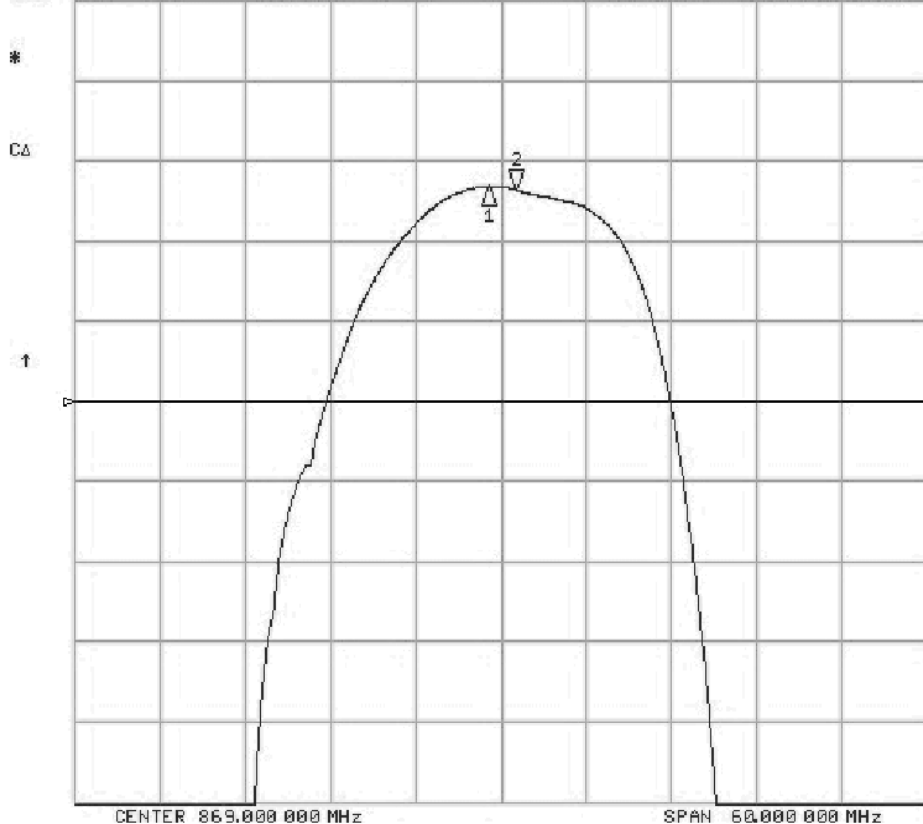

CH1 Markers  
1: -2.6412 dB  
868.000 MHz

CH1 S31 LOG 8 dB/REF -32 dB 51-44.180 dB 894.000 000 MHz

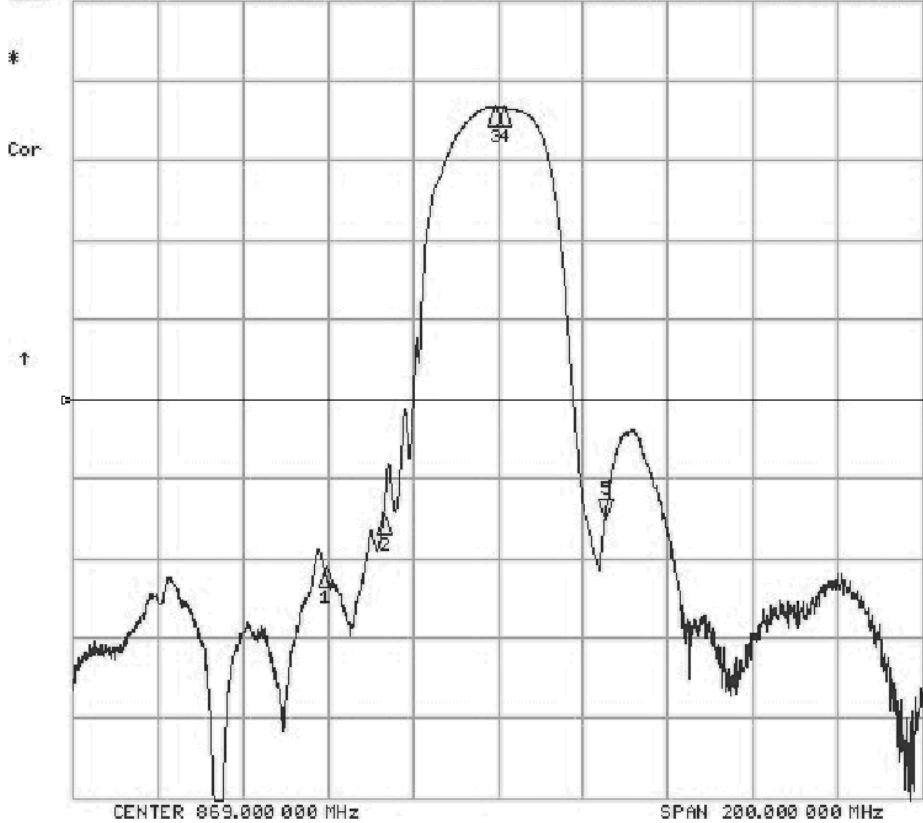

CH1 Markers  
1: -49.024 dB  
828.000 MHz  
2: -43.517 dB  
842.000 MHz  
3: -2.6378 dB  
868.000 MHz  
4: -2.7213 dB  
870.000 MHz

CH1 931 LOG 10 dB/REF -40 dB 41-47.219 dB 910.000 000 MHz

#

Cor

↑

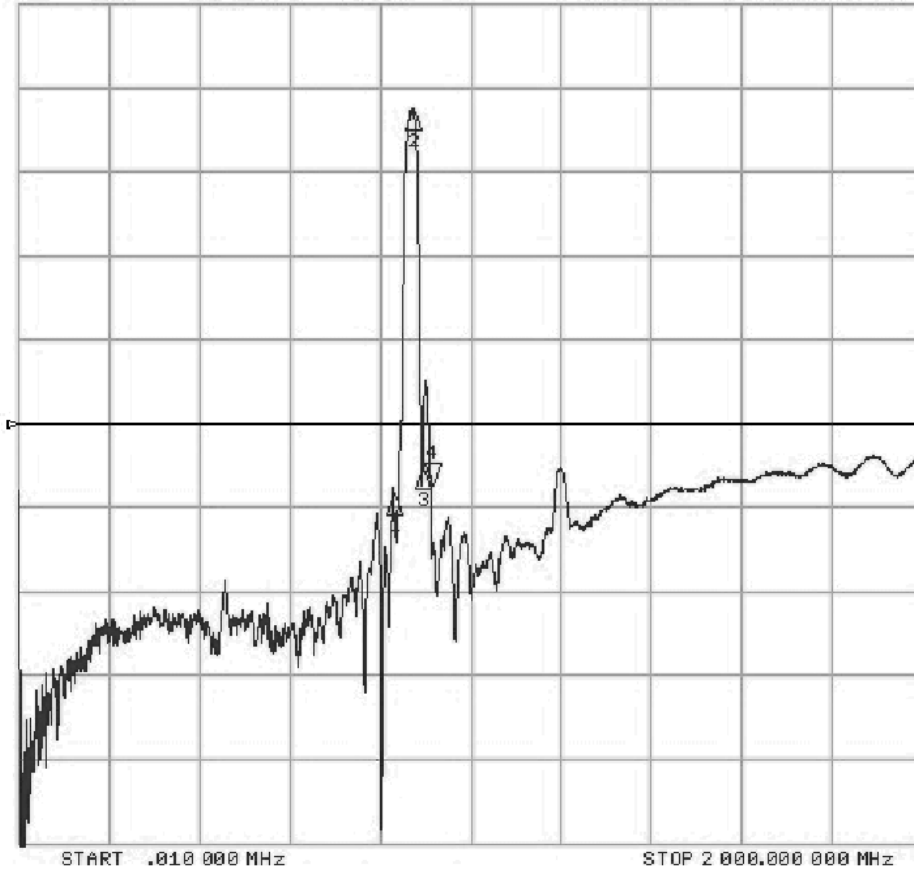

CH1 Markers

1: -48.523 dB  
820.000 MHz

2: -2.5911 dB  
869.000 MHz

3: -45.496 dB  
891.000 MHz

START .010 000 MHz

STOP 2 000.000 000 MHz

# SM3030-6 Case

## 6-Terminal Ceramic Surface-Mount Case 3.0 X 3.0 mm Nominal Footprint

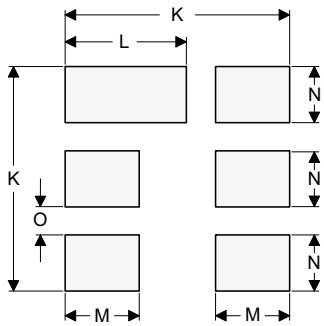
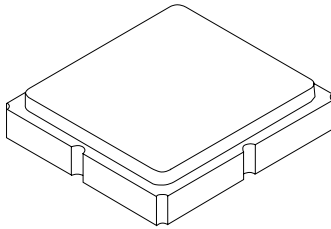

PCB Footprint Top View

### Case and PCB Footprint Dimensions

Dimension	mm			Inches		
	Min	Nom	Max	Min	Nom	Max
A	2.87	3.00	3.13	0.113	0.118	0.123
B	2.87	3.00	3.13	0.113	0.118	0.123
C	1.12	1.25	1.38	0.044	0.049	0.054
D	0.77	0.90	1.03	0.030	0.035	0.040
E	2.67	2.80	2.93	0.105	0.110	0.115
F	1.47	1.60	1.73	0.058	0.063	0.068
G	0.72	0.85	0.98	0.028	0.033	0.038
H	1.37	1.50	1.63	0.054	0.059	0.064
I	0.47	0.60	0.73	0.019	0.024	0.029
J	1.17	1.30	1.43	0.046	0.051	0.056
K		3.20			0.126	
L		1.70			0.067	
M		1.05			0.041	
N		0.81			0.032	
O		0.38			0.015	

### Case Materials

Materials	
Solder Pad Plating	0.3 to 1.0 $\mu\text{m}$ Gold over 1.27 to 8.89 $\mu\text{m}$ Nickel
Lid Plating	2.0 to 3.0 $\mu\text{m}$ Nickel
Body	$\text{Al}_2\text{O}_3$ Ceramic
Pb Free	

### Top View

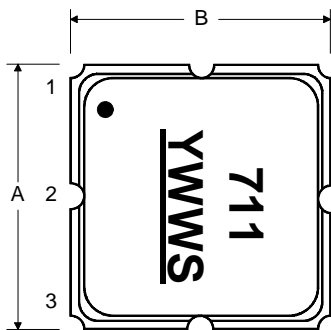

### Bottom View

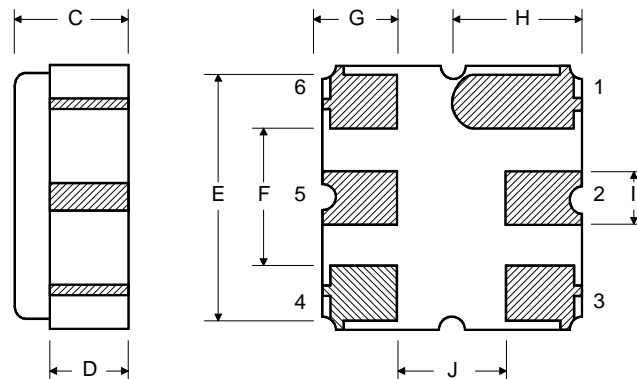



---

## Typical Solder Reflow Profile

