

DATA SHEET

SKY65137-11: Power Amplifier for 802.11a WLAN Applications

Applications

- IEEE802.11a WLAN enabled:
 - access points
 - media gateways
 - set top boxes
 - LCD TVs
- Other broadband triple-play multimedia applications

Features

- Linear output power of +24 dBm for IEEE802.11a 64-QAM EVM <2.5%
- High gain of 26 dB
- Output power detector: 20 dB dynamic range
- Power shutdown mode
- Superior gain flatness
- Internal RF match and bias circuits
- Small footprint, MCM (20-pin, 6 x 6 mm) SMT package (MSL3, 260 °C per JEDEC J-STD-020)



Skyworks Pb-free products are compliant with all applicable legislation. For additional information, refer to *Skyworks Definition of Lead (Pb)-Free*, document number SQ04-0073.

Description

Skyworks SKY65137-11 is a Microwave Monolithic Integrated Circuit (MMIC) Power Amplifier (PA) with superior output power, linearity, and efficiency. These features make the SKY65137-11 ideal for Wireless Local Area Network (WLAN) applications.

The device is fabricated using Skyworks high reliability Indium Gallium Phosphide (InGaP) Heterojunction Bipolar Transistor (HBT) technology. The device is internally matched and mounted in a 20-pin, 6 x 6 mm Multi-Chip Module (MCM) Surface-Mounted Technology (SMT) package, which allows for a highly manufacturable low cost solution.

The device package and pinout for the 20-pin MCM are shown in Figure 1. A block diagram of the SKY65137-11 is shown in Figure 2.

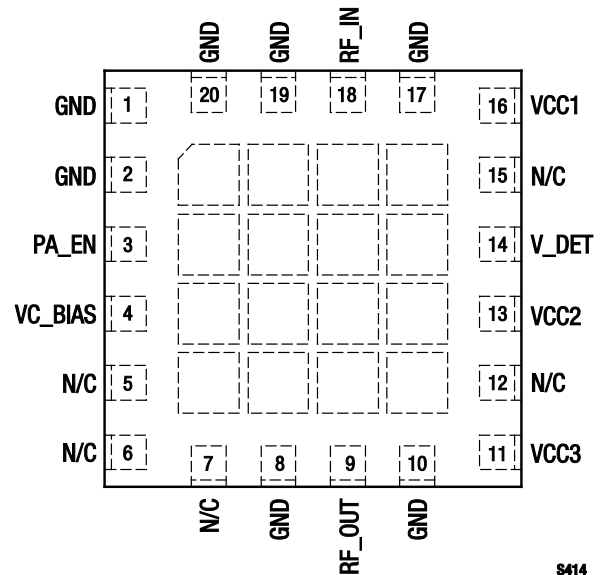

S414

Figure 1. SKY65137-11 Pinout – 20-Pin MCM (Top View)

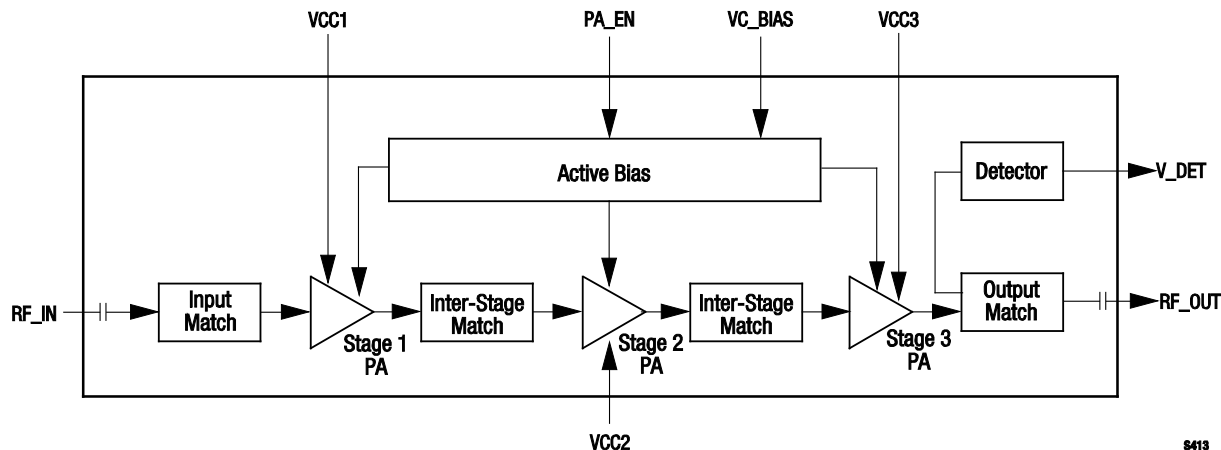

Figure 2. SKY65137-11 Block Diagram

Table 1. SKY65137-11 Signal Descriptions

Pin #	Name	Description	Pin #	Name	Description
1	GND	Ground	11	VCC3	Stage 3 collector voltage
2	GND	Ground	12	N/C	No connection
3	PA_EN	Power shutdown enable	13	VCC2	Stage 2 collector voltage
4	VC_BIAS	Bias voltage	14	V_DET	Detector output signal
5	N/C	No connection	15	N/C	No connection
6	N/C	No connection	16	VCC1	Stage 1 collector voltage
7	N/C	No connection	17	GND	Ground
8	GND	Ground	18	RF_IN	RF input
9	RF_OUT	RF output	19	GND	Ground
10	GND	Ground	20	GND	Ground

Technical Description

The SKY65137-11 PA contains all of the needed RF matching and DC biasing circuits. The device also provides an output power detector voltage.

The SKY65137-11 is a three-stage, HBT InGaP device optimized for high linearity and power efficiency. These features make the device suitable for wideband digital applications, where PA linearity and power consumption are of critical importance (e.g., WLANs).

The device has been characterized with the highest specified data rates for IEEE802.11a (54 Mbps). Under these stringent test

conditions, the device exhibits excellent spectral purity and power efficiency.

Electrical and Mechanical Specifications

Signal pin assignments and functional pin descriptions are described in Table 1. The absolute maximum ratings of the SKY65137-11 are provided in Table 2. Electrical specifications are provided in Table 3.

Typical performance characteristics of the SKY65137-11 are illustrated in Figures 3 through 19.

Table 2. SKY65137-11 Absolute Maximum Ratings (Note 1)

Parameter	Symbol	Minimum	Maximum	Units
RF output power (CW signal)	P _{OUT}		+28	dBm
Supply voltage, measured at pin of package (Note 2)	VCC1, VCC2, VCC3,		5.5	V
	VC_BIAS		3.8	V
	PA_EN			
Total supply current (I _{CC} + I _{BIAS} + I _{REF})	I _{CC_TOTAL}		1200	mA
Storage temperature	T _{ST}	-55	+125	°C
Junction temperature	T _J		+150	°C
Thermal resistance	Θ _{JC}	23	28	°C/W

Note 1: Exposure to maximum rating conditions for extended periods may reduce device reliability. There is no damage to device with only one parameter set at the limit and all other parameters set at or below their nominal value. Exceeding any of the limits listed here may result in permanent damage to the device.

Note 2: Evaluation Board supply voltage levels can be different. Refer to the Evaluation Board schematic diagram in Figure 21.

CAUTION: Although this device is designed to be as robust as possible, Electrostatic Discharge (ESD) can damage this device. This device must be protected at all times from ESD. Static charges may easily produce potentials of several kilovolts on the human body or equipment, which can discharge without detection. Industry-standard ESD precautions should be used at all times.

Table 3. SKY65137-11 Recommended Operating Conditions

Parameter	Symbol	Minimum	Typical	Maximum	Units
Frequency range	f	4.9		5.9	GHz
RF output power	P _{OUT}		+24		dBm
Supply voltage, measured at pin of package (Note 1)	VCC1, VCC2, VCC3, VC_BIAS	4.5	5.0	5.5	V
Power shutdown enable voltage @ PA_EN		2.5	3.0	3.6	V
Case operating temperature	T _c	-40		+85	°C

Note 1: Evaluation Board supply voltage levels can be different. Refer to the Evaluation Board schematic diagram in Figure 21.

Table 4. SKY65137-11 Electrical Specifications (1 of 2) (Note 1)

(VCC1 = VCC2 = VCC3 = VC_BIAS = 5 V, PA_EN = 3.3 V Static, T_c = +25 °C, Test Frequency = 5.75 GHz unless otherwise noted)

Parameter	Symbol	Test Condition	Min	Typical	Max	Units
<i>Using Continuous Wave Input Signals</i>						
Small signal gain	IS21I	P _{IN} = -30 dBm	24.5	26		dB
Gain flatness over band		From 5.6 to 5.9 GHz		1	2	dB
Output power @ 1 dB compression	P1dB		+31	+32		dBm
Quiescent Current	I _Q	No RF input		420	485	mA
Input return loss	IS11I	P _{IN} = -30 dBm			-10	dB
Detector voltage	V _{DET}	P _{OUT} = +24 dBm	0.50	0.60	0.70	V
		P _{OUT} = 0 dBm	0.10	0.15	0.20	V
Power added efficiency @ P1dB	PAE	@ P1dB	26	29		%
Shutdown mode current draw				2.0	2.5	μA
Power-up time	T _{UP}			500		ns
Power-down time	T _{DOWN}			50		ns

Table 4. SKY65137-11 Electrical Specifications (1 of 2) (Note 1)

(VCC1 = VCC2 = VCC3 = VC_BIAS = 5 V, PA_EN = 3.3 V Static, Tc = +25 °C, Test Frequency = 5.75 GHz, Unless Otherwise Noted)

Parameter	Symbol	Test Condition	Min	Typical	Max	Units
<i>Using IEEE802.11a Orthogonal Frequency Division Multiplexing Input Signal, Data Rate = 54 Mbps</i>						
Total supply current	I _{CC_TOTAL}	P _{OUT} = +24 dBm		490	570	mA
EVM @ P _{OUT} = +24 dBm	P _{OUT_EVM}			+2.0	+2.5	dBm
Static ruggedness		PA_EN static, 10:1 VSWR, P _{IN} = +10 dBm, 64 QAM input signal		Pass, all phases		–
Dynamic ruggedness		PA_EN pulsed, 4:1 VSWR, P _{IN} = +1 dBm, 64 QAM input signal		Pass, all phases		–

Note 1: Performance is guaranteed only under the conditions listed in this Table.

Typical Performance Characteristics

(VCC1 = VCC2 = VCC3 = VC_BIAS = 5 V, PA_EN = 3.3 V Static, Tc = +25 °C, Test Frequency = 5.75 GHz, Unless Otherwise Noted)

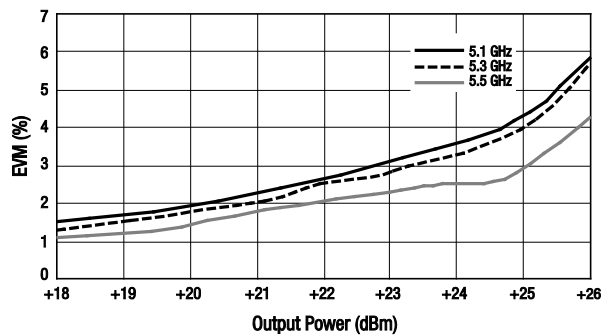

Figure 3. Low Band EVM vs Output Power

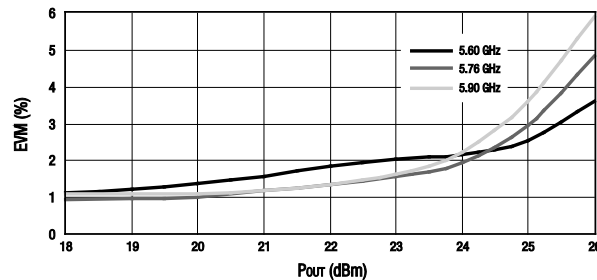

Figure 4. High Band EVM vs Output Power

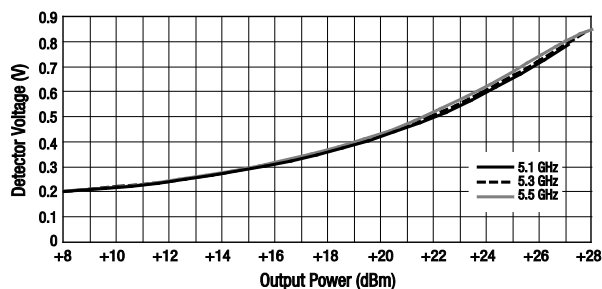

Figure 5. Low Band Detector Voltage vs Output Power

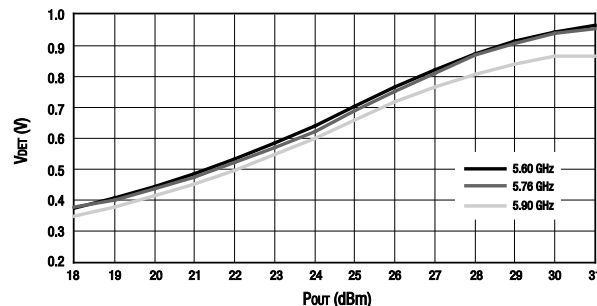

Figure 6. High Band Detector Voltage vs Output Power

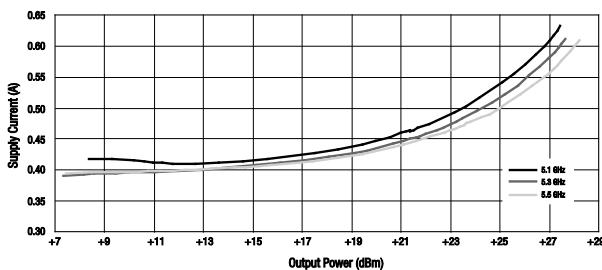

Figure 7. Supply Current vs Output Power, Modulated Input

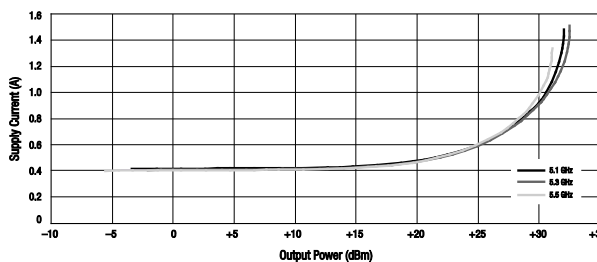

Figure 8. Supply Current vs Output Power, CW Input

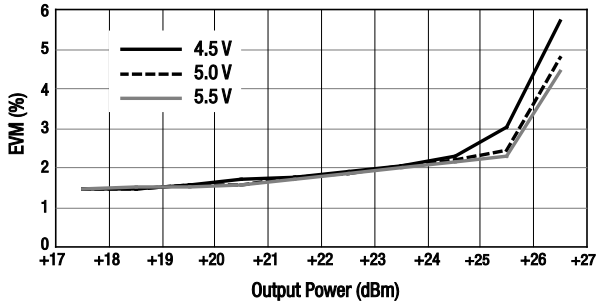

Figure 9. EVM vs Output Power Over Voltage

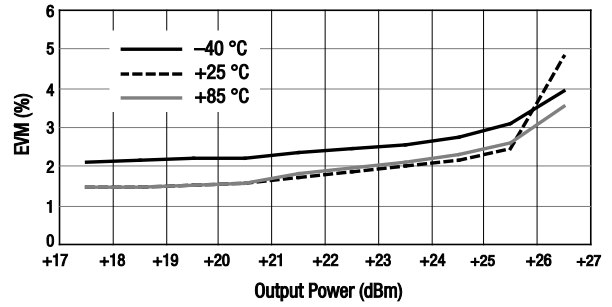

Figure 10. EVM vs Output Power Over Temperature

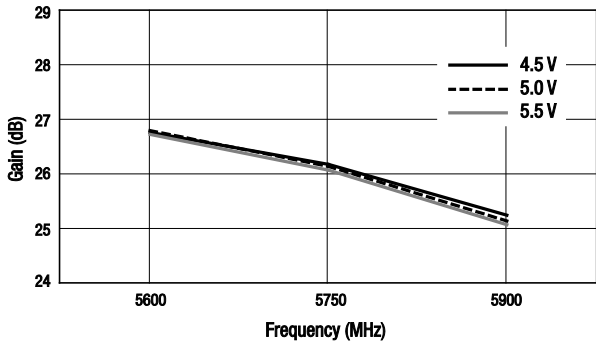

Figure 11. Small Signal Gain vs Frequency Over Voltage

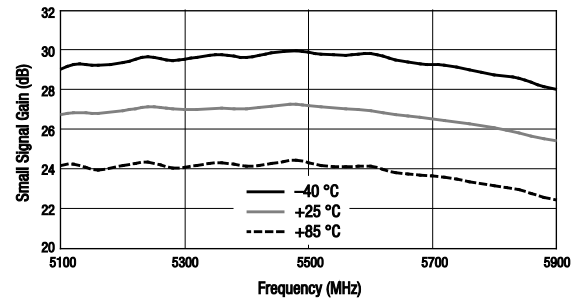

Figure 12. Small Signal Gain vs Frequency Over Temperature

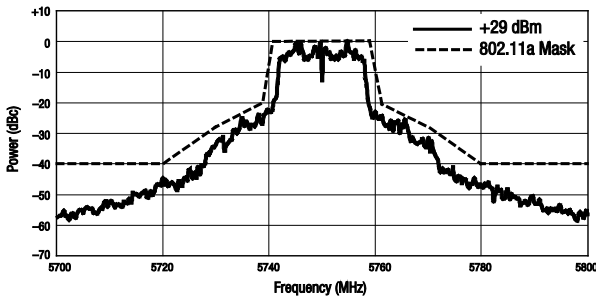

Figure 13. Typical Spectral Response With 802.11a 65-QAM OFDM Signal Over Output Power Level

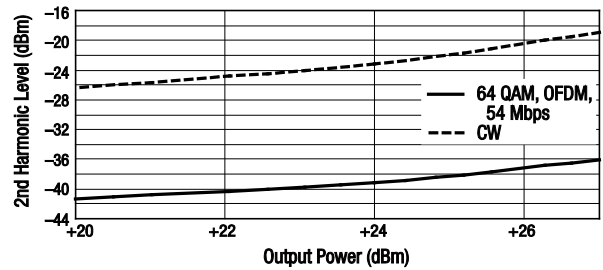

Figure 14. Second Harmonic vs Output Power

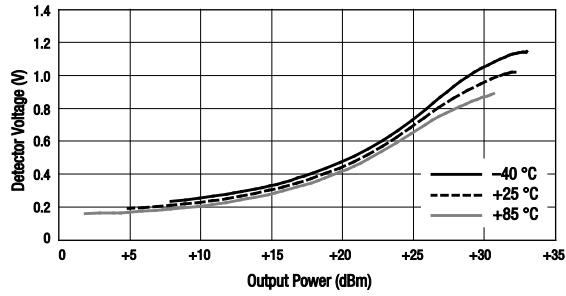

Figure 15. Detector Voltage vs Output Power Over Temperature

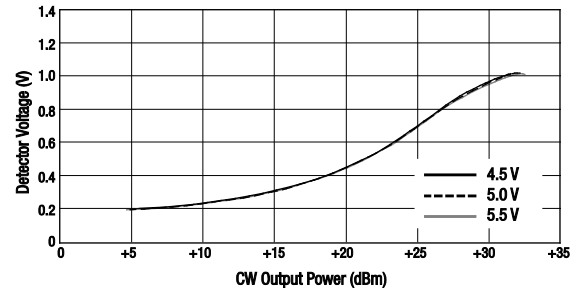

Figure 16. Detector Voltage vs Output Power Over Voltage

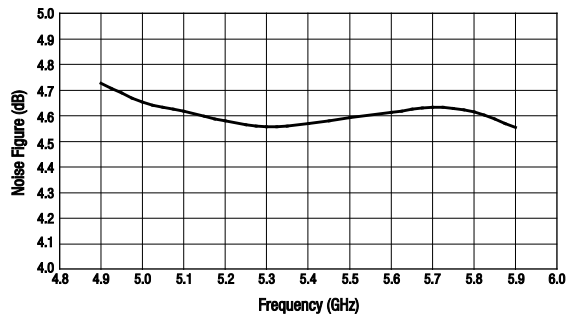

Figure 17. Noise Figure vs Frequency

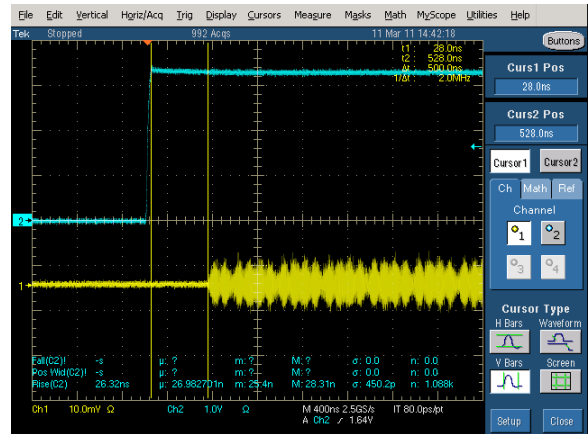

Figure 18. Start-Up Time

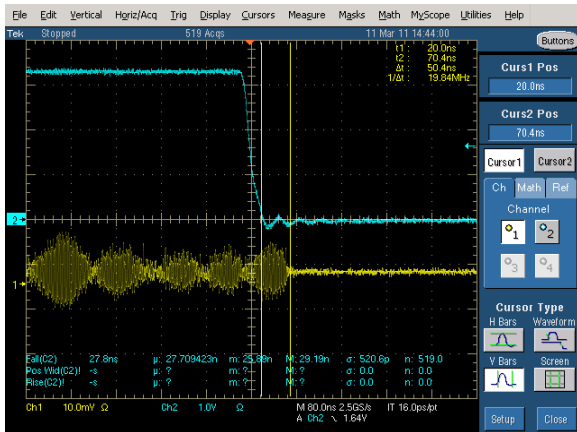

Figure 19. Power-Down Time

Evaluation Board Description

The SKY65137-11 Evaluation Board is used to test the performance of the SKY65137-11 WLAN PA. An assembly drawing for the Evaluation Board is shown in Figure 20 and the layer detail is provided in Figure 21. Layer detail physical characteristics are noted in Figure 22. A schematic diagram of the SKY65137-11 Evaluation Board is shown in Figure 23.

Circuit Design Considerations

The following design considerations are general in nature and must be followed regardless of final use or configuration

1. Paths to ground should be made as short as possible.
2. The ground pad of the SKY65137-11 has special electrical and thermal grounding requirements. This pad is the main thermal conduit for heat dissipation. Since the circuit board acts as the heat sink, it must shunt as much heat as possible from the device. Therefore, design the connection to the ground pad to dissipate the maximum wattage produced by the circuit board. Multiple vias to the grounding layer are required.
3. Bypass capacitors should be used on the DC supply lines. The Vcc lines may be connected after the RF bypass and decoupling capacitors to provide better isolation between each Vcc line. Refer to Figure 23 for further details.
4. The RF lines should be well separated from each other with solid ground in between traces to maximize input-to-output isolation.

NOTE: A poor connection between the slug and ground increases junction temperature (T_j), which reduces the lifetime of the device. Refer to the Skyworks Application Note, "PCB Design Guidelines for High Power Dissipation Packages" (document number 201211) for further information.

Evaluation Board Test Procedure

- Step 1: Connect a +5 V supply to the VCC1, VCC2, VCC3, and VC_BIAS pins. Connect the PA_ENB pin to a separate supply. If available, enable the current limiting function of the power supply to 1000 mA.
- Step 2: If desired, connect a voltage meter to the V_DET pin.

Step 3: Connect a signal generator to the RF signal input port. Set it to the desired RF frequency at a power level of -15 dBm or less to the Evaluation Board. **DO NOT** enable the RF signal.

Step 4: Connect a spectrum analyzer or vector signal analyzer to the RF signal output port. Add attenuation as needed to protect the analyzer.

Step 5: On startup, turn on the VCC1, VCC2, VCC3, and VC_BIAS lines first. Then turn on the PA_ENB line. Finally, turn on the RF input. Make sure to keep the initial input power to the PA at -20 dBm and gradually increase to the desired output power level.

Step 6: Take measurements.

Step 7: On power down, turn off the RF input first. Then turn off the PA_ENB line. Finally, turn off the VCC1, VCC2, VCC3, and VC_BIAS lines.

Package Dimensions

The PCB layout footprint for the SKY65137-11 is provided in Figure 22. Package dimensions for the 20-pin MCM are shown in Figure 23, and tape and reel dimensions are provided in Figure 24.

Package and Handling Information

Since the device package is sensitive to moisture absorption, it is baked and vacuum packed before shipping. Instructions on the shipping container label regarding exposure to moisture after the container seal is broken must be followed. Otherwise, problems related to moisture absorption may occur when the part is subjected to high temperature during solder assembly.

The SKY65137-11 is rated to Moisture Sensitivity Level 3 (MSL3) at 260 °C. It can be used for lead or lead-free soldering. For additional information, refer to Skyworks Application Note, *PCB Design and SMT Assembly/Rework Guidelines for MCM-L Packages*, document number 101752.

Care must be taken when attaching this product, whether it is done manually or in a production solder reflow environment. Production quantities of this product are shipped in a standard tape and reel format.

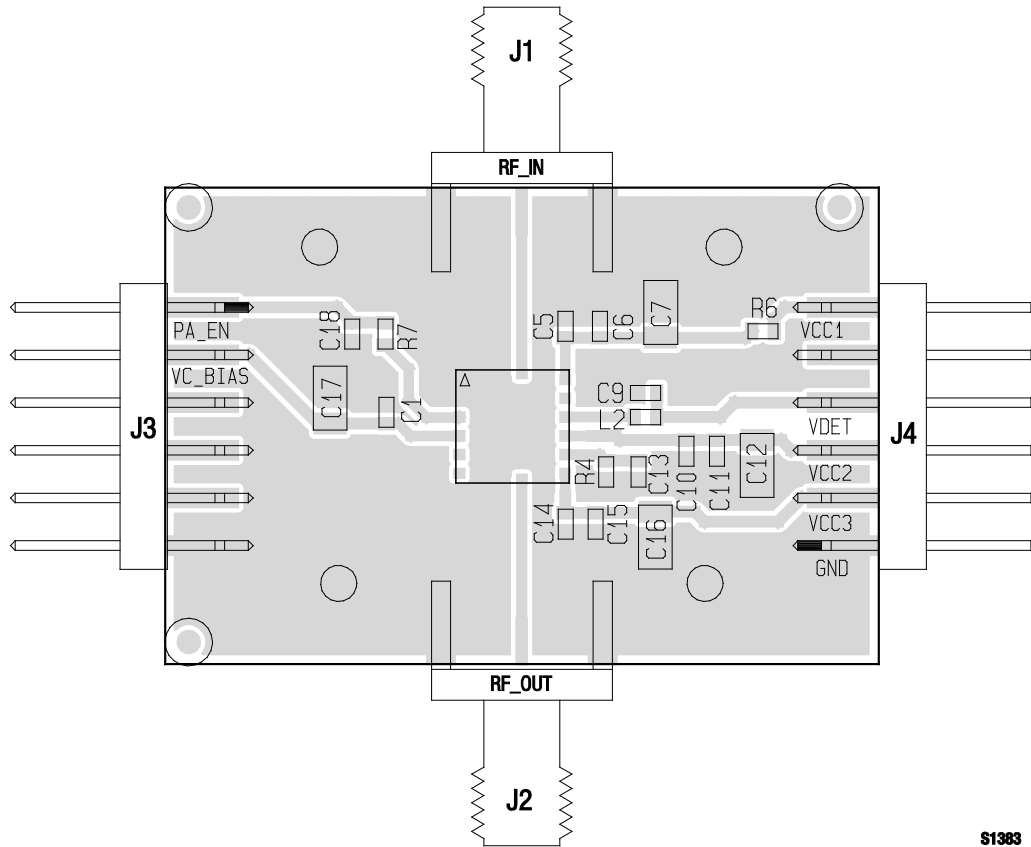

S1383

Figure 20. Evaluation Board Assembly Drawing

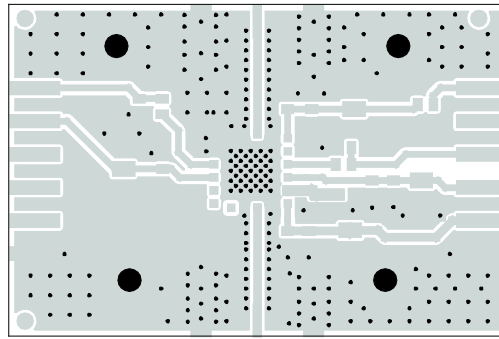

Layer 1: Top – Metal

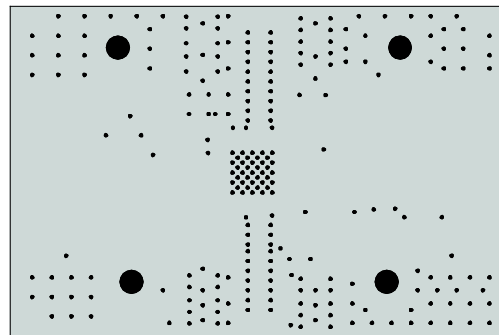

Layer 2: Ground

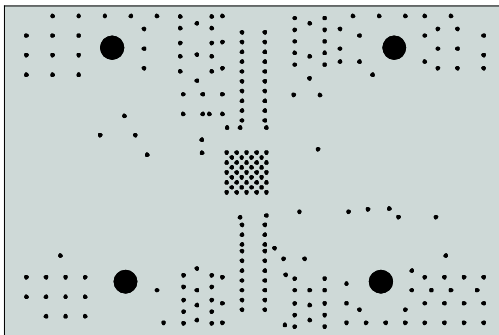

Layer 3: Ground Plane

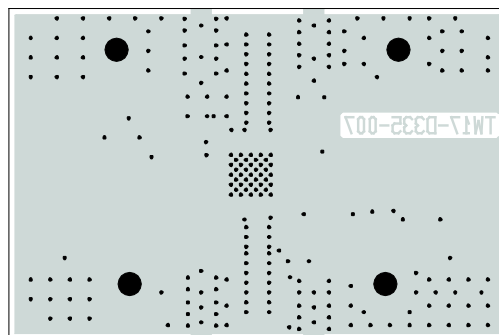

Layer 4: Solid Ground Plane

S1770

Figure 21. SKY65137-11 Evaluation Board Layer Detail

Cross Section	Name	Thickness (mm)	Material	ϵ_r
	Pri	0.036	Cu-1 oz.	-
	Die1	0.305	Rogers 4003-12	3.38
	L2	0.036	Cu-1 oz.	-
	Die2	0.102	FR4-4	4.35
	L3	0.036	Cu-1 oz.	-
	Die3	0.305	FR4-12	4.35
	Sec	0.036	Cu-1 oz.	-

Note: Vias are copper-filled

s2063

Figure 22. Evaluation Board Layer Detail Physical Characteristics

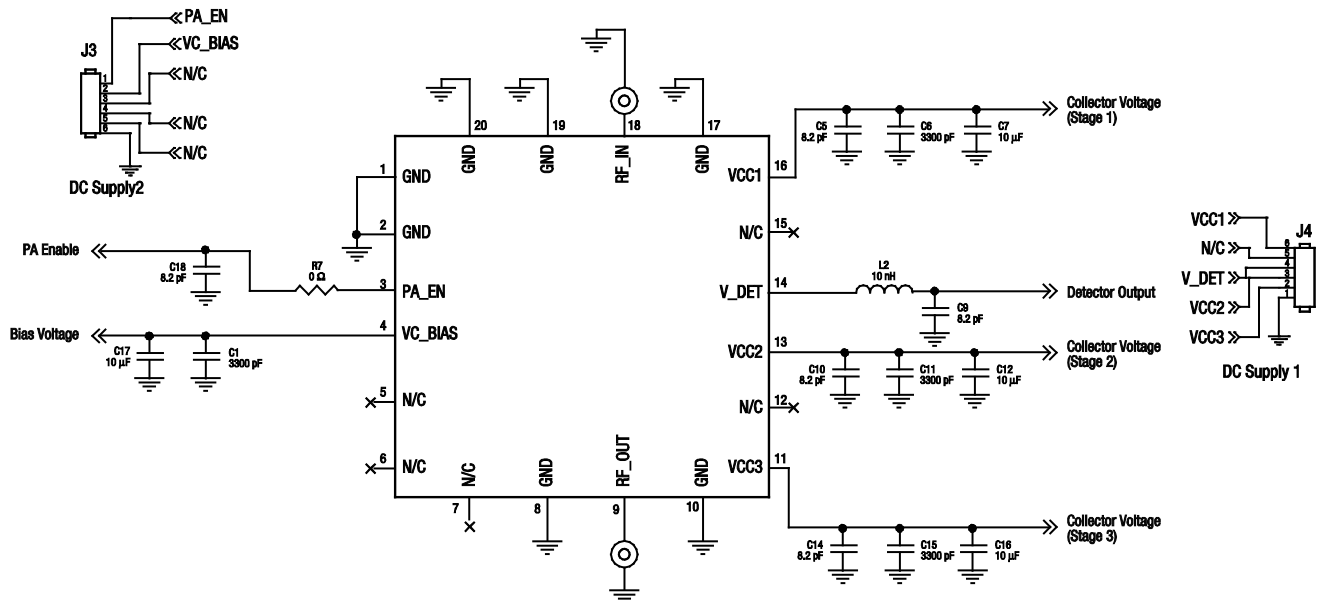

Note: Some component labels may be different than the corresponding component symbol shown here. Component values, however, are accurate as of the date of this Data Sheet.

S1243

Figure 23. SKY65137-11 Evaluation Board Schematic

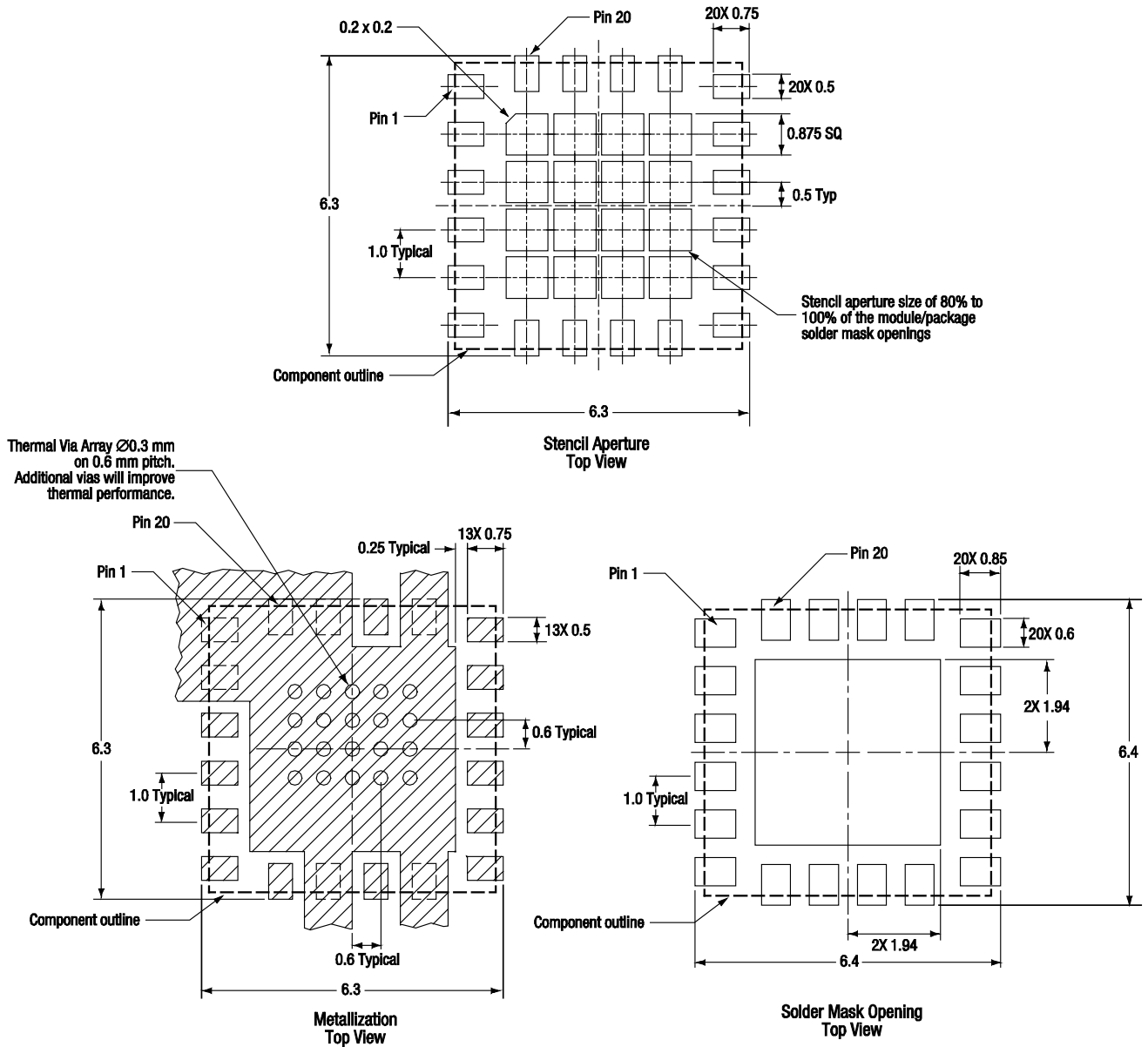

All measurements are in millimeters

Note: Thermal vias should be tented and filled with solder mask. 30 to 35 μ m Cu plating recommended.

S1248

Figure 24. PCB Layout Footprint For The SKY65137-11

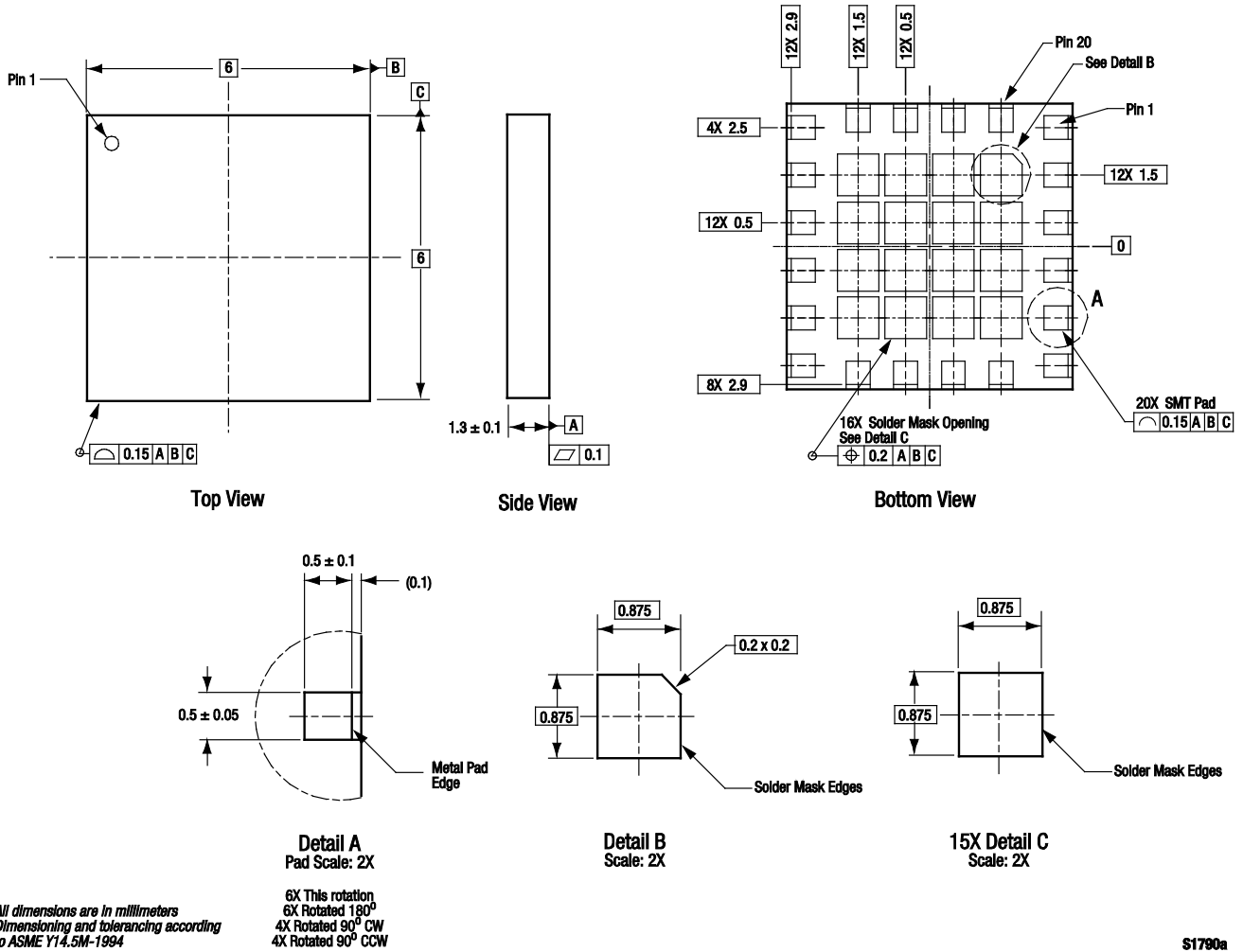

S1790a

Figure 25. SKY65137-11 20-Pin MCM Package Dimensions

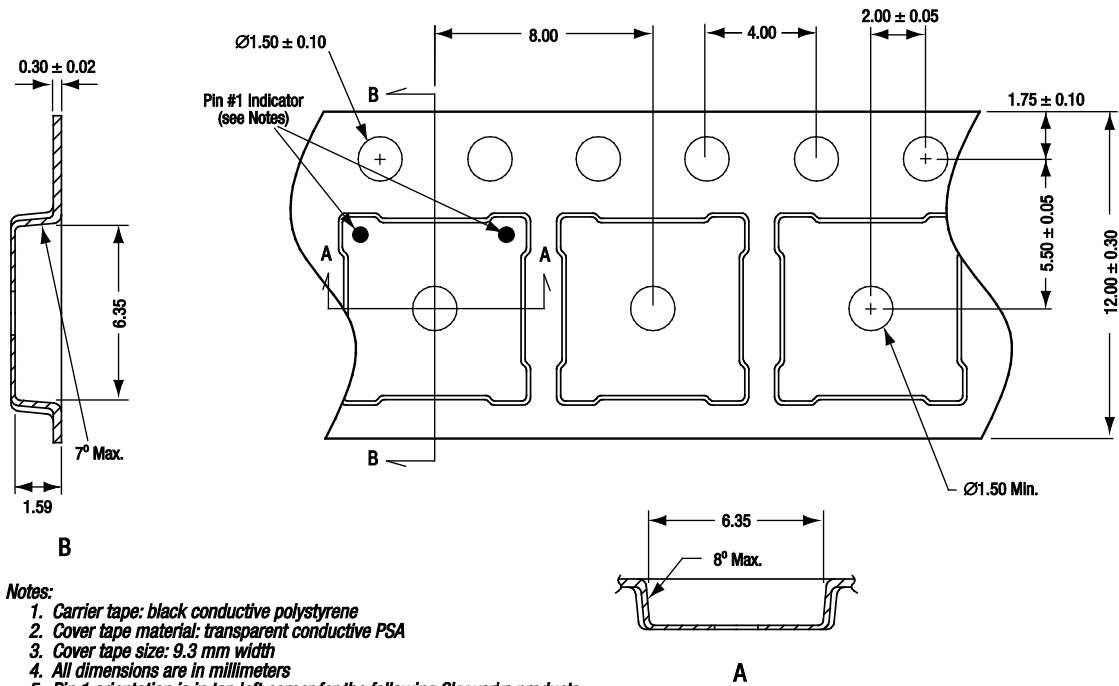

Notes:

1. Carrier tape: black conductive polystyrene
2. Cover tape material: transparent conductive PSA
3. Cover tape size: 9.3 mm width
4. All dimensions are in millimeters
5. Pin 1 orientation is in top left corner for the following Skyworks products:

SKY73022-21, -31
 SKY73023-21, -31

For all other 6 x 6 mm MCM/RFLGA products, pin 1 orientation is in top right corner.

S1183

Figure 26. SKY65137-11 20-Pin MCM Tape and Reel Dimensions

Ordering Information

Model Name	Manufacturing Part Number	Evaluation Board Part Number
SKY65137-11 WLAN Power Amplifier	SKY65137-11	TW17-D335-007

Copyright © 2008, 2009, 2010, 2011 Skyworks Solutions, Inc. All Rights Reserved.

Information in this document is provided in connection with Skyworks Solutions, Inc. ("Skyworks") products or services. These materials, including the information contained herein, are provided by Skyworks as a service to its customers and may be used for informational purposes only by the customer. Skyworks assumes no responsibility for errors or omissions in these materials or the information contained herein. Skyworks may change its documentation, products, services, specifications or product descriptions at any time, without notice. Skyworks makes no commitment to update the materials or information and shall have no responsibility whatsoever for conflicts, incompatibilities, or other difficulties arising from any future changes.

No license, whether express, implied, by estoppel or otherwise, is granted to any intellectual property rights by this document. Skyworks assumes no liability for any materials, products or information provided hereunder, including the sale, distribution, reproduction or use of Skyworks products, information or materials, except as may be provided in Skyworks Terms and Conditions of Sale.

THE MATERIALS, PRODUCTS AND INFORMATION ARE PROVIDED "AS IS" WITHOUT WARRANTY OF ANY KIND, WHETHER EXPRESS, IMPLIED, STATUTORY, OR OTHERWISE, INCLUDING FITNESS FOR A PARTICULAR PURPOSE OR USE, MERCHANTABILITY, PERFORMANCE, QUALITY OR NON-INFRINGEMENT OF ANY INTELLECTUAL PROPERTY RIGHT; ALL SUCH WARRANTIES ARE HEREBY EXPRESSLY DISCLAIMED. SKYWORKS DOES NOT WARRANT THE ACCURACY OR COMPLETENESS OF THE INFORMATION, TEXT, GRAPHICS OR OTHER ITEMS CONTAINED WITHIN THESE MATERIALS. SKYWORKS SHALL NOT BE LIABLE FOR ANY DAMAGES, INCLUDING BUT NOT LIMITED TO ANY SPECIAL, INDIRECT, INCIDENTAL, STATUTORY, OR CONSEQUENTIAL DAMAGES, INCLUDING WITHOUT LIMITATION, LOST REVENUES OR LOST PROFITS THAT MAY RESULT FROM THE USE OF THE MATERIALS OR INFORMATION, WHETHER OR NOT THE RECIPIENT OF MATERIALS HAS BEEN ADVISED OF THE POSSIBILITY OF SUCH DAMAGE.

Skyworks products are not intended for use in medical, lifesaving or life-sustaining applications, or other equipment in which the failure of the Skyworks products could lead to personal injury, death, physical or environmental damage. Skyworks customers using or selling Skyworks products for use in such applications do so at their own risk and agree to fully indemnify Skyworks for any damages resulting from such improper use or sale.

Customers are responsible for their products and applications using Skyworks products, which may deviate from published specifications as a result of design defects, errors, or operation of products outside of published parameters or design specifications. Customers should include design and operating safeguards to minimize these and other risks. Skyworks assumes no liability for applications assistance, customer product design, or damage to any equipment resulting from the use of Skyworks products outside of stated published specifications or parameters.

Skyworks, the Skyworks symbol, and "Breakthrough Simplicity" are trademarks or registered trademarks of Skyworks Solutions, Inc., in the United States and other countries. Third-party brands and names are for identification purposes only, and are the property of their respective owners. Additional information, including relevant terms and conditions, posted at www.skyworksinc.com, are incorporated by reference.