

- 3" x 5" x 1.38" Package, fits 1U application
- Up to 275 W of AC-DC Power
- Universal Input 90-264 Vac
- Class I Input
- Standby and Fan output voltages
- Forced Current Share
- Inhibit, Power Fail, Output OK signals
- Approved to EN/IEC/UL60950 2<sup>nd</sup> Edition
- Efficiency 92% typical



## Description

A Superior performance 275 Watts AC to DC power supply designed for industrial and ITE applications. Feature rich and highly efficient CINT1275 product family with active current share for redundant applications can easily fit in 1U chassis and provides 180 Watts for convection or 275 Watts with moving air. Input & output monitoring alarms plus isolated 12V/1A fan output and 5V standby voltage are among other standard offering of CINT1275 family. All 5 models are CE marked to low voltage directive and approved to ITE standards of EN60950, 2<sup>nd</sup> edition.

## Model Number Key

**CINT 1 275 X 12 0X K 01**

Model	"01" = Standard. "02" and higher indicates a modified
Input Connector:	"K" = Class I
Output Connector:	"0X" = X-pin header. Other options available, contact
Output Voltage:	"12" = 12Vdc, "15" = 15Vdc, "18" = 18Vdc, "24" = 24Vdc,
Model	"A" = First Generation
Output Power:	"275" = 275 Watts
# of Outputs	"1" = Single Output
Product Family :	"C" = Non-Medical, "I" = Internal, "NT" = New

## Output Parameters

Model Number	Volts (V)	Output Current w/airflow (1)	Output Current Convection	Total Regulation	Max. Ripple & Noise(2) (mV)	OVP Threshold
CINT1275A1214K01	12 V	21.83A	15.0 A	±3%	120	14.0 ± 1.1V
CINT1275A1514K01	15 V	18.30A	12.0 A	±3%	150	19.5 ± 1.5V
CINT1275A2414K01	24 V	10.92A	7.5 A	±3%	240	28.0 ± 2.5V
CINT1275A4814K01	48 V	5.46A	3.75 A	±3%	480	55.0 ± 4.0V
CINT1275A5614K01	56V(3)	4.68A	3.21 A	±3%	560	59.0 ± 1.0V

### Notes:

1. 200 lfm forced air cooling required for non-convection ratings.
2. Measured with noise probe directly across output terminals, and load terminated with 0.1µF ceramic and 10µF low ESR capacitors.
3. No output adjustment

## Specifications

All Specifications are typical at nominal input, full load at 25°C unless otherwise stated

<b>AC Input</b>	100-240Vac +/- 10%, 47-63 Hz single phase 120-370 Vdc	<b>Turn On Time</b>	Less than 2 sec. @115Vac (inversely proportional to input voltage and thermistor temperature)
<b>Input Current</b>	115Vac: 3A, 230Vac: 1.5A, 3.7A max at 90Vac	<b>Hold-up Time</b>	>16ms at 250W, 120Vac/60 Hz
<b>Inrush Current</b>	264Vac, cold start: will not exceed 50A	<b>Over Temperature Protection</b>	Sensing transformer temperature, 135°C (55C ambient temperature at full load), latching type.
<b>Input Fuses</b>	F1, F2: 5A, 275VAC	<b>Overload Protection</b>	120 to 150% of rating, cycling type
<b>Earth Leakage Current</b>	<750µA@264Vac, 60Hz, NC	<b>Short Circuit Protection</b>	Cycling type, auto recovery
<b>Isolation</b>	Input-Output: 4000Vac Input-Ground: 1800Vac, Output-Ground: 700Vdc	<b>Switching Frequency</b>	56kHz typical
<b>Efficiency</b>	92% typical	<b>Overvoltage Protection</b>	OVP latch at 110 to 130% of output voltage
<b>Output Power</b>	275W continuous, with 200 lfm airflow, 180W convection cooled – See chart for specific model ratings	<b>Operating Temperature</b>	Start up at -40C with -10 to +70°C Range Derate output power to 50% between 50 and 70°C
<b>Transient Response</b>	500µs typ. for return to within 0.5% of nominal, 50% load step. $\Delta i/\Delta t < 0.2A/\mu S$ . Max Volt Deviation = 3%	<b>Vibration</b>	Operating: 0.003g <sup>2</sup> /Hz, 1.5g <sub>rms</sub> overall, 3 axes, 10 min/axis Non-Operating: 0.026 g <sup>2</sup> /Hz, 5.0g <sub>rms</sub> overall, 3 axes, 1 hr/axis
<b>Ripple and Noise</b>	0.5%RMS, 1% pk-pk	<b>Storage Temperature</b>	-40 to +85°C
<b>Output Voltage</b>	See chart	<b>Operating Altitude</b>	-500 to 10,000 ft.
<b>Voltage Adjustability</b>	+/-5% from nominal	<b>Non-operating Altitude</b>	-500 to 40,000 ft.
<b>Minimum Load</b>	Not required	<b>Relative Humidity</b>	5% to 95%, non-condensing
<b>Total Regulation</b>	+/- 3% combined line, load, and initial setting	<b>Shock</b>	Operating: Half-sine, 20 g <sub>pk</sub> , 10 ms, 3 axes, 6 shocks total Non-Operating: Half-sine, 40 g <sub>pk</sub> , 10 ms, 3 axes, 6 shocks total
<b>Standby Voltage</b>	5V / 200 mA with +/-5%regulation	<b>Medical Safety Standards</b>	EN/CSA/UL/IEC 60601-1, 3rd Edition Type B
<b>Fan Output</b>	12V / 1 A with +/-10% regulation	<b>ITE Safety Standards</b>	EN/CSA/UL/IEC 60950-1, 2nd Edition
<b>Current Share</b>	Forced share pin, up to 5 supplies	<b>Dimensions</b>	W: 3.0" x L: 5.0" x H: 1.38" (from bottom of the board)

## EMI/EMC Compliance

<b>Conducted Emissions</b>	EN55011/22 Class B, FCC Part 15, Class B,
<b>Radiated Emissions</b>	EN55011/22 Class A, FCC Part 15, Class A, 6 dB margin
<b>Static Discharge Immunity</b>	EN61000-4-2, 6kV Contact Discharge, 8kV air discharge
<b>Radiated RF Immunity</b>	EN61000-4-3, 3V/m.
<b>EFT/Burst Immunity</b>	EN61000-4-4, 2kV/5kHz
<b>Line Surge Immunity</b>	EN61000-4-5, 1kV differential, 2kV common-mode
<b>Conducted RF Immunity</b>	EN61000-4-6, 3Vrms
<b>Power Frequency Magnetic Field Immunity</b>	EN61000-4-8, 3A/m
<b>Voltage Dip Immunity</b>	EN61000-4-11, 100%, 10ms; 30%, 275ms; 60%, 100ms; Performance Criteria A, A, & A at 70% load.
<b>Line Harmonic Emissions</b>	EN61000-3-2, Class A, C & D

## Mechanical Drawing and Connector information

### Connectors and pin assignment

Connector	#	Pin assignment	Mating Connectors
Input	1	AC L	Molex 09-50-3031 (connector) PINS: 08-52-0072
	2	Empty	
	3	AC N	
Ground	1	FG	Molex 01-90020001
Main output	1	+V1	Molex 19141-0058/0063/0083
	2	RTN	
Fan output	1	12V Fan RTN	Molex 22-01-3027 PINS: 08-50-0114
	2	12V Fan +	
Signal	1	Remote sense +	Molex 90142-0010 (USA) PINS: 90119-2110 or Amp: 87977-3 PINS: 87309-8
	2	Common	
	3	Remote sense -	
	4	Current sharing	
	5	Remote Inhibit	
	6	Common	
	7	Power good	
	8	+5V SB	
	9	DC_OK	
	10	+5V SB RTN	

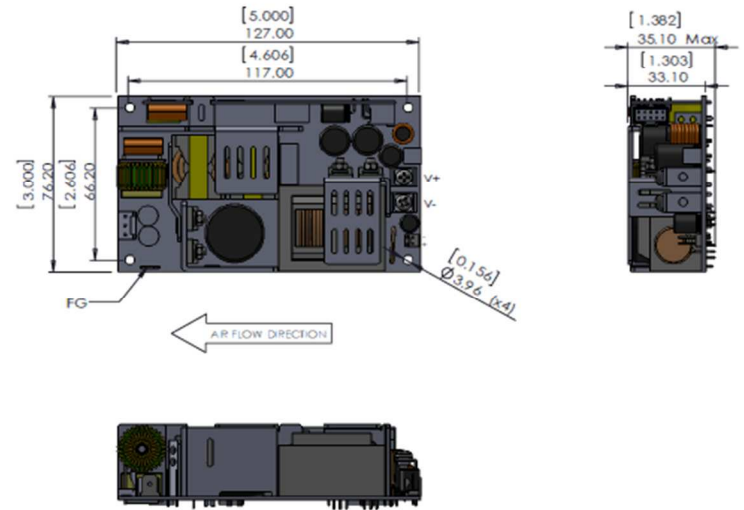

#### Notice

1. All dimensions in inches (mm), tolerance is  $\pm 0.02$ .
2. Mounting holes should be grounded for EMI purpose
3. FG is safety ground connection
4. This power supply requires mounting on metal standoffs 0.20" (5mm) in height.

## Auxiliary Signal Description and Functionality

The signals provided in J201 & J301 allow the system designer to monitor and control the output of the CINT1275A& MINT1275A& MINT1250A series power supply.

### Fan Output – J301:

J301 provides a 12V@1A output to support a system cooling fan. The fan output is always available when AC input is present and Inhibit disable.

### AC Power Failure/DC OK , Inhibit Signals and Current Sharing – J201:

#### 1. Power fail/DC OK

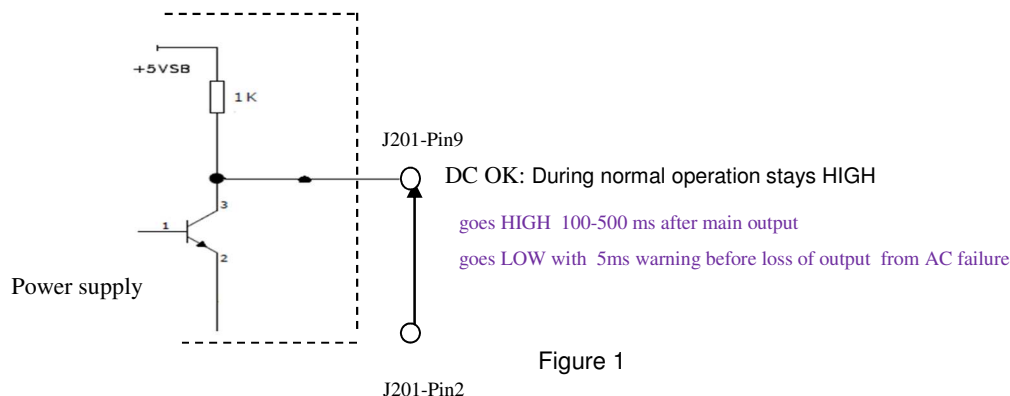

Figure 1

Because Power fail and DC OK have been combined to one pin, so system designer can use the signal monitor as below:

**DC OK:** when J201-Pin9 HIGH

**AC Power Fail:** when J201-Pin9 LOW

## 2. Inhibit

Remote inhibit control the output.  
J201 pin5 open-----on.  
J201 pin5 Low/ground-----off.

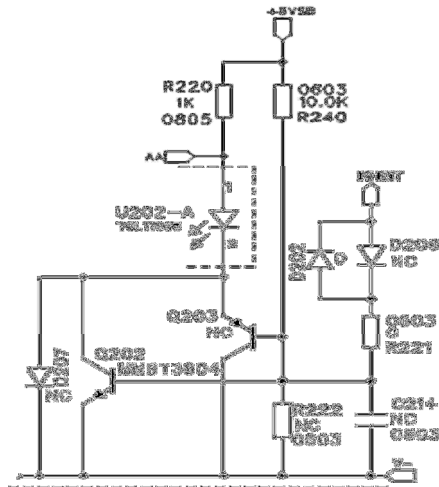

Figure 2

## 3. Current Sharing/Remote Sense

The outputs of N+1 (N=1,2,3...) models can be shared. It is shown in Figure3, one load-share controller is required for each model and circuits are identical when N+ 1 identical models are used.

Terminals J302 and J303 are connected to the Vo+ and Vo-, respectively, of the first power model. The Vo+ and Vo- correspond to the other models positive and negative output pins. The Vo+ connects to positive output bus to the load and Vo- connects the negative output bus to the load.

The J201 pin1 and pin3 connects to the S+ and S-, respectively, of the first power models. The S+ and S- correspond to the other models J201 pin1 and pin3. The S+ connects to positive output bus and S- connects to negative output bus.

### Remote Sense < 250mV drop compensation:

The J201 Pin4 connects to current sharing bus that it connects to other models J201 pin4.

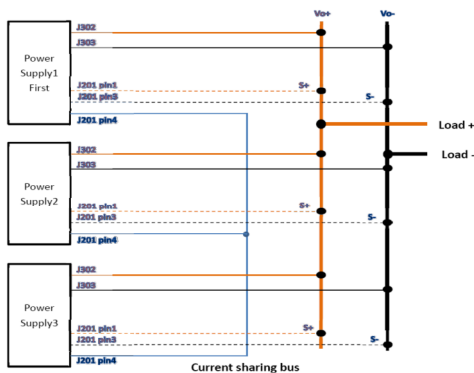

Figure 3

### Isolation Specifications

Parameter	Conditions/Description	Min	Nom	Max	Units
Insulation Safety Rating	Input/Ground			Basic	
	Input/Output			Reinforced	
	Output/Ground			n/a	
Electric Strength Test Voltage	Input/Ground	1800			VAC
	Input/Output	4000	-	-	VAC
	Output/Ground	700			VDC

### Input Specification

All specifications apply over specified input voltage, output load, and temperature range, unless otherwise noted.

Parameter	Conditions/Description	Min	Nom	Max	Units
Input Voltage		90	115/230	264	VAC
Turn-On Input Voltage	Ramping up		80		VAC
Turn-Off Input Voltage	Ramping down		75		VAC
Input Frequency		47	50/60	63	Hz
Inrush Current Limitation	264Vac, cold start	-	-	50	A
Power Factor	$V_{I \text{ nom}}, I_{O \text{ nom}}$	0.9	-	-	
Efficiency	$V_{I \text{ nom}}, I_{O \text{ nom}}$				
	CINT1275A1214K01				
	CINT1275A1514K01				
	CINT1275A2414K01				
	CINT1275A4814K01				
	CINT1275A5614K01	-	92%	-	%

### Output Specification

Parameter	Conditions/Description	Min	Nom	Max	Units
Output Voltage Setpoint Accuracy CINT1275A1214K01	$V_{i\ nom,}, I_{o1}$ @ ADC, $T_C = 25\ ^\circ C$	-3	-	3	% $V_o\ nom$
Output Voltage Setpoint Accuracy CINT1275A1514K01	$V_{i\ nom,}, I_{o1}$ @ ADC, $T_C = 25\ ^\circ C$	-3	-	3	% $V_o\ nom$
Output Voltage Setpoint Accuracy CINT1275A2414K01	$V_{i\ nom,}, I_{o1}$ @ ADC, $T_C = 25\ ^\circ C$	-3	-	3	% $V_o\ nom$
Output Voltage Setpoint Accuracy CINT1275A4814K01	$V_{i\ nom,}, I_{o1}$ @ ADC, $T_C = 25\ ^\circ C$	-3	-	3	% $V_o\ nom$
Output Voltage Setpoint Accuracy CINT1275A5614K01	$V_{i\ nom,}, I_{o1}$ @ ADC, $T_C = 25\ ^\circ C$	-3	-	3	% $V_o\ nom$
Output Current V1 Output Current V2	CINT1275A1214K01	0 0	15.0 -	21.83 1.0	ADC ADC
Output Current V1 Output Current V2	CINT1275A1514K01	0 0	12.0 -	17.47 1.0	ADC ADC
Output Current V1 Output Current V2	CINT1275A2414K01	0 0	7.5 -	10.92 1.0	ADC ADC
Output Current V1 Output Current V2	CINT1275A4814K01	0 0	3.75 -	5.46 1.0	ADC ADC
Output Current V1 Output Current V2	CINT1275A5614K01	0 0	3.21 -	4.68 1.0	ADC ADC
Static Line Regulation V1	$V_{i\ min-} - V_{i\ max}, V_{i\ nom}, 0-100\% I_{o\ nom}$	-1	-	1	% $V_o\ nom$
Static Load Regulation V1 (Droop Characteristic)	$V_{i\ min-} - V_{i\ max}, V_{i\ nom}, 0-100\% I_{o\ nom}$	-3	-	3	% $V_o\ nom$
Hold-Up Time	Starting at $V_i = 230\ VAC, P_o\ nom$	-	16	-	ms
Dynamic Load Regulation	Load change =50%, $di/dt = 0.2A/\mu S$ voltage deviation 3%	0		3	% $V_o\ nom$
Start-Up Time	$V_{i\ nom}, I_{o\ nom}$	0	-	2	S

### Protection

All specifications apply over specified input voltage, output load, and temperature range, unless otherwise noted.

Parameter	Conditions/Description	Min	Nom	Max	Units
Input Fuse	Not user accessible				
Input Transient Protection	2KV(CM) and 1KV(DM) surge			2	KV (CM)
Output	No-load and short circuit proof				Hiccup
	short circuit proof				Hiccup
	overload (latch style)				Hiccup
Overvoltage Protection	Latch style				Latch
Over temperature Protection	Automatic power shutdown at $T_C = 135\ C$				

## Characteristic Curves

### 1. Output Vs Temperature

180W convection cooled and 275W continuous with 200 LFM airflow, Derating output power to 50% at 70°C.

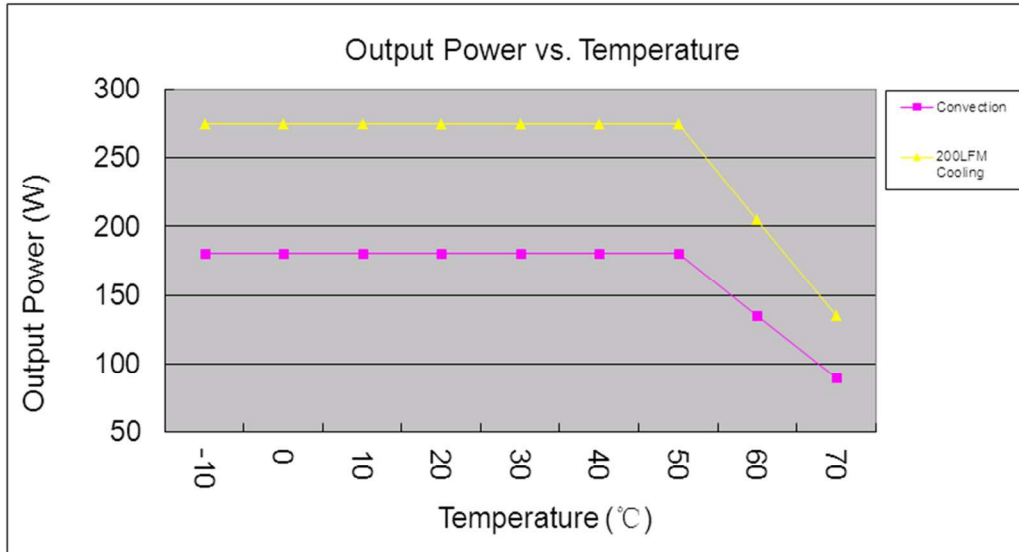

### 2. Efficiency Vs Loading

The high efficiency is achieved by using LLC technology with CCM mode PFC topology, and synchronous rectifiers on the output in all this family modes minimizing switching losses.

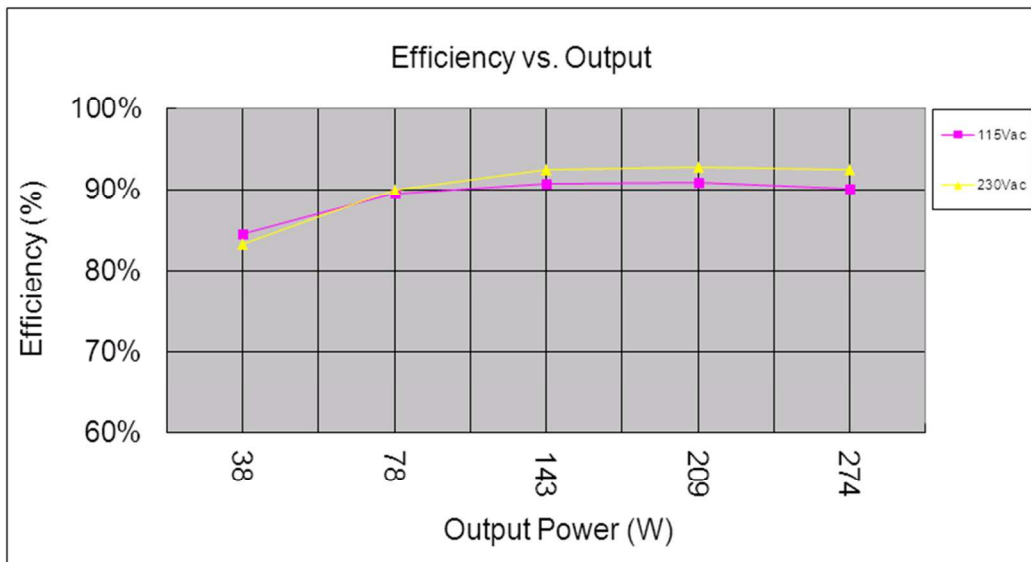

### 3. Ripple & Noise

To verify that the output ripple and noise does not exceed the level specified in the product specification. Measured using a scope probe socket with 0.1uF ceramic and a 10uF electrolysis capacitor connected in parallel across it, BW limit with 20MHz.

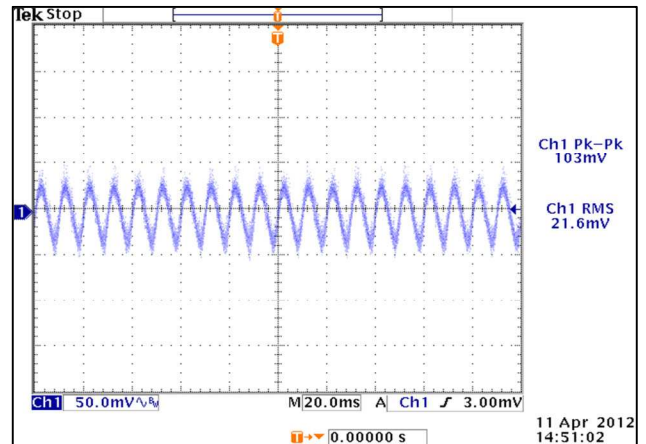
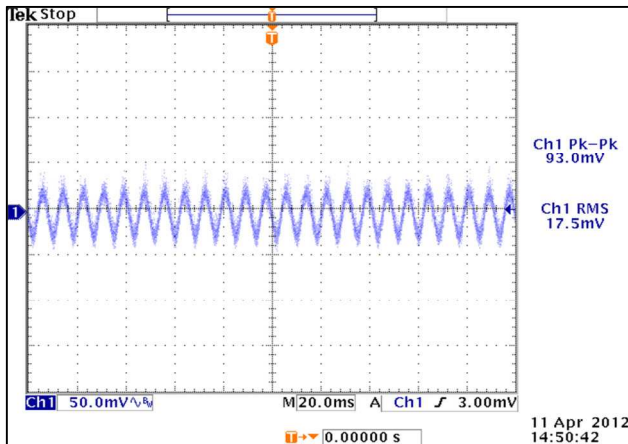

### 4. Output Transient Response

50% load step within the regulation limits of minimum and maximum load,  $di/dt < 0.2A/\mu\text{Sec}$ . Recovery time not specified as there is no laps in regulation with a 50% Load Step. Maximum voltage deviation is 3%, This test is performed on the MAIN OUTPUT ONLY.

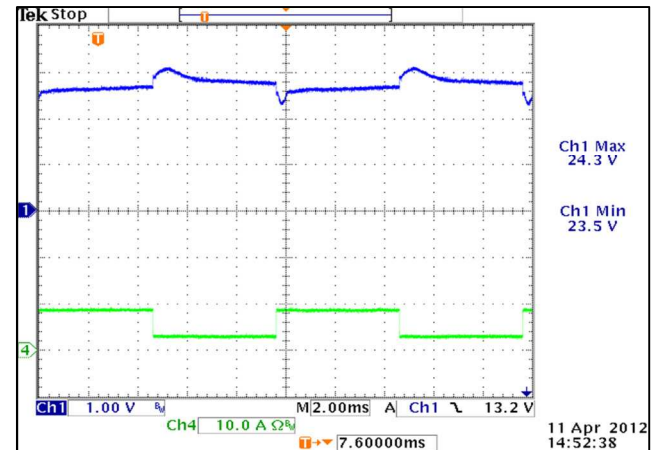
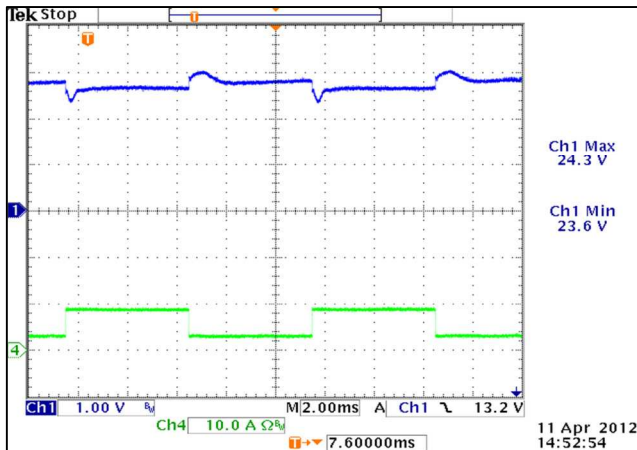



## 5. Output Overload Characteristic

Supply shall protect itself against Overload conditions. The Power Supply shall recover from Overload Conditions without operator intervention.

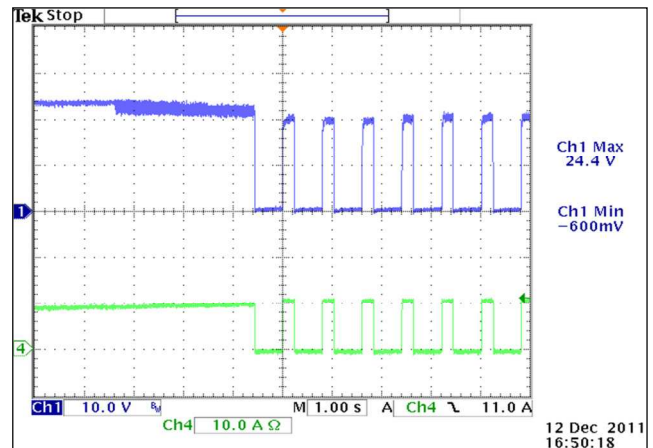
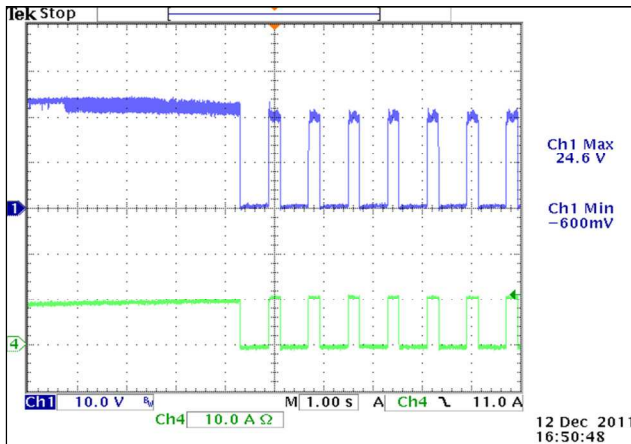

## 6. Output Overshoot

When supply is turned on, off or when the load is stepped 100% -- The Power Supply Overshoot / Undershoot shall not exceed minimum or maximum of output voltage regulation.

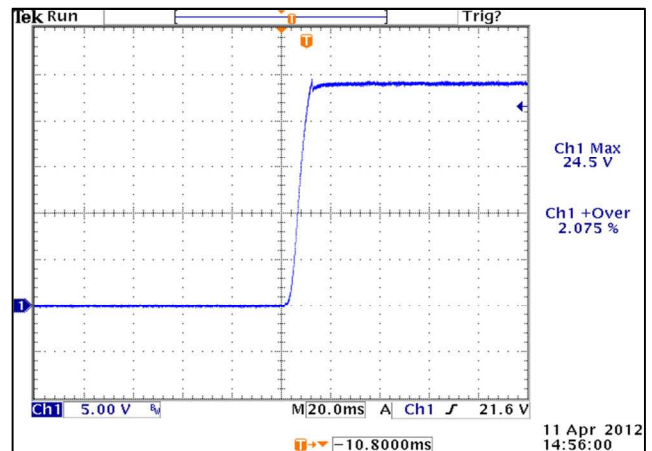
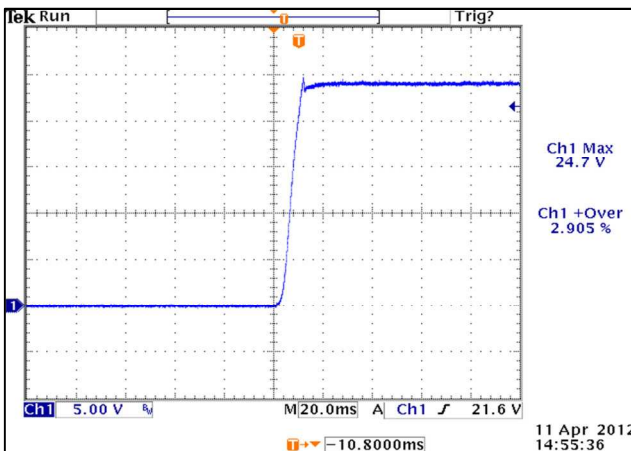

## 7. Standby Operation

The standby output is always available when AC input is present. It 5V/0.2A standby output.

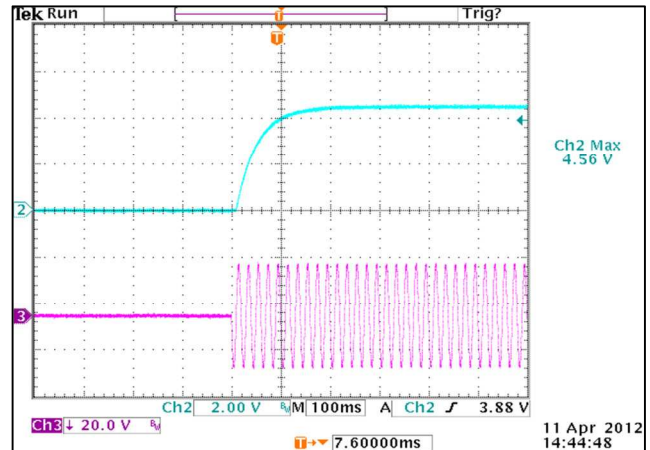
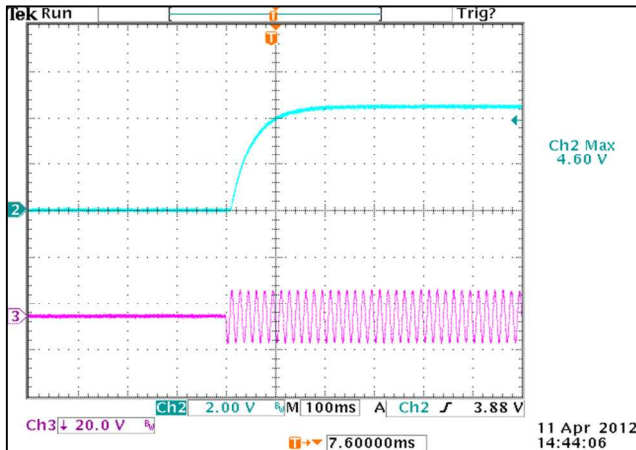

## 8. Current Share Operation

Power up at full Load and with 12V /1A load for Fan Power and 5V/0.2A load for standby, Make sure the output voltage of main output is in the range of  $\pm 1\%$  rating output voltage via adjusting the value of R326, Outputs of both power supplies were connected together and share the total set current. Measure the output current of each power supply (I1 & I2) and calculate the value of D according to below formula, D must be less than 10%.

$$D = 2 \left( \frac{I_1 - I_2}{I_1 + I_2} \right) \times 100\%$$

2 units in current share with load change from 10% to 100 %.( below data measured by 2 pcs 24V units)

Load Setting (% of Full Load)	Total Load (Amps)	Measured I1 (Amps)	Measured I2 (Amps)	D (%)
10%	2.28	1.11	1.17	5.3%
20%	4.56	2.18	2.38	8.8%
30%	6.89	3.32	3.56	7.0%
40%	9.18	4.46	4.72	5.7%
50%	11.47	5.59	5.88	5.1%
60%	13.78	6.72	7.05	4.8%
70%	16.08	7.91	8.17	3.2%
80%	18.39	9.05	9.34	3.2%
90%	20.69	10.18	10.51	3.2%
100%	22.93	11.30	11.63	2.9%