

**1.6A Linear Li-Ion Battery Charger in a 3x3 TDFN Package**

**General Description**

The AAT3698-1/-2 BatteryManager™ is a single-cell lithium-ion (Li-Ion)/Li-Polymer battery charger IC designed to operate from a USB port or AC adapter with an input voltage of up to 7.0V. For increased safety, the AAT3698-1/-2 also includes over-voltage input protection (OVP) up to 28V.

The AAT3698-1/-2 precisely regulates battery voltage for 4.2V Li-Ion/Polymer battery cells through a low  $R_{DS(ON)}$  switch. The charging current can be set by an external resistor up to 1.6A. If an over-voltage condition occurs from the input, the series switch quickly opens and a fault flag is activated, preventing damage to the battery and the charging circuitry.

Other fault conditions are monitored in real time. In case of an over-current, battery over-voltage, short circuit, or over-temperature failure, the device will automatically shut down, thus protecting the charging device, control system, and the battery under charge. A status monitoring output pin (STAT) is provided to indicate charging activity. This open drain output pin can be used to drive an external LED as a charging indicator.

The AAT3698-1/-2 also includes a 5.0V LDO linear regulator with over-voltage protection that can supply loads of up to 50mA.

The AAT3698-1/-2 is available in the Pb-free, thermally enhanced, space-saving 3x3mm TDFN33-14 package and is rated over the -40°C to +85°C temperature range.

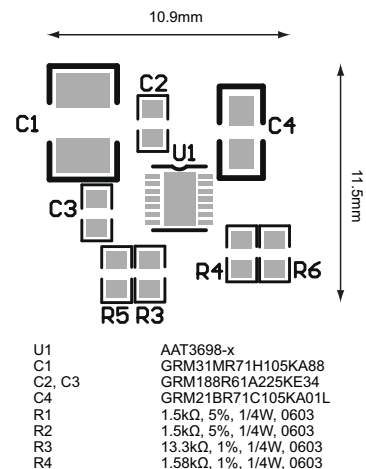
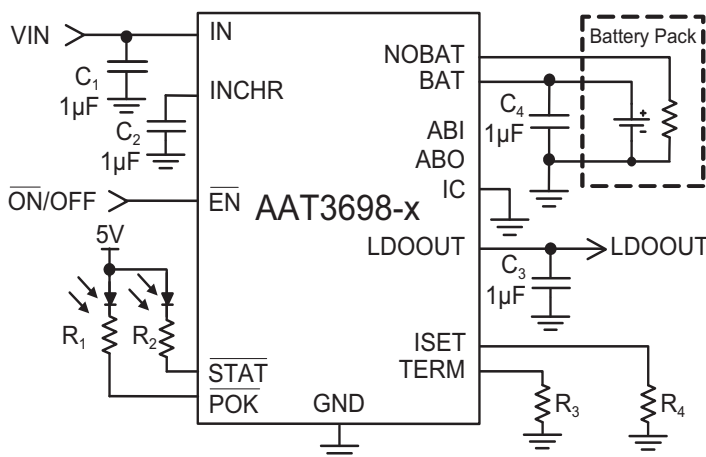
**Features**

- USB or AC Adapter System Power Charger
- 3.0V ~ 7.0V Input Voltage Range
- Fast Over-Voltage Protection Turn Off
- OVP Trip Threshold: 7.25V (typ)
- High Level of Integration with Internal:
  - Power Device
  - Reverse Current Blocking
  - Current Sensing
- 5V/50mA LDO Output
- Programmable Fast Charge Current from 50mA to 1.6A
- Programmable Charge Termination Current
- Charge Status Indicator
- Power OK Indicator
- Battery Absence Detection Input Pin
- Automatic Termination and Recharge Sequencing (AAT3698-1 Only)
- Automatic Trickle Charge For Battery Pre-Conditioning
- Emergency Thermal Shutdown Protection
- Digitally Controlled Thermal Loop Regulation
- Active Low Enable with Internal 200kΩ Pull-Down Resistor
- Output for Auto-Booting
- 14-pin 3x3mm TDFN Package

**Applications**

- Bluetooth™ Headsets, Headphones, Accessories
- Digital Still Cameras
- Mobile Telephones
- Personal Data Assistants (PDAs)
- MP3 Players
- Other Lithium-Ion/Polymer Battery-Powered Devices

**Typical Application**



# AAT3698

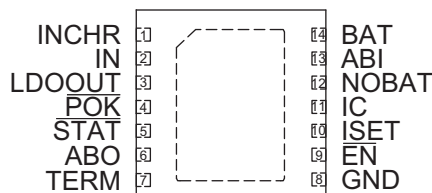
## 1.6A Linear Li-Ion Battery Charger in a 3x3 TDFN Package

### Pin Description

Pin #	Name	Type	Function
1	INCHR	I/O	OVP output switch and battery charger input; decouple to GND with 1μF capacitor.
2	IN	I	Input from USB port or adapter connector.
3	LDOOUT	O	5V/50mA LDO output through OVP device; bypass to GND with 1μF capacitor.
4	POK	O	Power OK flag pin; open drain, active low.
5	STAT	O	Charge status indicator pin; open drain, active low.
6	ABO	O	Auto booting output.
7	TERM	I	Connect the R <sub>TERM</sub> resistor between the TERM pin and ground to set the charge termination current. When the TERM pin is connected to INCHR, charge current termination level is set to 10% of the programmed fast charge current.
8	GND	I	Power ground.
9	EN	I	Enable pin, active low. Internally connected to ground through a 200kΩ pull-down resistor.
10	ISET	I	Connect R <sub>SET</sub> resistor to this pin to set charging current. Connect a 10kΩ resistor from this pin to the system to monitor this pin's voltage.
11	IC	I	Internally connected; connect this pin to ground.
12	NOBAT	I	No battery detection input. If the NOBAT pin is left unconnected, charging is disabled. Internally pulled to LDOOUT pin through a 1.6MΩ pull-up resistor.
13	ABI	I	Auto booting input. Internally connected to ground through a 200kΩ pull-down resistor.
14	BAT	O	Connect to Li-Ion battery.
EP			Exposed paddle; connect to ground.

### Pin Configuration

**TDFN33-14  
(Top View)**



**1.6A Linear Li-Ion Battery Charger in a 3x3 TDFN Package****Absolute Maximum Ratings<sup>1</sup>**

Symbol	Description	Value	Units
$V_{IN}$	IN continuous	-0.3 to 30	V
$V_P$	INCHR, EN, STATB, POK, ABI, NOBAT	-0.3 to 7.5	V
$V_N$	BAT, ISET, TERM, LODOUT, ABO, IC	-0.3 to $V_{INCHR} + 0.3$	V
$T_J$	Junction Temperature Range	-40 to 150	°C
$T_A$	Operating Temperature Range	-40 to 85	°C
$T_{LEAD}$	Maximum Soldering Temperature (at leads)	300	°C

**Thermal Information<sup>2</sup>**

Symbol	Description	Value	Units
$\theta_{JA}$	Maximum Thermal Resistance (TDFN33-14)	50	°C/W
$P_D$	Maximum Power Dissipation	2	W

1. Stresses above those listed in Absolute Maximum Ratings may cause permanent damage to the device. Functional operation at conditions other than the operating conditions specified is not implied. Only one Absolute Maximum Rating should be applied at any one time.

2. Mounted on an FR4 board.

**1.6A Linear Li-Ion Battery Charger in a 3x3 TDFN Package**

**Electrical Characteristics<sup>1</sup>**

$V_{IN} = 5V$ ,  $R_{SET} = 3.16k\Omega$ ,  $V_{ENB} = V_{NOBAT} = 0V$ ,  $C_{IN} = 1\mu F$ ,  $C_{INCHR} = 1\mu F$ ,  $C_{BAT} = 1\mu F$ ,  $C_{LDOOUT} = 1\mu F$ ,  $TERM = ABI = IC = open$ ,  $T_A = -40$  to  $+85^\circ C$ , unless otherwise noted. Typical values are at  $T_A = 25^\circ C$ .

Symbol	Description	Conditions	Min	Typ	Max	Units
<b>Operation</b>						
$V_{IN\_MAX}$	Input Over-Voltage Protection Range				28	V
$V_{IN}$	Normal Operating Input Voltage Range		3.0		7.0	V
$I_{OP}$	Operating Current	$V_{BAT} = 4.3V$ , $R_{SET} = 15.8k\Omega$		300	450	$\mu A$
$I_{SD}$	Charge Function Shutdown Supply Current	$V_{ENB} = 5V$ , $V_{BAT} = 4.3V$		190	250	$\mu A$
$I_{BAT\_LEAK}$	Leakage Current from BAT Pin	$V_{BAT} = 4V$ , IN Pin Open		2	5	$\mu A$
<b>Over-Voltage Protection</b>						
$V_{OVP}$	Over-Voltage Protection Trip Voltage	$V_{IN}$ Rising Edge	7.05	7.25	7.45	V
$V_{OVP\_HYS}$	Hysteresis			200		mV
$V_{IN\_BAT\_OS}$	$V_{IN} - V_{BAT}$ Offset Voltage	$V_{IN}$ Rising, $V_{BAT} = 4V$ $V_{IN}$ Falling, $V_{BAT} = 4V$		300		mV
$V_{INCHR\_DO}$	Drop Out Voltage Between IN and INCHR Pins	$V_{IN} = 5V$ , $I_{BAT} = 500mA$ , $R_{SET} = 1.58k\Omega$		200		mV
<b>Battery Charger</b>						
$V_{UVLO}$	Under-Voltage Lockout Threshold	$V_{IN}$ Rising Edge	2.6	2.8	3.0	V
$V_{UVLO\_HYS}$	Hysteresis			200		mV
$V_{CHG\_DO}$	Drop Out Voltage Between INCHR and BAT Pins	$V_{IN} = 4.2V$ , $I_{BAT} = 500mA$ , $R_{SET} = 1.58k\Omega$		100		mV
$V_{BOVP}$	Battery Over-Voltage Protection Threshold			4.4		V
<b>BAT Pin Voltage Regulation</b>						
$V_{CO(REG)}$	Constant Regulated Output Voltage <sup>2</sup>	$R_{SET} = 31.6k\Omega$ , $I_{BAT} = 10mA$		4.20		V
$\Delta V_{CO}/V_{CO}$	Constant Output Voltage Tolerance	$R_{SET} = 31.6k\Omega$ , $I_{BAT} = 10mA$ , $T_A = 25^\circ C$ $R_{SET} = 31.6k\Omega$ , $I_{BAT} = 10mA$ , $T_A = -40$ to $+85^\circ C$	-0.5 -1		+0.5 +1	%
$V_{RCH}$	Battery Recharge Voltage Threshold (AAT3698-1 only)	$V_{BAT}$ falling		$V_{CO(REG)} - 0.1$		
$V_{MIN}$	Preconditioning Voltage Threshold	$V_{BAT}$ rising	2.4	2.6	2.8	V
<b>Current Regulation</b>						
$I_{CC\_RANGE}$	Charge Current Programmable Range		100		1600	mA
$I_{CH\_CC}$	Constant-Current Mode Charge Current	$R_{SET} = 15.8k\Omega$ , $V_{BAT} = 3.6V$ $R_{SET} = 3.16k\Omega$ , $V_{BAT} = 3.6V$ $R_{SET} = 1.58k\Omega$ , $V_{BAT} = 3.6V$	-15% -10% -10%	100 500 1000	+15% +10% +10%	mA
$V_{ISET}$	ISET Pin Voltage	$V_{BAT} = 3.6V$				
		$T_A = 25^\circ C$	1.97	2	2.03	V
		$T_A = -40$ to $+85^\circ C$	1.9	2	2.1	V
$I_{CH\_TRK\%}$	Trickle Charge Current Ratio	$R_{SET} = 3.16k\Omega$ , $V_{BAT} = 2.0V$	5	10	20	% of $I_{CH\_CC}$
$K_{ISET}$	Charge Current Set Factor: $I_{CH\_CC}/I_{ISET}$	$R_{SET} = 15.8k\Omega$ , $V_{BAT} = 3.6V$ $R_{SET} = 3.16k\Omega$ , $V_{BAT} = 3.6V$		790 790		
$V_{TERM}$	TERM Pin Voltage Range	From off to full charge	0		2.0	V
$V_{EXTERM\_DIS}$	External Termination Disable Threshold <sup>3</sup>	$V_{IN} = 5V$ , measured on TERM pin	4.8			V
$V_{EXTERM\_EN}$	External Termination Enable Threshold <sup>4</sup>	$V_{IN} = 5V$ , measured on TERM pin			3.5	V
$I_{TERM}$	TERM Pin Output Current	$V_{TERM} = 0.2V$	-10%	15	+10%	$\mu A$
$I_{CH\_TERM\%}$	Charge Termination Threshold Current Ratio	$V_{TERM} = 0.2V$ or tied to INCHR pin	5	10	20	% of $I_{CH\_CC}$

1. The AAT3698-1/-2 is guaranteed to meet performance specifications over the -40 to +85°C operating temperature range and is assured by design, characterization and correlation with statistical process controls.  
 2. When no battery is connected, the BAT pin output voltage is regulated at 4.2V.  
 3. Internal Termination function is selected when  $V_{TERM} > V_{EXTERM\_DIS}$ .  
 4. External Termination function is selected when  $V_{TERM} < V_{EXTERM\_EN}$ .

## 1.6A Linear Li-Ion Battery Charger in a 3x3 TDFN Package

Electrical Characteristics (continued)<sup>1</sup>

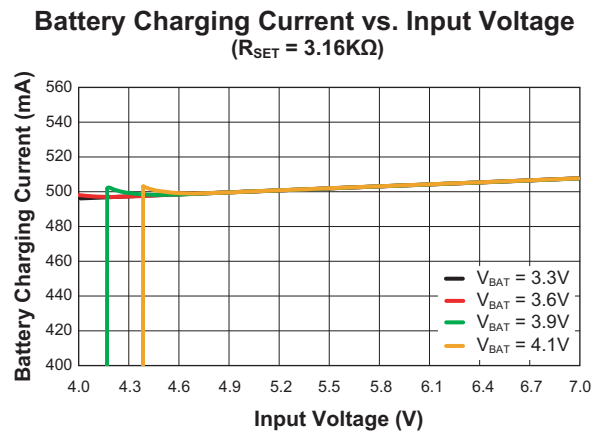
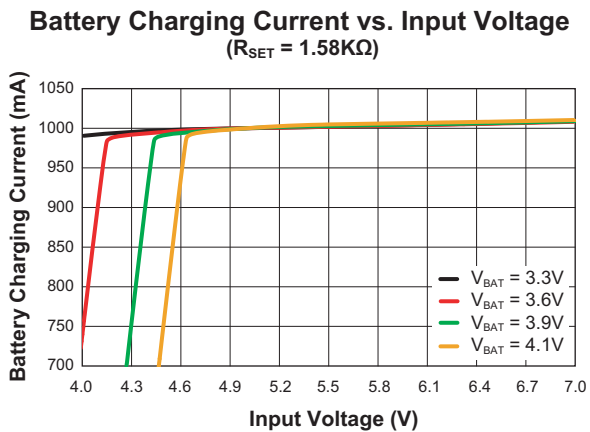
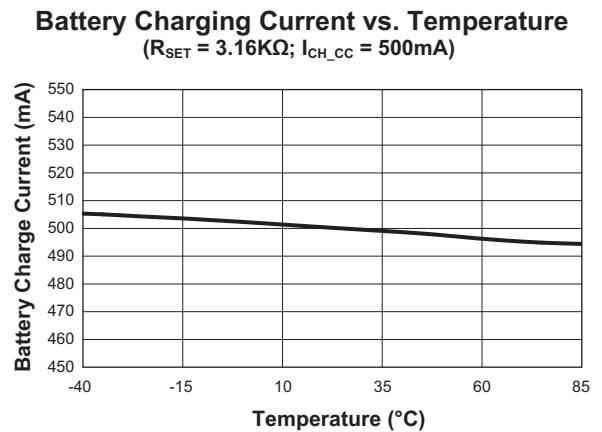
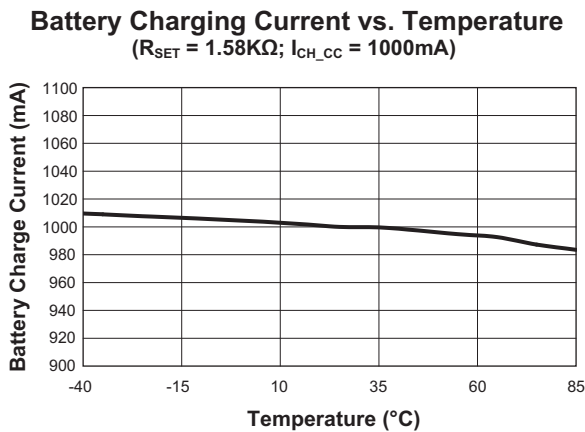
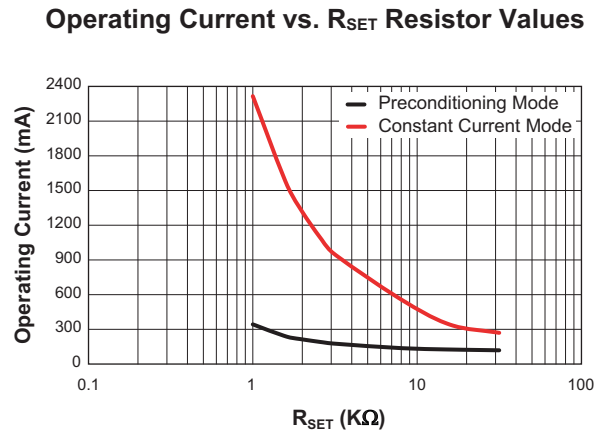
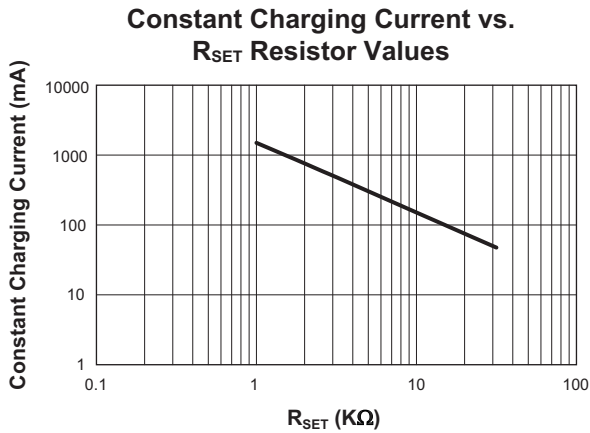
$V_{IN} = 5V$ ,  $R_{SET} = 3.16k\Omega$ ,  $V_{ENB} = V_{NOBAT} = 0V$ ,  $C_{IN} = 1\mu F$ ,  $C_{INCHR} = 1\mu F$ ,  $C_{BAT} = 1\mu F$ ,  $C_{LDOOUT} = 1\mu F$ ,  $TERM = ABI = IC = open$ ,  $T_A = -40$  to  $+85^\circ C$ , unless otherwise noted. Typical values are at  $T_A = 25^\circ C$ .

Symbol	Description	Conditions	Min	Typ	Max	Units	
<b>Logic Control / Battery Protection</b>							
$V_{EN(H)}$	Input High Threshold		1.2			V	
$V_{EN(L)}$	Input Low Threshold				0.4	V	
$R_{EN}$	Input Pull Down Resistor			200		k $\Omega$	
$V_{NOBAT(H)}$	Input High Threshold		1.2			V	
$V_{NOBAT(L)}$	Input Low Threshold				0.4	V	
$R_{NOBAT}$	Input Pull Up Resistor			1600		k $\Omega$	
$V_{ABI(H)}$	Input High Threshold	$V_{IN} = 0V$ , $V_{BAT} = 4.2V$	1.2			V	
$V_{ABI(L)}$	Input Low Threshold	$V_{IN} = 0V$ , $V_{BAT} = 4.2V$			0.4	V	
$R_{ABI}$	Input Pull Down Resistor			200		k $\Omega$	
$V_{ABO(H)}$	Output High Voltage	$V_{BAT} = 4.2V$ , $I_{ABO} = -5mA$ (sourcing)	$V_{BAT} - 1V$			V	
$V_{ABO(L)}$	Output Low Voltage	$V_{BAT} = 4.2V$ , $I_{ABO} = 5mA$ (sinking)			0.4	V	
$V_{STAT}$	Output Low Voltage				0.4	V	
$I_{STAT\_OFF}$	STAT Pin Leakage Current	$V_{STAT} = 5.5V$ , $V_{EN} = 5V$			1	$\mu A$	
$V_{POK}$	Output Low Voltage	$I_{POK} = 5mA$			0.4	V	
$I_{POK\_OFF}$	POK Pin Leakage Current	$V_{POK} = 5.5V$ , $V_{IN} = 7V$			1	$\mu A$	
$T_{OVRES}$	Over-Voltage Response Time	$V_{IN}$ voltage step up from 6V to 8V, $R_{LOAD} = 100\Omega$ , $C_{INCHR} = 1\mu F$		0.1		$\mu s$	
$T_{OVON}$	OVP Switch OVP Release Turn-On Delay Time	$V_{IN}$ voltage step down from 8V to 6V, $R_{LOAD} = 100\Omega$ , $C_{INCHR} = 1\mu F$		60		$\mu s$	
$T_{DLY\_POK}$	POK OFF Delay Time from Over-Voltage	$V_{IN}$ voltage step up from 6V to 8V, $R_{LOAD} = 100\Omega$ , $C_{INCHR} = 1\mu F$		0.1		$\mu s$	
$T_{REDLY\_POK}$	POK ON Delay Time from Over-Voltage	$V_{IN}$ voltage step down from 8V to 6V, $R_{LOAD} = 100\Omega$ , $C_{INCHR} = 1\mu F$		1.5		$\mu s$	
$T_{OVSTARTON}$	OVP Switch Startup Turn-On Delay Time	$V_{IN}$ voltage step up from 0V to 5V, $R_{LOAD} = 100\Omega$ , $C_{INCHR} = 1\mu F$		220		$\mu s$	
<b>Thermal Protection</b>							
$TH_{REG}$	Thermal Loop Regulation			110		$^\circ C$	
$TH_{SHDN}$	Chip Thermal Shutdown Temperature	Threshold		140		$^\circ C$	
		Hysteresis		15			
<b>5V LDO</b>							
$V_{LDOOUT}$	LDOOUT Voltage Tolerance	$V_{IN} = 5.5V$ , $I_{LDOOUT} = 0mA$ to $30mA$	$T_A = 25^\circ C$	4.9	5.0	5.1	V
			$T_A = -40$ to $+85^\circ C$	4.75	5.0	5.25	
$V_{DO}$	Dropout Voltage from IN	$I_{OUT} = 30mA$ , $V_{IN} = 5.0V$		160	300	mV	
$I_{OUT\_LIM}$	LDO Output Current Limit	$V_{IN} = 5.5V$ , $V_{LDOOUT} = 4.5V$	55	90	125	mA	
$V_{LDOOUT\_LR}$	Line Regulation	$V_{IN} = 5.4V$ to $6.4V$ , $I_{LDOOUT} = 30mA$			10	mV	
$V_{LDOOUT\_DM\_LR}$	Dynamic Line Regulation	$I_{OUT} = 30mA$ , $V_{IN} = 5.4V$ to $6.4V$ , $T_R/T_F = 2\mu s$		200		mV	
$V_{LDOOUT\_DM\_LD}$	Dynamic Load Regulation	$I_{OUT} = 1mA$ to $30mA$ , $T_R = <5\mu s$ , $V_{IN} = 5.5V$		60		mV	

1. The AAT3698-1/-2 is guaranteed to meet performance specifications over the  $-40$  to  $+85^\circ C$  operating temperature range and is assured by design, characterization and correlation with statistical process controls.

## 1.6A Linear Li-Ion Battery Charger in a 3x3 TDFN Package

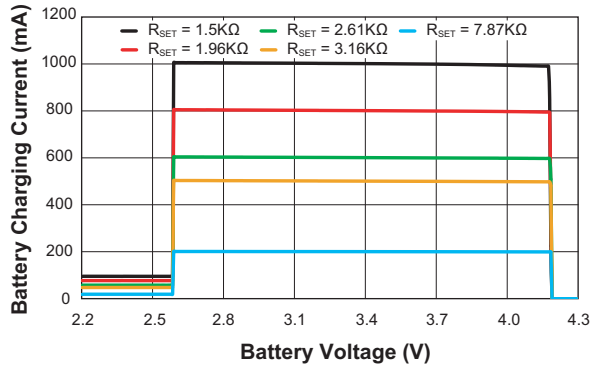
### Typical Characteristics – Battery Charger



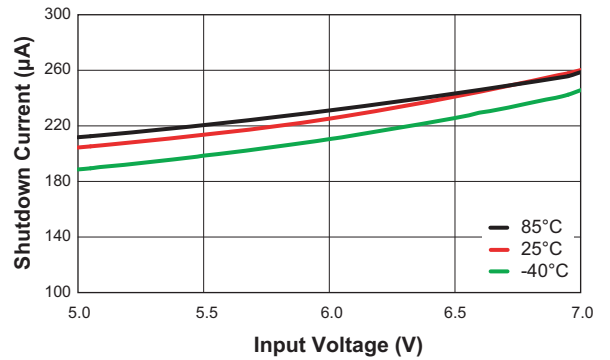
## 1.6A Linear Li-Ion Battery Charger in a 3x3 TDFN Package

### Typical Characteristics–Battery Charger

**Battery Charging Current vs. Battery Voltage**

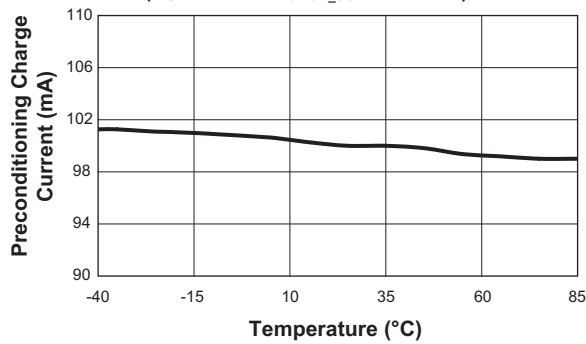


**Shutdown Current vs. Input Voltage**



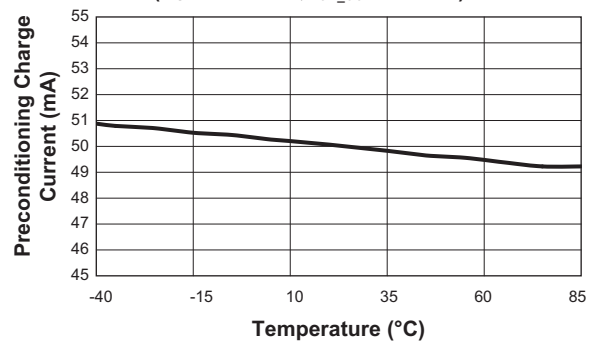
**Preconditioning Charge Current vs. Temperature**

( $R_{SET} = 1.58K\Omega$ ;  $I_{CH\_CC} = 1000mA$ )



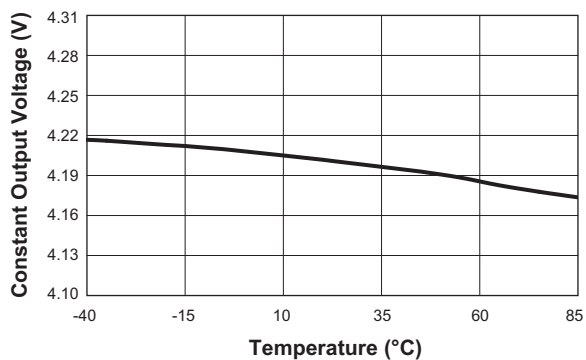
**Preconditioning Charge Current vs. Temperature**

( $R_{SET} = 3.16K\Omega$ ;  $I_{CH\_CC} = 500mA$ )



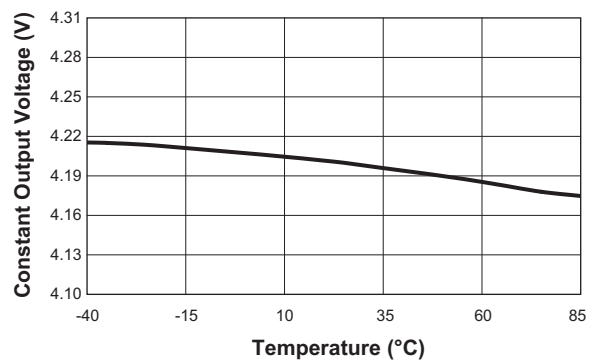
**Constant Output Voltage vs. Temperature**

( $R_{SET} = 1.58K\Omega$ ;  $I_{CH\_CC} = 1000mA$ )



**Constant Output Voltage vs. Temperature**

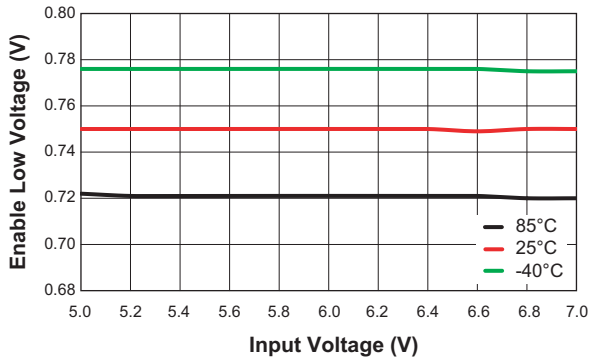
( $R_{SET} = 3.16K\Omega$ ;  $I_{CH\_CC} = 500mA$ )



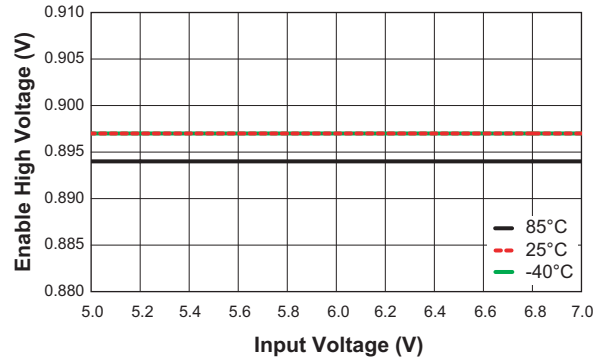
## 1.6A Linear Li-Ion Battery Charger in a 3x3 TDFN Package

### Typical Characteristics–Battery Charger

**Enable Low Voltage vs. Input Voltage**

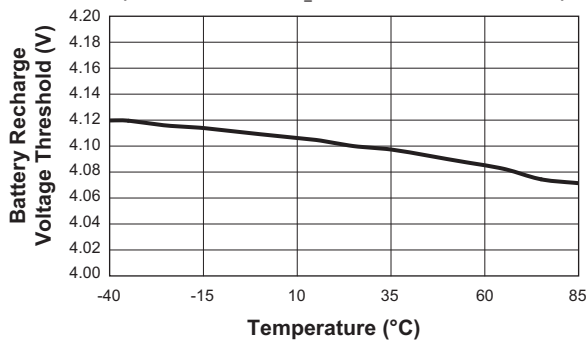


**Enable High Voltage vs. Input Voltage**



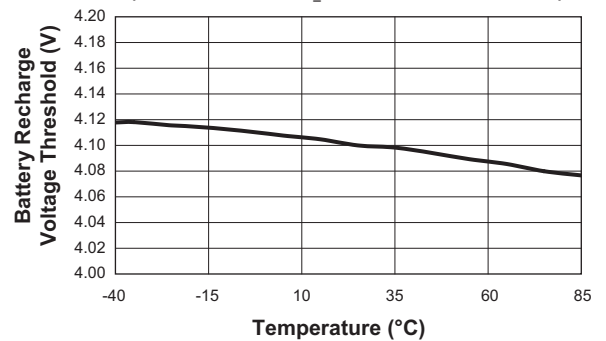
**Battery Recharge Voltage Threshold vs. Temperature**

( $R_{SET} = 1.58K\Omega$ ;  $I_{CH\_CC} = 1000mA$ ; AAT3698-1)



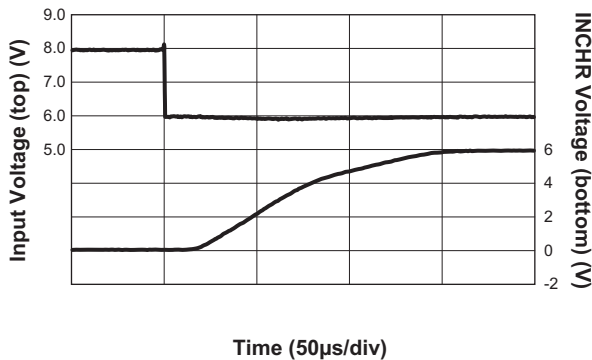
**Battery Recharge Voltage Threshold vs. Temperature**

( $R_{SET} = 3.16K\Omega$ ;  $I_{CH\_CC} = 500mA$ ; AAT3698-1)

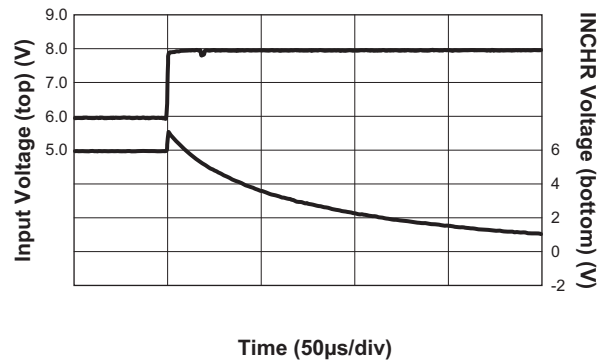


### Typical Characteristics–OVP

**OVP On Time**  
( $R_{LOAD} = 100\Omega$ )



**OVP Response Time**  
( $R_{LOAD} = 100\Omega$ )

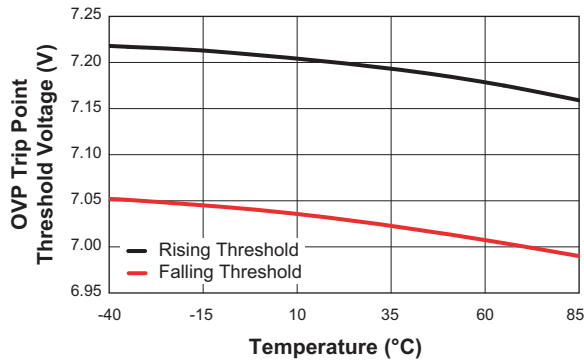




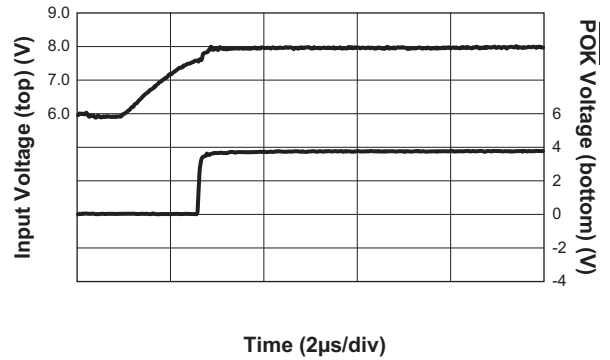
## 1.6A Linear Li-Ion Battery Charger in a 3x3 TDFN Package

### Typical Characteristics–OVP

**OVP Trip Point Threshold Voltage vs. Temperature**



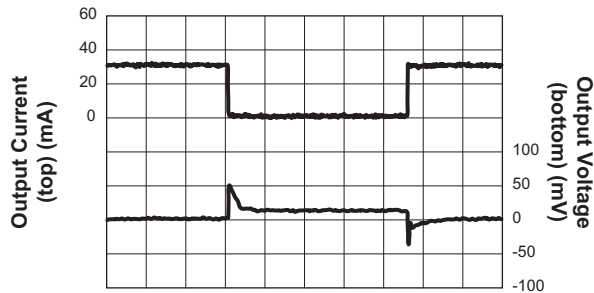
**POK ON Delay Time (R<sub>LOAD</sub> = 100Ω)**



### Typical Characteristics–LDO

**LDO Load Transient**

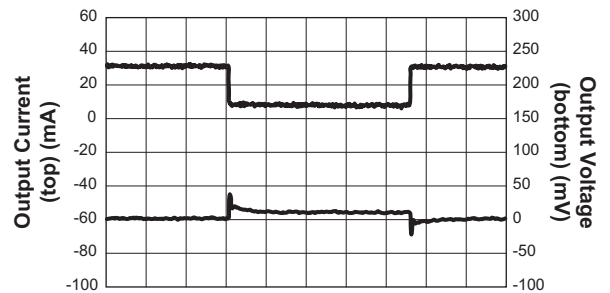
(V<sub>IN</sub> = 5.4V; I<sub>OUT</sub> = 1mA to 30mA; C<sub>OUT</sub> = 1μF)



Time (100μs/div)

**LDO Load Transient**

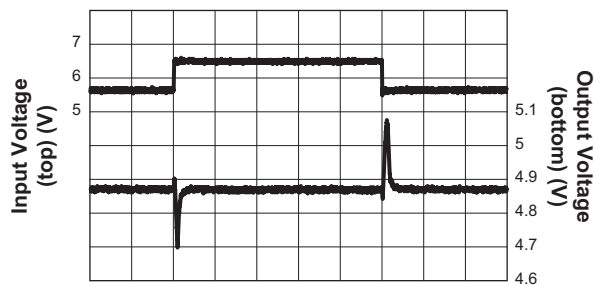
(V<sub>IN</sub> = 5.4V; I<sub>OUT</sub> = 10mA to 30mA; C<sub>OUT</sub> = 1μF)



Time (100μs/div)

**LDO Line Transient**

(V<sub>IN</sub> = 5.4V to 6.4V; I<sub>OUT</sub> = 30mA; C<sub>OUT</sub> = 1μF)

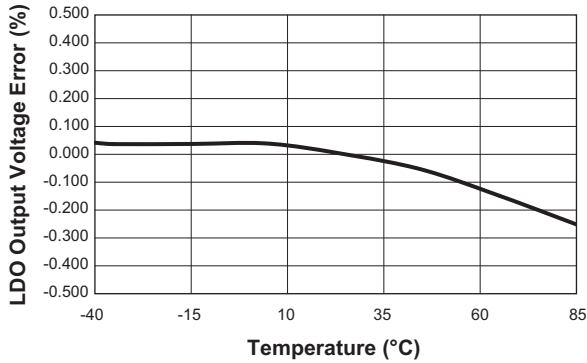


Time (100μs/div)

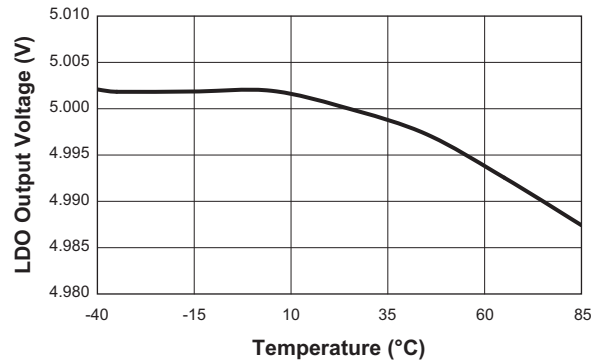
1.6A Linear Li-Ion Battery Charger in a 3x3 TDFN Package

**Typical Characteristics–LDO**

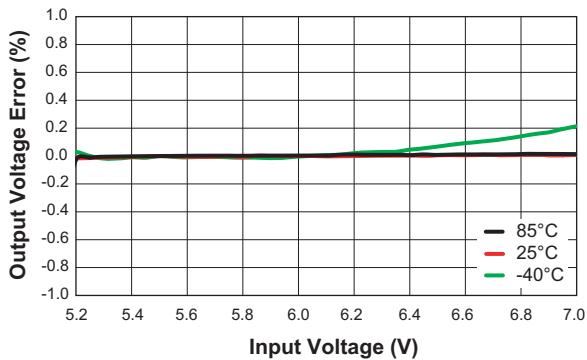
**LDO Output Voltage Accuracy vs. Temperature**  
 ( $I_{OUT} = 10mA$ )



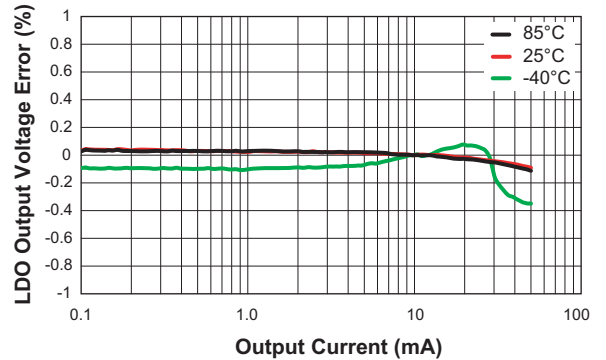
**LDO Output Voltage vs. Temperature**  
 ( $I_{OUT} = 10mA$ )



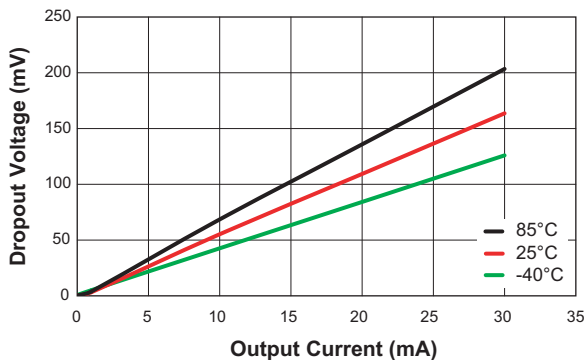
**LDO Output Voltage Accuracy vs. Input Voltage**  
 ( $I_{OUT} = 30mA$ )



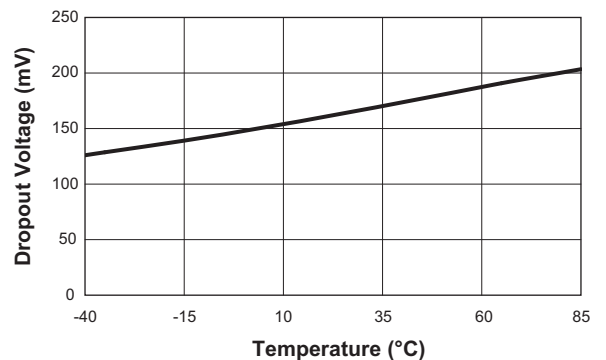
**LDO Output Voltage Accuracy vs. Output Current**  
 ( $V_{IN} = 5.5V$ )



**Dropout Voltage vs. Output Current**

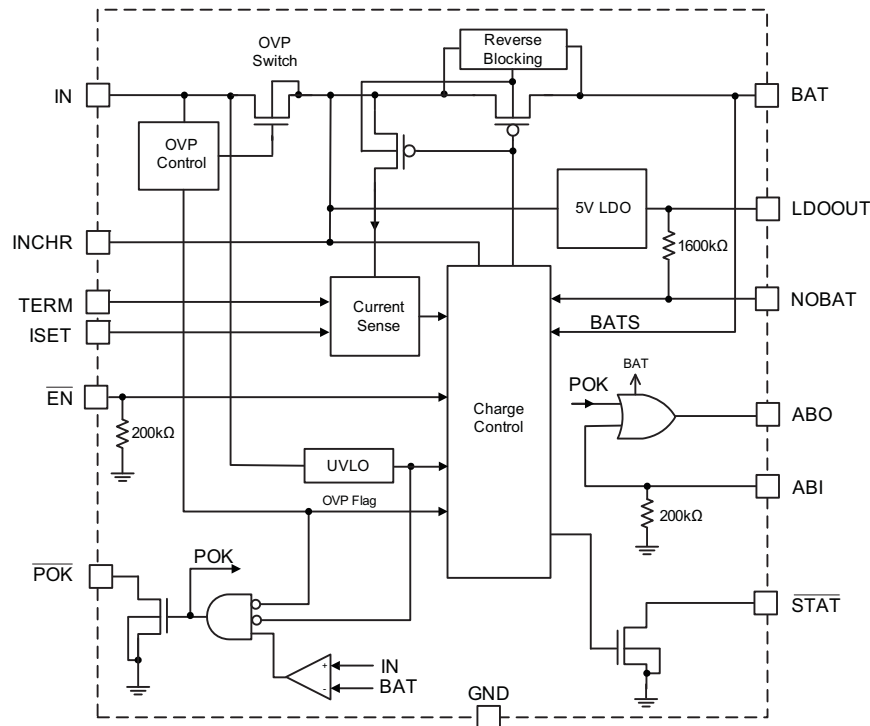


**Dropout Voltage vs. Temperature**  
 ( $I_{OUT} = 30mA$ )



## 1.6A Linear Li-Ion Battery Charger in a 3x3 TDFN Package

### Functional Block Diagram



### Functional Description

The AAT3698-1/-2 is a high performance battery charger IC which is designed to charge single-cell Lithium-Ion or Polymer batteries with up to 1.6A of current from an external power source. It is a stand-alone charging solution requiring minimum input components. The AAT3698-1/-2 also includes a fast turn-off over-voltage protection (OVP) circuit with +28V which consists of a low-resistance MOSFET in series with the charge control circuit. The AAT3698-1/-2 also features under-voltage lockout protection, power OK, charge status monitoring, and a 5.0V LDO with 50mA output through the OVP switch.

### Battery Charging Profile

Figure 1 illustrates the entire battery charging operation profile, which consists of three (AAT3698-2) or four (AAT3698-1) phases:

1. Preconditioning (Trickle) Charge
2. Constant Current Charge (CC)
3. Constant Voltage Charge (CV)
4. Automatic Recharge (AAT3698-1 only)

### Preconditioning Charge

Battery charging commences only after the AAT3698-1/-2 checks several conditions in order to maintain a safe charging environment. The input supply must be above the minimum operating voltage ( $V_{MIN}$ ) or under-voltage lockout threshold ( $V_{UVLO}$ ) and the enable pin must be low for the charging sequence to begin. When these conditions have been met and a battery is connected to the BAT pin, the AAT3698-1/-2 checks the state of the battery and determines which charging mode to apply. If the battery voltage is below the preconditioning voltage threshold ( $V_{MIN}$ ), then the AAT3698-1/-2 begins preconditioning the cell (trickle charging) by charging at 10% of the programmed constant current. For example, if the programmed fast charge current is 1000mA, then the preconditioning (trickle) charge current is 100mA. Battery cell preconditioning is a safety precaution for deeply discharged cells and will also reduce the power dissipation in the internal series pass transistor when the voltage across the device is at greatest potential.

**1.6A Linear Li-Ion Battery Charger in a 3x3 TDFN Package**

**Constant Current Fast Charge**

Battery cell preconditioning charge continues until the battery voltage reaches the preconditioning voltage threshold ( $V_{MIN}$ ). At this point, the AAT3698-1/-2 begins the constant current charge phase. The current level for this mode is programmed using a single resistor from the ISET pin to ground. The programmed current can be set from a minimum of 100mA up to a maximum of 1.6A.

**Constant Voltage Charge**

Constant current charging will continue until the battery voltage reaches the constant output voltage,  $V_{CO}$ . The AAT3698-1/AAT3698-2 then transitions to constant voltage mode, in which the charge IC regulates the battery voltage to a constant output voltage (factory programmed to 4.2V). The charging current decreases during this phase. The charger regulates battery voltage at 4.2V and continues to charge the battery until the charge current

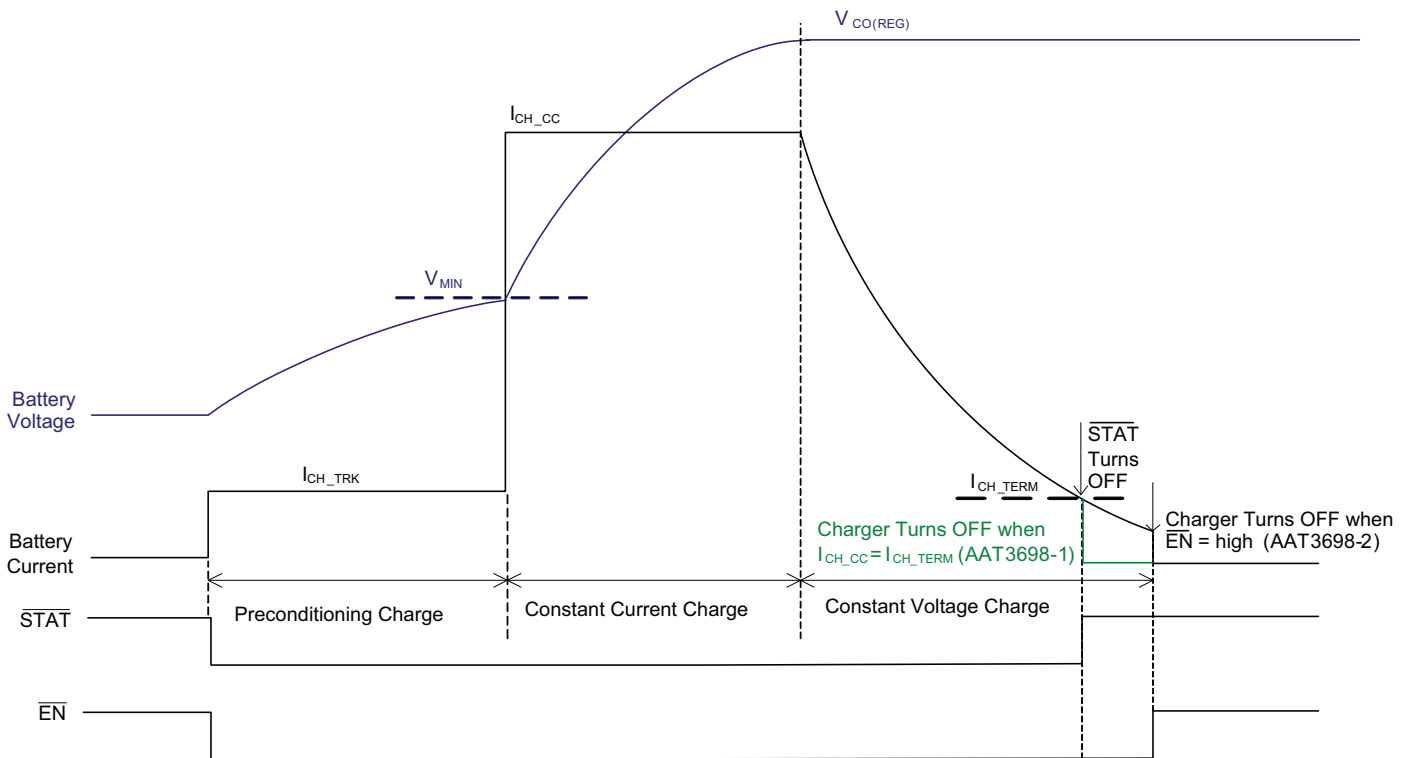
reaches the termination level set by  $R_{TERM}$ . When the charge current reaches its termination level  $I_{TERM}$ , charging is terminated.

**AAT3698-1**

The charger turns off the series pass device even if the  $\overline{EN}$  pin is held low and the device automatically enters a power-saving sleep state. During this time, the series pass device blocks current in both directions, preventing the battery from discharging through the IC. The device remains in sleep mode even if the charger source is disconnected. When the battery terminal voltage drops below the  $V_{RCH}$  threshold, the AAT3698-1 resumes charging operation if no fault is detected.

**AAT3698-2**

The charger regulates the battery voltage at 4.2V and continues to charge the battery with a current lower than the charge termination current until a logic high is applied to the  $\overline{EN}$  pin to stop charging.



**Figure 1: AAT3698-1/-2 Battery Charging Profile.**

## 1.6A Linear Li-Ion Battery Charger in a 3x3 TDFN Package

### Enable / Disable

The AAT3698-1/-2 provides an enable function to turn the charger IC on and off. The enable (EN) pin is internally pulled down with 200kΩ. When EN is pulled down or left floating, the device begins normal operation. When EN is pulled to a logic high level, the AAT3698-1/-2's charging circuit will be shut down and forced into sleep state. The over-voltage protection/LDO circuit remains active even in sleep state. In sleep state, charging is halted regardless of the battery voltage or charging state. When the device is re-enabled, the charge control circuit automatically resets and resumes charging functions with the appropriate charging mode based on the battery charge state and measured cell voltage at the BAT pin.

### Under-Voltage Lockout (UVLO)

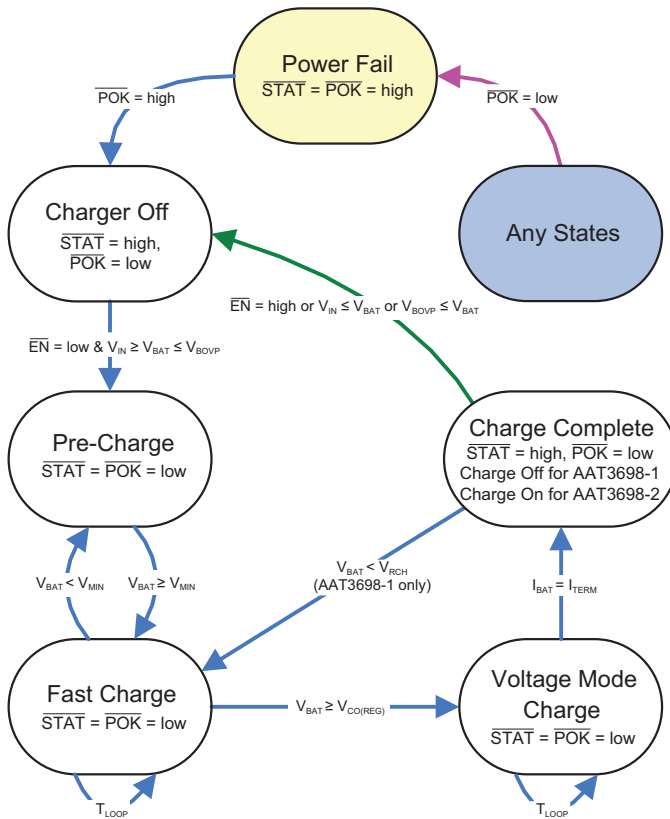
The AAT3698-1/-2 has a typical under-voltage lockout threshold of 3V. When the input voltage is less than the UVLO level, OVP and the charger are turned off. The UVLO is designed with 150mV hysteresis to ensure circuit stability.

### Over-Voltage Protection

In normal operation, the OVP protection device acts as a load switch, connecting the power source from IN to INCHR. This switch is designed with very low resistance to minimize the voltage drop between the power source and the charger and to reduce the power dissipation. When the voltage on the power source exceeds the OVP trip point,  $V_{OVP}$ , the switch immediately turns off and disconnects the load and the charger from the power source and preventing damage to any downstream components. Simultaneously, the fault flag is raised, alerting the system. If an over-voltage condition is applied at the time of the device enable, the switch remains open (OFF).

### Power OK Output Flag

The Power OK flag ( $\overline{POK}$ ) is an active-low open-drain power good reporting output. A pull-up resistor should be connected from  $\overline{POK}$  to another system power voltage. In the event of an under-voltage or over-voltage condition,  $\overline{POK}$  will be de-asserted. After the over-voltage fault is released,  $\overline{POK}$  will be asserted.  **$\overline{POK}$  will be also de-asserted when  $V_{IN}$  is lower than  $V_{BAT}$  when EN is low.** When EN is high,  $\overline{POK}$  is asserted only after UVLO and OVP conditions.



**Figure 2: Charger Operational State Diagram.**

### Charge Status Output

The AAT3698-1/-2 provides battery charging status via the charge status indication pin (STAT). This pin is internally connected to an N-channel open-drain MOSFET, which can be used as a logic signal or to drive an external LED. The STAT pin pulls high to indicate charge completion. The charge completion occurs only when the EN pin is pulled high or the charge current reaches its charge termination current level. The status pin indicates the conditions as described in Table 1.

Charge Status	STAT
$V_{IN} > V_{UVLO}$	High
$V_{IN} > V_{OVP}$	High
The charge current is below its termination level	High
EN pin is pulled high	High
Battery is charging and the charge current is above its termination level.	Low

**Table 1: LED Status Indicator.**

**1.6A Linear Li-Ion Battery Charger in a 3x3 TDFN Package**

Power Status	POK
$V_{IN} < V_{UVLO}$	High
$V_{IN} > V_{OVP}$	High
$V_{IN} < V_{BAT} + V_{IN\_BAT\_OS}, \overline{EN} = \text{low}$	High
$V_{UVLO} \leq V_{BAT} + V_{IN\_BAT\_OS} \leq V_{IN} \leq V_{OVP}$	Low

**Table 2: POK Flag Indicator.****Automatic Booting**

An auxiliary OR gate provides a booting enable signal from two inputs, an internal power OK signal and an external ABI signal. The ABO states are listed in Table 3.

$V_{BAT}$	POK	ABI	ABO
Yes	Low	X	High
Yes	High	High	High
Yes	High	Low	Low
No	X	X	Low

**Table 3: Automatic Booting.****Battery Detection**

When the NOBAT pin is set to logic high level, the charger is disabled. When it is set to logic low level, the charger is enabled. This pin is internally pulled to the LDOOUT pin through a 1.6M $\Omega$  resistor.

**Battery Over-Voltage Protection**

An over-voltage event is defined as a condition where the voltage at the BAT pin exceeds the maximum battery charge voltage and is set by the battery over-voltage

protection threshold ( $V_{BOVP}$ ). If an over-voltage condition is sensed by the BATS pin, the AAT3698-1/-2 charge control shuts down the device until the voltage at the BAT pin drops below  $V_{BOVP}$ . The AAT3698-1/-2 resumes normal charging operation after the over-voltage condition is removed.

**Digital Thermal Loop Control**

The AAT3698-1/-2 includes a thermal management system. The system is activated when the die temperature reaches its preset internal temperature threshold (110°C) and maintains the die temperature by reducing the constant charge current.

**Over-Temperature Shutdown**

The AAT3698-1/-2 has a thermal protection control circuit which shuts down charging functions if the internal die temperature exceeds the preset thermal limit threshold (140°C). Once the internal die temperature falls below the thermal limit, normal operation resumes in the previous charging state.

**Linear Dropout Regulator**

The AAT3698-1/-2's linear dropout regulator output (LDOOUT) provides 5V output with 30mA typical load current capabilities.

**IC Input**

The AAT3698-1/-2 has an IC input pin that is internally connected to ground through a 100k $\Omega$  resistor. Float or ground this pin for normal operation.

## 1.6A Linear Li-Ion Battery Charger in a 3x3 TDFN Package

### Application Information

#### Constant Charge Current

The constant current charge level is user programmed with a set resistor connected between the ISET pin and ground. The tolerance of the set resistor determines the accuracy of the constant charge current as well as the preconditioning trickle charge current. For this reason, a 1% tolerance metal film resistor is recommended for the set resistor function. The constant charge current level from 100mA to 1.6A is set by selecting the appropriate resistor value from Table 4.

The approximate charge current ( $I_{CH\_CC\_typ}$ ) can be found using the following formula:

$$I_{CH\_CC\_TYP} = \frac{V_{ISET}}{R_{ISET}} \cdot K_{ISET} = V_{ISET} \cdot GM_{OUT}$$

Where:

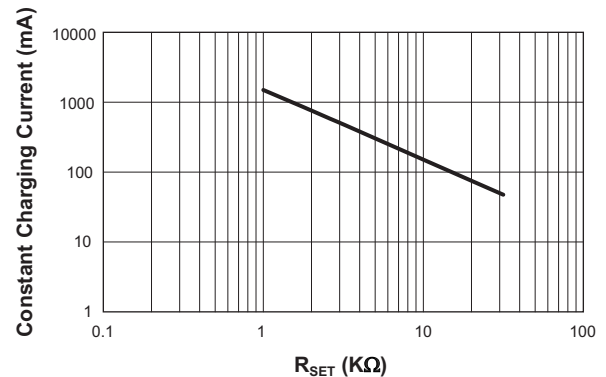
$$GM_{OUT} = \frac{I_{CH\_CC\_TYP}}{V_{ISET}} = \frac{K_{ISET}}{R_{SET}} = 250ms$$

When  $R_{SET} = 3.16k\Omega$  and  $K_{ISET} = 790$ .

Typical Constant Charge Current (mA)	Set Resistor Value (kΩ)
50	31.6
100	15.8
200	7.87
400	3.92
500	3.16
600	2.67
800	1.96
1000	1.58
1580	1.00

**Table 4: R<sub>SET</sub> Values**

Figure 3 shows the relationship of constant charging current and set resistor values for the AAT3698-1/-2.



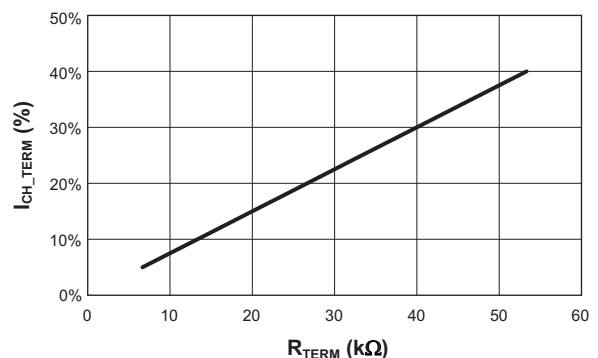
**Figure 3: Constant Charging Current vs. Set Resistor Values.**

#### Charge Termination Current

The charge termination current level is programmed by an external resistor ( $R_{TERM}$ ) connected between the TERM pin and ground. Use the resistor values listed in Table 5 to set the desired charge termination current.

R <sub>TERM</sub> (KΩ)	I <sub>CH_TERM</sub> (%)
6.65	5%
13.3	10%
26.7	20%
40.2	30%
53.6	40%

**Table 5: Charge Termination Current Programming Resistor Values.**



**Figure 4: Charge Termination Current vs. R<sub>TERM</sub>.**

## 1.6A Linear Li-Ion Battery Charger in a 3x3 TDFN Package

Use the following formula to set the charge termination current,  $I_{CH\_TERM}$ .

$$I_{CH\_TERM} = \frac{15\mu A \cdot R_{TERM}}{2V} \cdot I_{CH\_CC}$$

$I_{CH\_TERM}$  is set by default to 10% of  $I_{CH\_CC}$  when the TERM pin is connected to the INCHR pin.

When the charge current reaches the termination current, the  $\overline{STAT}$  pin will be set to high impedance, but the charge termination current will continue to flow until the  $\overline{EN}$  pin is toggled high. To set charge termination current threshold to the lowest level, connect the TERM pin to ground.

### **Battery Connection**

A single cell Li-Ion/Polymer battery should be connected between the BAT pin and ground.

### **Status Indicator Display**

Simple system charging status can be displayed using a single LED in conjunction with the AAT3698-1/-2's  $\overline{STAT}$  pin. This pin has a simple switch connecting the LED's cathode to ground. Refer to Table 1 for LED display definitions. The LED anodes should be connected to INCHR or other system power supply that does not exceed 7V, depending upon system design requirements. The LED should be biased with as little current as necessary to create reasonable illumination; therefore, a ballast resistor should be placed between the LED cathode and the  $\overline{STAT}$  pin. LED current consumption will add to the overall thermal power budget for the device package, so it is wise to keep the LED drive current to a minimum. 2mA should be sufficient to drive most low-cost green or red LEDs. Driving an individual status LED with over 8mA is not recommended.

The required ballast resistor value can be estimated using the following formulas:

When connecting to the adapter supply with a red LED:

$$R_{B(\overline{STAT})} = \frac{V_{ADP} - V_{F(LED)}}{I_{LED(\overline{STAT})}}$$

Example:

$$R_{B(\overline{STAT})} = \frac{5.5V - 2.0V}{2mA} = 1.75k\Omega$$

Note: Red LED forward voltage ( $V_F$ ) is typically 2.0V @ 2mA.

When connecting to the USB supply with a green LED:

$$R_{B(\overline{STAT})} = \frac{V_{USB} - V_{F(LED)}}{I_{LED(\overline{STAT})}}$$

Example:

$$R_{B(\overline{STAT})} = \frac{5.0V - 3.2V}{2mA} = 900\Omega$$

Note: Green LED forward voltage ( $V_F$ ) is typically 3.2V @ 2mA.

### **Capacitor Selection**

#### **Input Capacitor (IN)**

A 1 $\mu$ F or larger capacitor is typically recommended for  $C_{IN}$ .  $C_{IN}$  should be located as close to the device IN pin as practically possible. Ceramic, tantalum, or aluminum electrolytic capacitors may be selected for  $C_{IN}$ . There is no specific capacitor equivalent series resistance (ESR) requirement for  $C_{IN}$ . However, for higher current operation, ceramic capacitors are recommended for  $C_{IN}$  due to their inherent capability over tantalum capacitors to withstand input current surges from low impedance sources such as batteries in portable devices.

Typically, 50V rated capacitors are required for the application to prevent any surge voltage. Ceramic capacitors selected as small as 1206 are available which can meet these requirements. Capacitors with other voltage rating can also be used for known input voltage applications.

#### **Charger Input Capacitor (INCHR)**

A 1 $\mu$ F decoupling capacitor is recommended to be placed between INCHR and GND. This capacitor should be located as closely and routed as directly as practically possible to the device's INCHR pin with a good ground return path for maximum device over-voltage protection performance.



**1.6A Linear Li-Ion Battery Charger in a 3x3 TDFN Package****Charger Output Capacitor (BAT)**

The AAT3698-1/-2 only requires a 1 $\mu$ F ceramic capacitor on the BAT pin to maintain circuit stability. This value should be increased to 10 $\mu$ F or more if the battery connection is made at any distance from the charger output. If the AAT3698-1/-2 is used in applications where the battery can be removed from the charger, such as desktop charging cradles, an output capacitor greater than 10 $\mu$ F may be required to prevent the device from cycling on and off when no battery is present.

**Linear Regulator Output Capacitor (LDOOUT)**

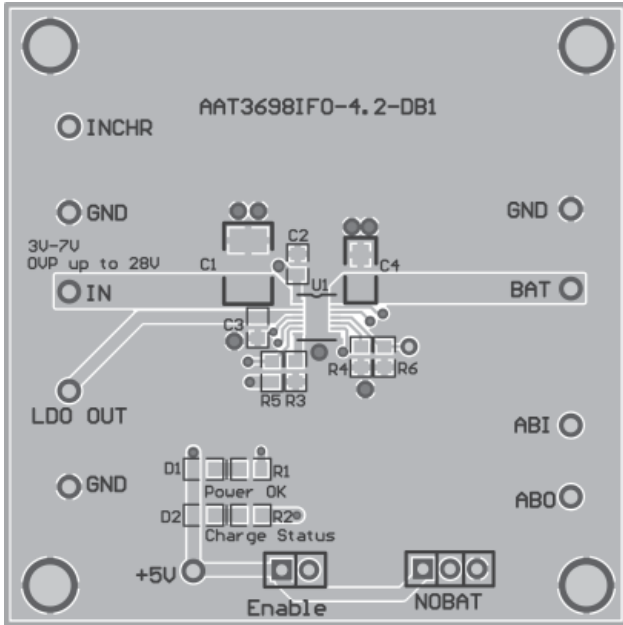
For proper load voltage regulation and operational stability, a capacitor is required between LDOOUT and GND. The output capacitor connection to the LDO regulator ground pin should be made as directly as practically possible for maximum device performance. Since the regulator has been designed to function with very low ESR capacitors, multilayer ceramic capacitors in the 1.0 $\mu$ F to 10 $\mu$ F range are recommended for best performance.

Applications utilizing the exceptionally low output noise and optimum power supply ripple rejection of the AAT3698-1/-2 should use a value of 2.2 $\mu$ F or greater for the LDO's output capacitor.

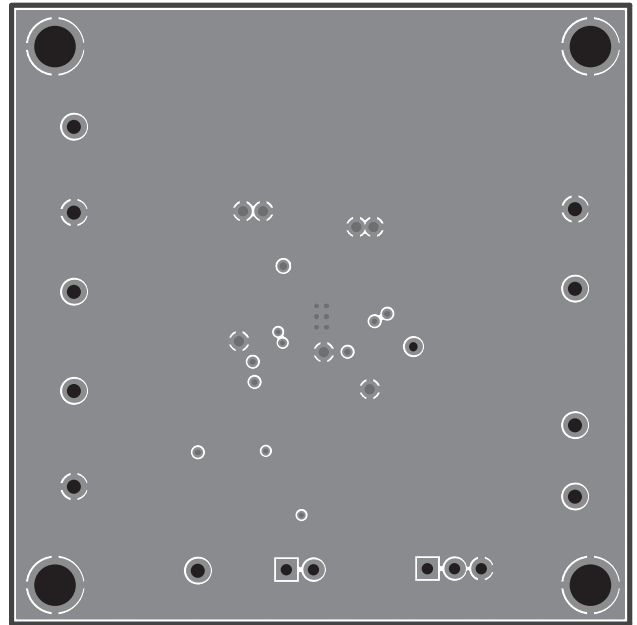
**Printed Circuit Board  
Layout Recommendations**

For proper thermal management and to take advantage of the low  $R_{DS(ON)}$  of the AAT3698-1/-2, a few circuit board layout rules should be followed: IN and BAT should be routed using wider than normal traces, and GND should be connected to a ground plane. To maximize package thermal dissipation and power handling capacity of the AAT3698-1/-2 TDFN33-14 package, solder the exposed paddle of the IC to the thermal landing of the PCB, where the thermal landing is connected to the ground plane. If heat is still an issue, multi-layer boards with dedicated ground planes are recommended. Also, adding more thermal via holes on the thermal landing would help transfer heat to the PCB effectively.

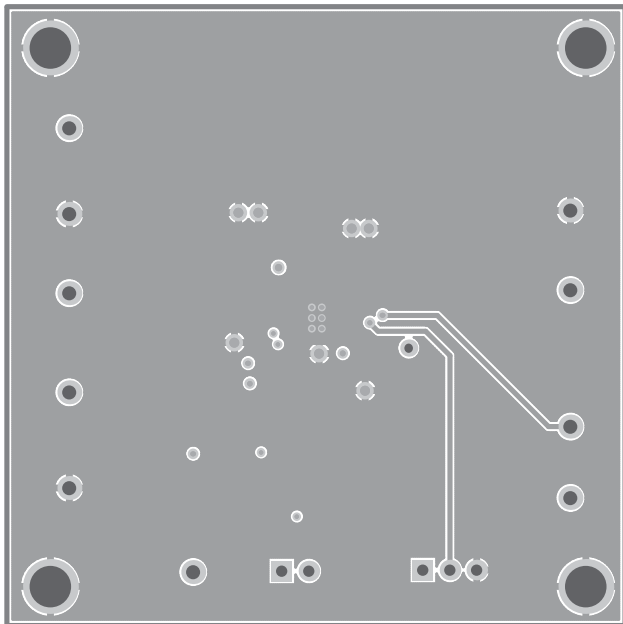
*1.6A Linear Li-Ion Battery Charger in a 3x3 TDFN Package*



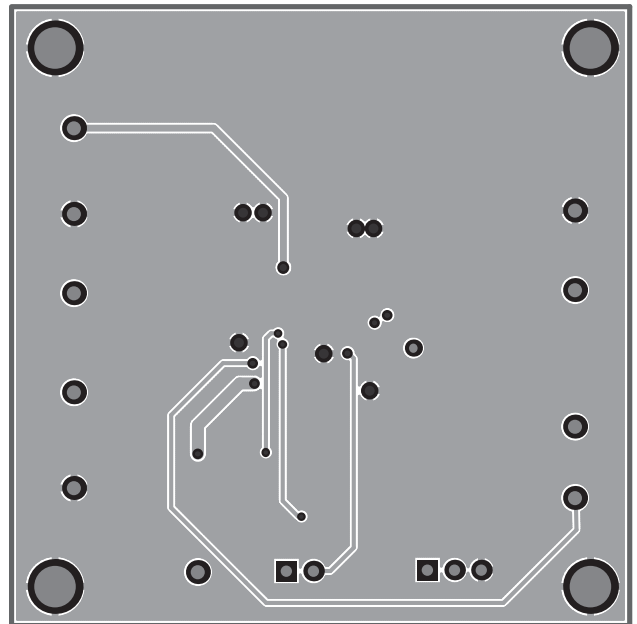
**Figure 5: AAT3698-1/-2 Evaluation Board Top Side Layout.**



**Figure 6: AAT3698-1/-2 Evaluation Board Mid1 Layer Layout.**

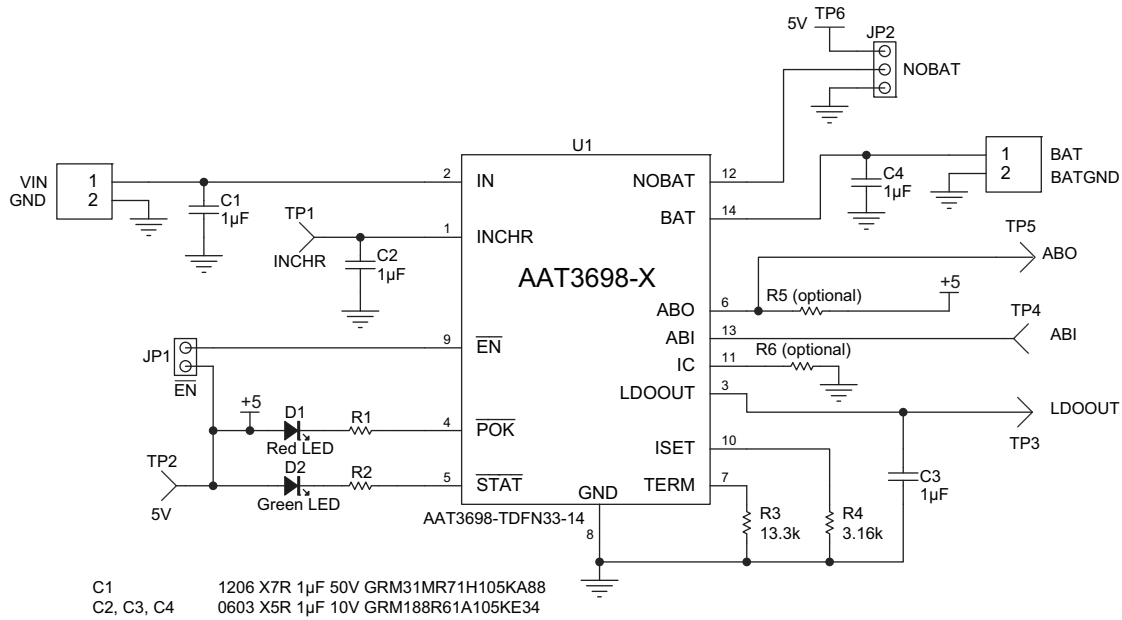


**Figure 7: AAT3698-1/-2 Evaluation Board Mid2 Layer Layout.**



**Figure 8: AAT3698-1/-2 Evaluation Board Bottom Side Layout.**

## 1.6A Linear Li-Ion Battery Charger in a 3x3 TDFN Package



**Figure 7: AAT3698-1/-2 Evaluation Board Schematic.**

Component	Part Number	Description	Manufacturer
U1	AAT3698IWO-1/-2	1.6A Linear Li-Ion/Polymer Battery Charger in TDFN33-14 Package	Skyworks
C1	GRM31MR71H105KA88	Ceramic 1µF/50V, 10%, X7R, 1206	Murata
C2, C3, C4	GRM188R61A105KE34	Ceramic 1µF/10V, 10%, X5R, 0603	Murata
R1, R2	Chip Resistor	1.5kΩ, 5%, 1/4W, 0603	Vishay
R3	Chip Resistor	13.3kΩ, 1%, 1/4W, 0603	Vishay
R4	Chip Resistor	1.58kΩ, 1%, 1/4W, 0603	Vishay
R5	Chip Resistor	10kΩ, 1%, 1/4W, 0603	Vishay
R6	Chip Resistor	0Ω, 5%, 1/4W, 0603	Vishay
D1	LST-C190CKT	Red LED, 0603	Lite-On Inc.
D2	LST-C190GKT	Green LED, 0603	Lite-On Inc.
JP1, JP2	PRPN401PAEN	Conn. Header, 2mm zip	Sullins Electronics

**Table 6: AAT3698-1/-2 Evaluation Board Bill of Materials (BOM).**


Product	Constant Regulated Output Voltage (V)	Automatic Charge Termination and Recharge Sequencing when $I_{BAT} \leq I_{TERM}$	Input OVP Trip Point (V)	Preconditioning Voltage Threshold (V)
AAT3698-1	4.2	Yes	7.25	2.6
AAT3698-2	4.2	No	7.25	2.6

**Table 7: AAT3698 Options.**

**1.6A Linear Li-Ion Battery Charger in a 3x3 TDFN Package**

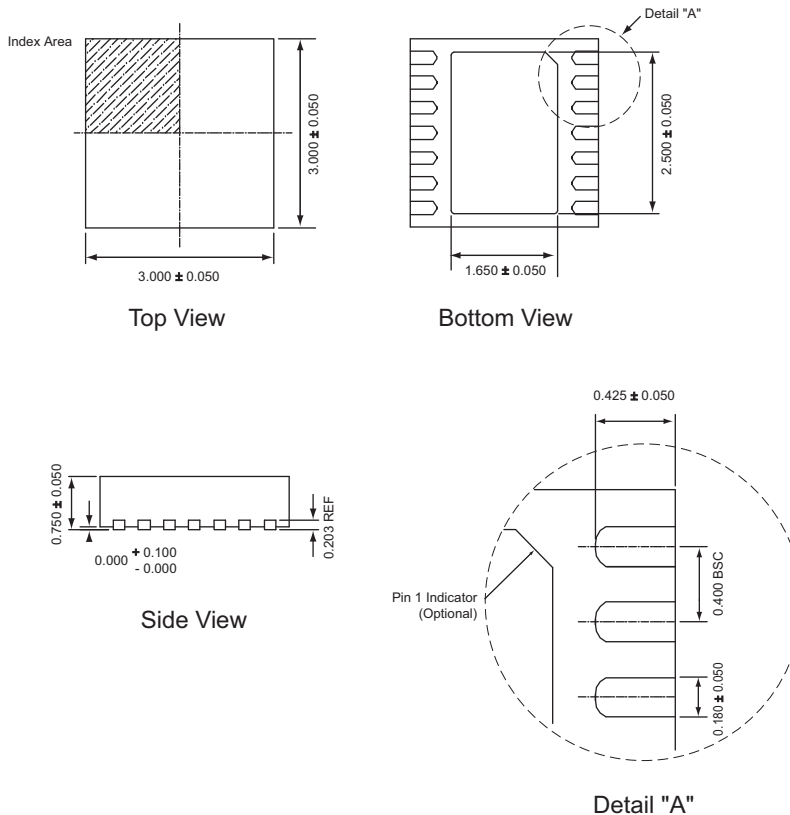
**Ordering Information**

Product	Package	Marking <sup>1</sup>	Part Number (Tape and Reel) <sup>2</sup>
AAT3698-1	TDFN33-14	A5XXY	<b>AAT3698IWO-4.2-1-T1</b>
AAT3698-2	TDFN33-14	D6XXY	<b>AAT3698IWO-4.2-2-T1</b>

 Skyworks Green™ products are compliant with all applicable legislation and are halogen-free. For additional information, refer to *Skyworks Definition of Green™*, document number SQ04-0074.

**Package Information**

**TDFN33-14**



All dimensions in millimeters.

1. XYY = assembly and date code.
2. Sample stock is generally held on part numbers listed in **BOLD**.
3. The leadless package family, which includes QFN, TQFN, DFN, TDFN and STDFN, has exposed copper (unplated) at the end of the lead terminals due to the manufacturing process. A solder fillet at the exposed copper edge cannot be guaranteed and is not required to ensure a proper bottom solder connection.

***1.6A Linear Li-Ion Battery Charger in a 3x3 TDFN Package***

Copyright © 2012 Skyworks Solutions, Inc. All Rights Reserved.

Information in this document is provided in connection with Skyworks Solutions, Inc. ("Skyworks") products or services. These materials, including the information contained herein, are provided by Skyworks as a service to its customers and may be used for informational purposes only by the customer. Skyworks assumes no responsibility for errors or omissions in these materials or the information contained herein. Skyworks may change its documentation, products, services, specifications or product descriptions at any time, without notice. Skyworks makes no commitment to update the materials or information and shall have no responsibility whatsoever for conflicts, incompatibilities, or other difficulties arising from any future changes.

No license, whether express, implied, by estoppel or otherwise, is granted to any intellectual property rights by this document. Skyworks assumes no liability for any materials, products or information provided hereunder, including the sale, distribution, reproduction or use of Skyworks products, information or materials, except as may be provided in Skyworks Terms and Conditions of Sale.

THE MATERIALS, PRODUCTS AND INFORMATION ARE PROVIDED "AS IS" WITHOUT WARRANTY OF ANY KIND, WHETHER EXPRESS, IMPLIED, STATUTORY, OR OTHERWISE, INCLUDING FITNESS FOR A PARTICULAR PURPOSE OR USE, MERCHANTABILITY, PERFORMANCE, QUALITY OR NON-INFRINGEMENT OF ANY INTELLECTUAL PROPERTY RIGHT; ALL SUCH WARRANTIES ARE HEREBY EXPRESSLY DISCLAIMED. SKYWORKS DOES NOT WARRANT THE ACCURACY OR COMPLETENESS OF THE INFORMATION, TEXT, GRAPHICS OR OTHER ITEMS CONTAINED WITHIN THESE MATERIALS. SKYWORKS SHALL NOT BE LIABLE FOR ANY DAMAGES, INCLUDING BUT NOT LIMITED TO ANY SPECIAL, INDIRECT, INCIDENTAL, STATUTORY, OR CONSEQUENTIAL DAMAGES, INCLUDING WITHOUT LIMITATION, LOST REVENUES OR LOST PROFITS THAT MAY RESULT FROM THE USE OF THE MATERIALS OR INFORMATION, WHETHER OR NOT THE RECIPIENT OF MATERIALS HAS BEEN ADVISED OF THE POSSIBILITY OF SUCH DAMAGE.

Skyworks products are not intended for use in medical, lifesaving or life-sustaining applications, or other equipment in which the failure of the Skyworks products could lead to personal injury, death, physical or environmental damage. Skyworks customers using or selling Skyworks products for use in such applications do so at their own risk and agree to fully indemnify Skyworks for any damages resulting from such improper use or sale.

Customers are responsible for their products and applications using Skyworks products, which may deviate from published specifications as a result of design defects, errors, or operation of products outside of published parameters or design specifications. Customers should include design and operating safeguards to minimize these and other risks. Skyworks assumes no liability for applications assistance, customer product design, or damage to any equipment resulting from the use of Skyworks products outside of stated published specifications or parameters.

Skyworks, the Skyworks symbol, and "Breakthrough Simplicity" are trademarks or registered trademarks of Skyworks Solutions, Inc., in the United States and other countries. Third-party brands and names are for identification purposes only, and are the property of their respective owners. Additional information, including relevant terms and conditions, posted at [www.skyworksinc.com](http://www.skyworksinc.com), are incorporated by reference.