

SECTION A-A
(VIEW FROM FRONT)

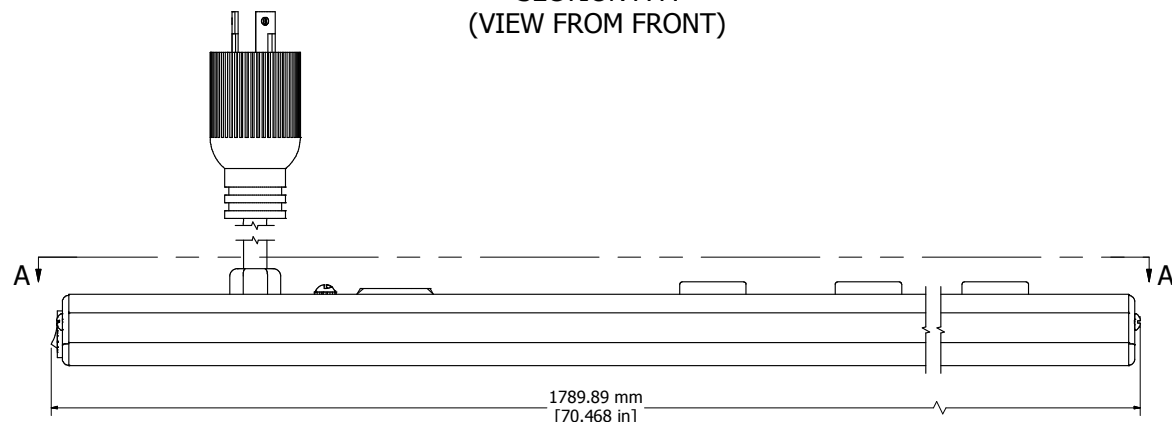

ASSEMBLY - VIEW FROM SIDE

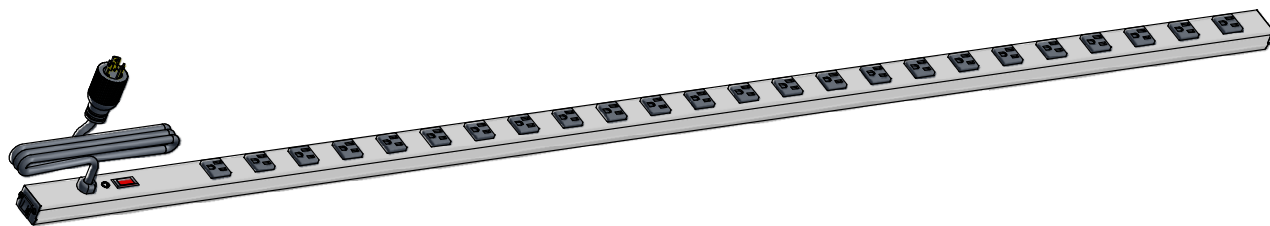

ISOMETRIC VIEW

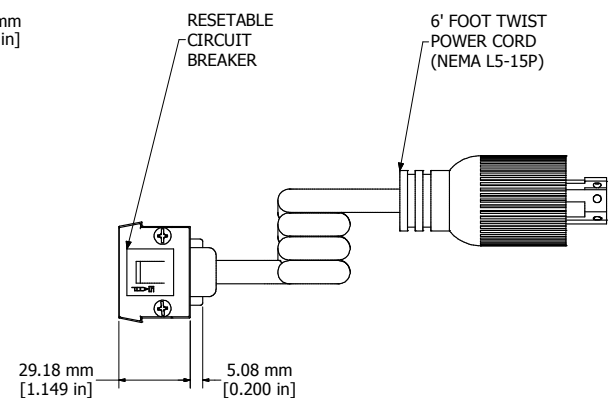

ASSEMBLY - VIEW FROM END

1587T24C1
Finish - Case - Anodized Aluminum Extrusion
Ends - ABS Plastic
Rated - 125 VAC, 60 Hz, 15 Amps
Approvals - CSA Certified Standards C22.2 (No. 21-95, 42-99)
- UL Listed Standard UL1363
Cord Length
1587T24C1 - 6' Foot Twist Power Cord (NEMA L5-15P)
1587T24D1 - 15' Foot Twist Power Cord (NEMA L5-15P)
Accessories Included
Mounting Bracket Kit with Hardware



**HAMMOND
MANUFACTURING™**

1587T24C1

www.hammondmfg.com