

Thunderbolt IGBT®

The Thunderbolt IGBT® is a new generation of high voltage power IGBTs. Using Non-Punch Through Technology, the Thunderbolt IGBT® offers superior ruggedness and ultrafast switching speed.

- Low Forward Voltage Drop
- High Freq. Switching to 150KHz
- Low Tail Current
- Ultra Low Leakage Current
- RBSOA and SCSOA Rated

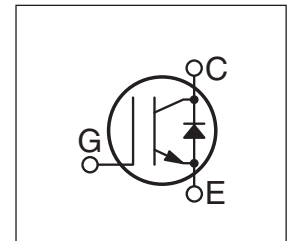
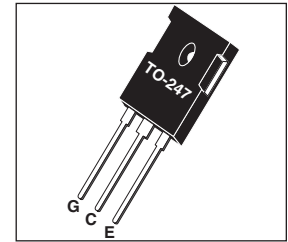

MAXIMUM RATINGS

All Ratings: $T_C = 25^\circ\text{C}$ unless otherwise specified.

Symbol	Parameter	APT20GT60BRDQ1(G)	UNIT
V_{CES}	Collector-Emitter Voltage	600	Volts
V_{GE}	Gate-Emitter Voltage	± 30	
I_{C1}	Continuous Collector Current @ $T_C = 25^\circ\text{C}$	43	Amps
I_{C2}	Continuous Collector Current @ $T_C = 110^\circ\text{C}$	20	
I_{CM}	Pulsed Collector Current ^① @ $T_C = 150^\circ\text{C}$	80	
SSOA	Switching Safe Operating Area @ $T_J = 150^\circ\text{C}$	80A @ 600V	
P_D	Total Power Dissipation	174	Watts
T_J, T_{STG}	Operating and Storage Junction Temperature Range	-55 to 150	$^\circ\text{C}$
T_L	Max. Lead Temp. for Soldering: 0.063" from Case for 10 Sec.	300	

STATIC ELECTRICAL CHARACTERISTICS

Symbol	Characteristic / Test Conditions	MIN	TYP	MAX	Units
$V_{(BR)CES}$	Collector-Emitter Breakdown Voltage ($V_{GE} = 0\text{V}, I_C = 0.5\text{mA}$)	600			Volts
$V_{GE(TH)}$	Gate Threshold Voltage ($V_{CE} = V_{GE}, I_C = 500\mu\text{A}, T_J = 25^\circ\text{C}$)	3	4	5	
$V_{CE(ON)}$	Collector-Emitter On Voltage ($V_{GE} = 15\text{V}, I_C = 20\text{A}, T_J = 25^\circ\text{C}$)	1.6	2.0	2.5	
	Collector-Emitter On Voltage ($V_{GE} = 15\text{V}, I_C = 20\text{A}, T_J = 125^\circ\text{C}$)		2.8		
I_{CES}	Collector Cut-off Current ($V_{CE} = 600\text{V}, V_{GE} = 0\text{V}, T_J = 25^\circ\text{C}$) ^②			50	μA
	Collector Cut-off Current ($V_{CE} = 600\text{V}, V_{GE} = 0\text{V}, T_J = 125^\circ\text{C}$) ^②			1000	
I_{GES}	Gate-Emitter Leakage Current ($V_{GE} = \pm 20\text{V}$)			± 100	nA



CAUTION: These Devices are Sensitive to Electrostatic Discharge. Proper Handling Procedures Should Be Followed.

DYNAMIC CHARACTERISTICS

APT20GT60BRDQ1(G)

Symbol	Characteristic	Test Conditions	MIN	TYP	MAX	UNIT
C_{ies}	Input Capacitance	Capacitance $V_{GE} = 0V, V_{CE} = 25V$ $f = 1 \text{ MHz}$		1100		pF
C_{oes}	Output Capacitance			107		
C_{res}	Reverse Transfer Capacitance			63		
V_{GEP}	Gate-to-Emitter Plateau Voltage	Gate Charge		7.5		V
Q_g	Total Gate Charge ^③	$V_{GE} = 15V$		100		nC
Q_{ge}	Gate-Emitter Charge	$V_{CE} = 300V$		7		
Q_{gc}	Gate-Collector ("Miller") Charge	$I_C = 20A$		43		
SSOA	Switching Safe Operating Area	$T_J = 150^\circ C, R_G = 5\Omega, V_{GE} = 15V, L = 100\mu H, V_{CE} = 600V$	80			A
$t_{d(on)}$	Turn-on Delay Time	Inductive Switching (25°C) $V_{CC} = 400V$ $V_{GE} = 15V$ $I_C = 20A$ $R_G = 5\Omega$ $T_J = +25^\circ C$		8		ns
t_r	Current Rise Time			9		
$t_{d(off)}$	Turn-off Delay Time			80		
t_f	Current Fall Time			39		μJ
E_{on1}	Turn-on Switching Energy ^④			215		
E_{on2}	Turn-on Switching Energy (Diode) ^⑤			210		
E_{off}	Turn-off Switching Energy ^⑥		245			
$t_{d(on)}$	Turn-on Delay Time	Inductive Switching (125°C) $V_{CC} = 400V$ $V_{GE} = 15V$ $I_C = 20A$ $R_G = 5\Omega$ $T_J = +125^\circ C$		8		ns
t_r	Current Rise Time			9		
$t_{d(off)}$	Turn-off Delay Time			100		
t_f	Current Fall Time			60		μJ
E_{on1}	Turn-on Switching Energy ^④			215		
E_{on2}	Turn-on Switching Energy (Diode) ^⑤			375		
E_{off}	Turn-off Switching Energy ^⑥		395			

THERMAL AND MECHANICAL CHARACTERISTICS

Symbol	Characteristic	MIN	TYP	MAX	UNIT
$R_{\theta JC}$	Junction to Case (IGBT)			.72	°C/W
$R_{\theta JC}$	Junction to Case (DIODE)			1.35	
W_T	Package Weight		5.9		gm

① Repetitive Rating: Pulse width limited by maximum junction temperature.

② For Combi devices, I_{ces} includes both IGBT and FRED leakages

③ See MIL-STD-750 Method 3471.

④ E_{on1} is the clamped inductive turn-on-energy of the IGBT only, without the effect of a commutating diode reverse recovery current adding to the IGBT turn-on loss. (See Figure 24.)

⑤ E_{on2} is the clamped inductive turn-on energy that includes a commutating diode reverse recovery current in the IGBT turn-on switching loss. (See Figures 21, 22.)

⑥ E_{off} is the clamped inductive turn-off energy measured in accordance with JEDEC standard JESD24-1. (See Figures 21, 23.)

APT Reserves the right to change, without notice, the specifications and information contained herein.

TYPICAL PERFORMANCE CURVES

APT20GT60BRDQ1(G)

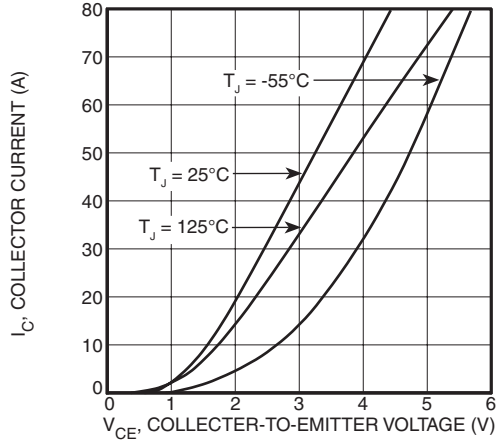

FIGURE 1, Output Characteristics ($T_J = 25^\circ\text{C}$)

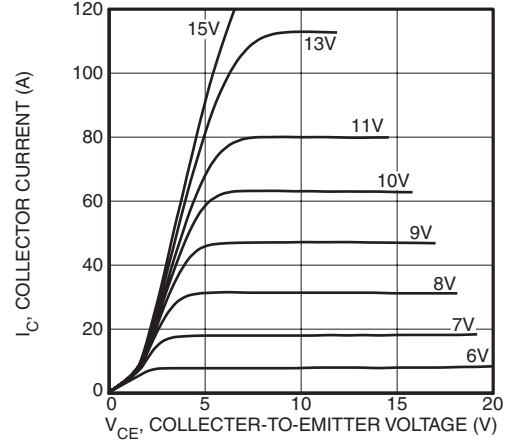

FIGURE 2, Output Characteristics ($T_J = 125^\circ\text{C}$)

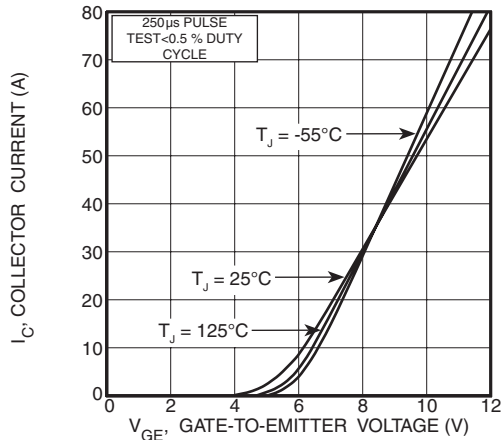

FIGURE 3, Transfer Characteristics

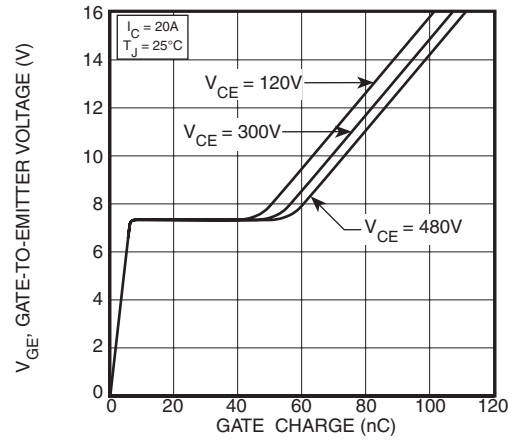

FIGURE 4, Gate Charge

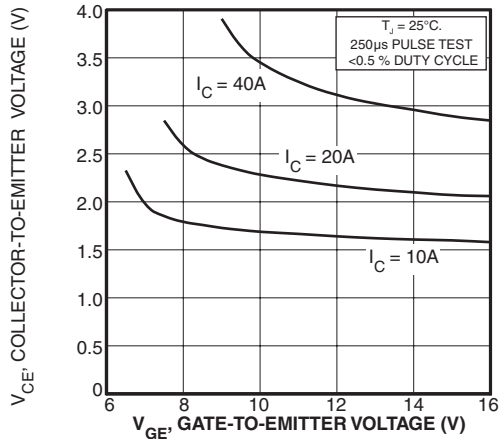

FIGURE 5, On State Voltage vs Gate-to-Emitter Voltage

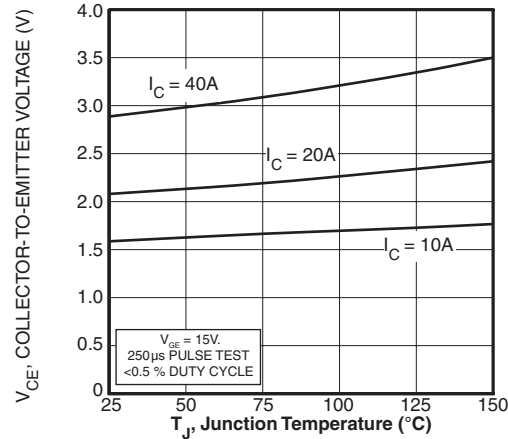

FIGURE 6, On State Voltage vs Junction Temperature

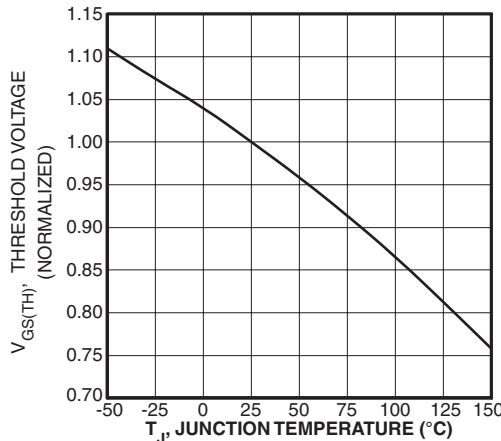

FIGURE 7, Threshold Voltage vs. Junction Temperature

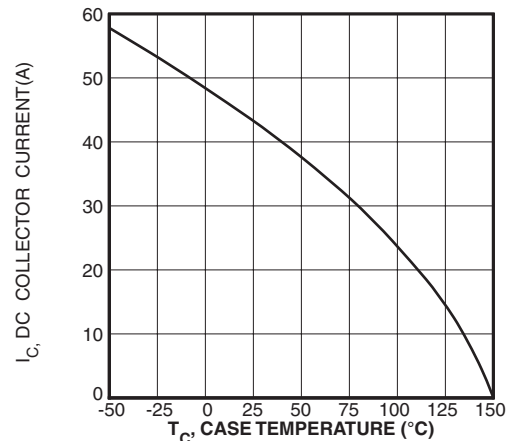

FIGURE 8, DC Collector Current vs Case Temperature

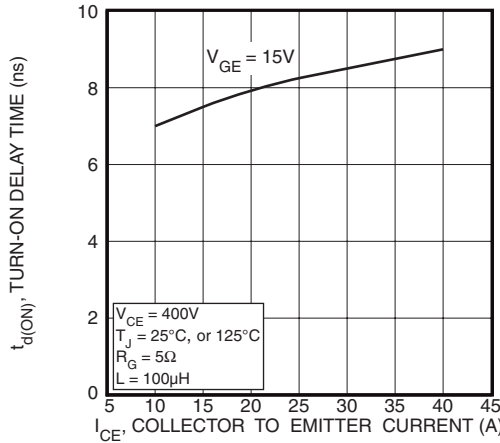

FIGURE 9, Turn-On Delay Time vs Collector Current

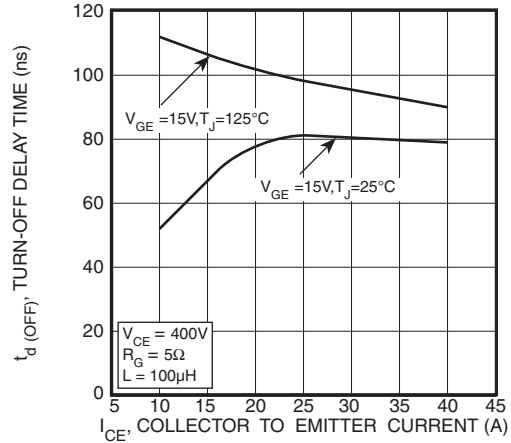

FIGURE 10, Turn-Off Delay Time vs Collector Current

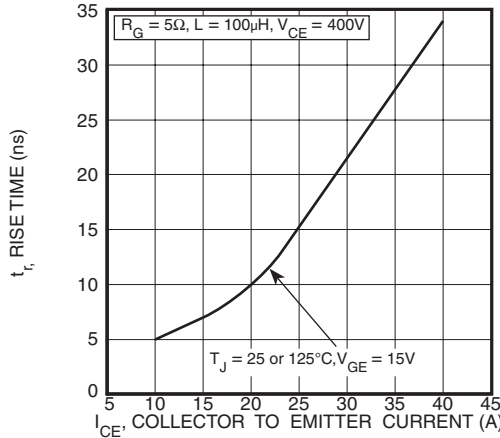

FIGURE 11, Current Rise Time vs Collector Current

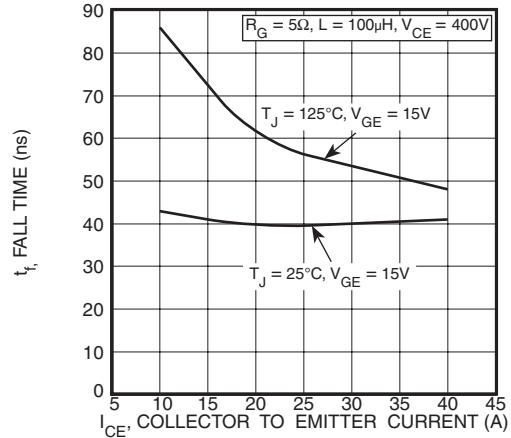

FIGURE 12, Current Fall Time vs Collector Current

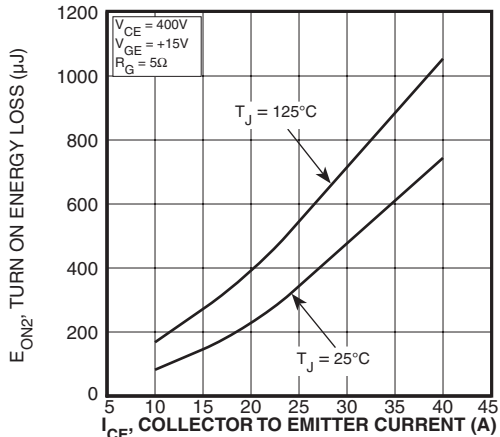

FIGURE 13, Turn-On Energy Loss vs Collector Current

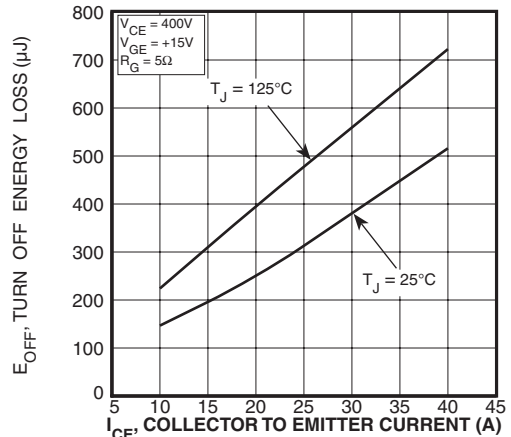

FIGURE 14, Turn Off Energy Loss vs Collector Current

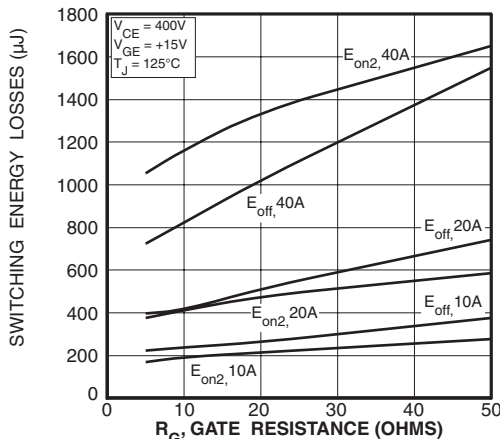

FIGURE 15, Switching Energy Losses vs. Gate Resistance

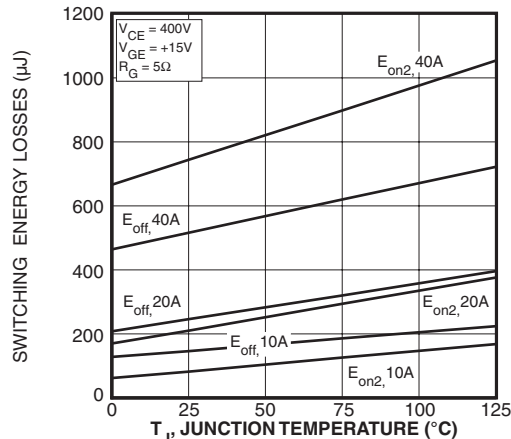

FIGURE 16, Switching Energy Losses vs Junction Temperature

TYPICAL PERFORMANCE CURVES

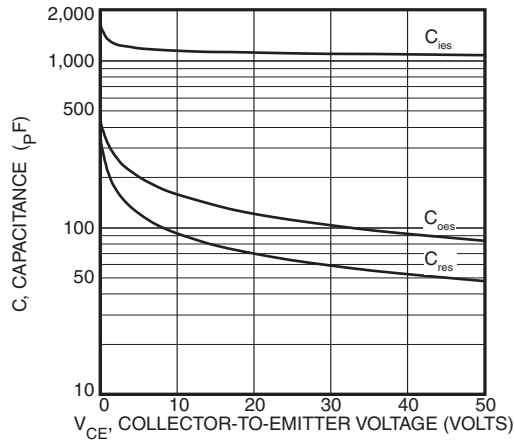

Figure 17, Capacitance vs Collector-To-Emitter Voltage

APT20GT60BRDQ1(G)

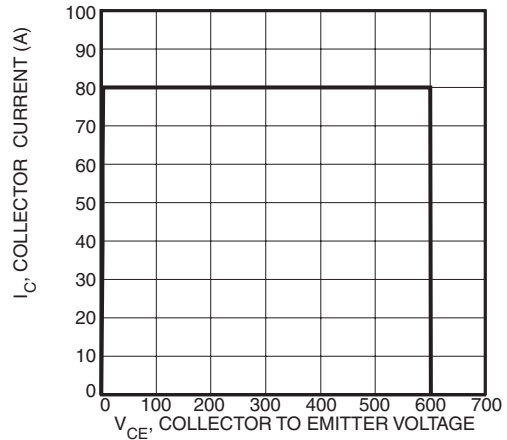

Figure 18, Minimum Switching Safe Operating Area

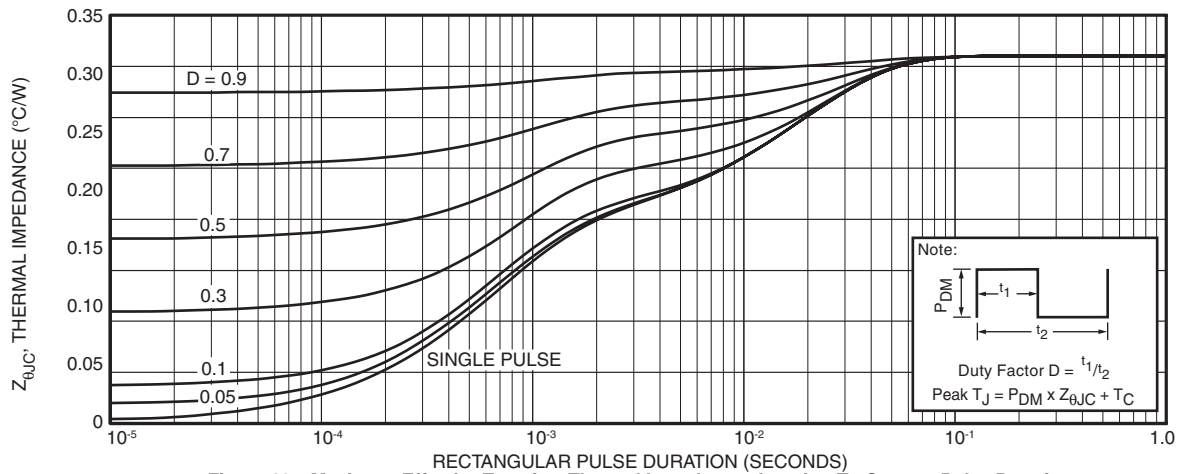

Figure 19a, Maximum Effective Transient Thermal Impedance, Junction-To-Case vs Pulse Duration

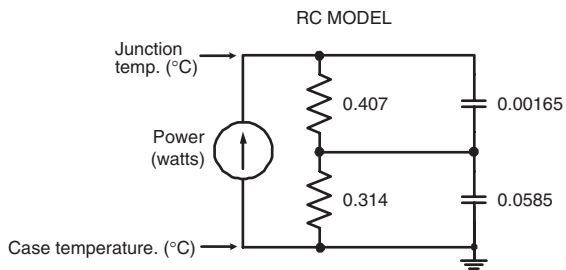

FIGURE 19b, TRANSIENT THERMAL IMPEDANCE MODEL

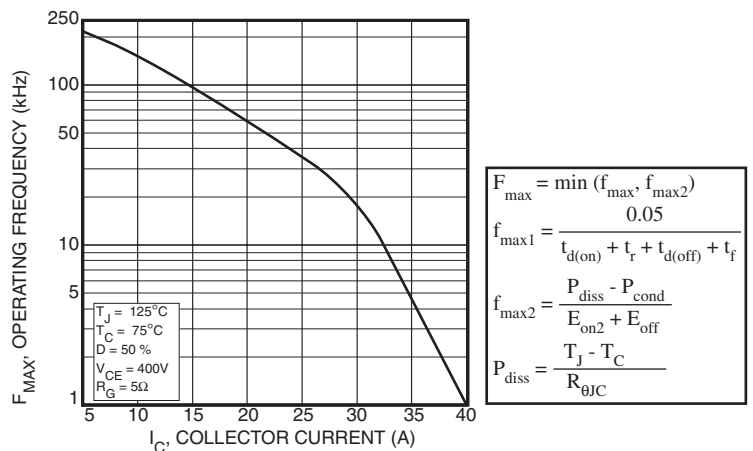

Figure 20, Operating Frequency vs Collector Current

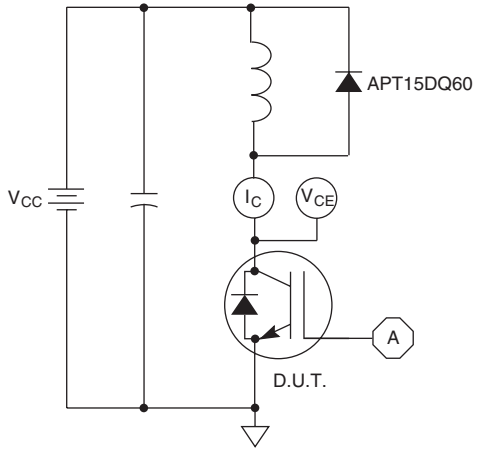

Figure 21, Inductive Switching Test Circuit

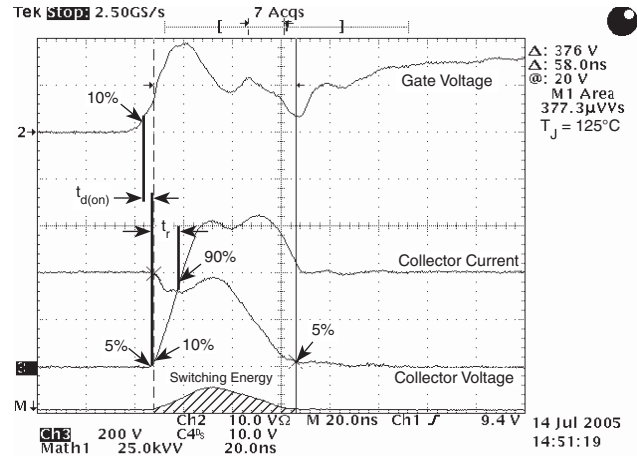

Figure 22, Turn-on Switching Waveforms and Definitions

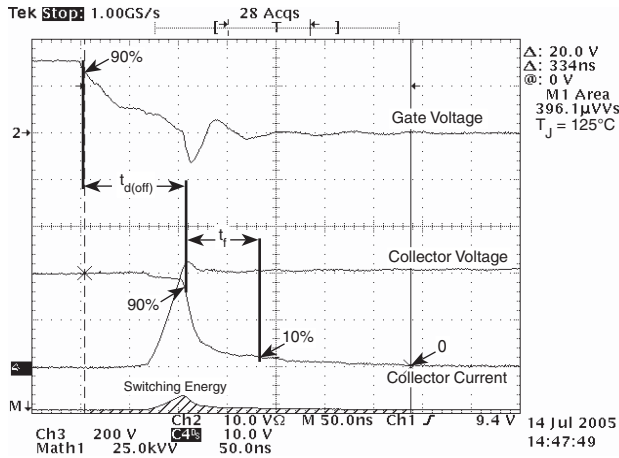

Figure 23, Turn-off Switching Waveforms and Definitions

ULTRAFAST SOFT RECOVERY ANTI-PARALLEL DIODE

MAXIMUM RATINGS

All Ratings: $T_C = 25^\circ\text{C}$ unless otherwise specified.

Symbol	Characteristic / Test Conditions	APT20GT60BRDQ1(G)		UNIT
$I_{F(AV)}$	Maximum Average Forward Current ($T_C = 129^\circ\text{C}$, Duty Cycle = 0.5)	15		Amps
$I_{F(RMS)}$	RMS Forward Current (Square wave, 50% duty)	30		
I_{FSM}	Non-Repetitive Forward Surge Current ($T_J = 45^\circ\text{C}$, 8.3ms)	110		

STATIC ELECTRICAL CHARACTERISTICS

Symbol	Characteristic / Test Conditions	MIN	TYP	MAX	UNIT
V_F	Forward Voltage		$I_F = 20\text{A}$	2.18	Volts
			$I_F = 40\text{A}$	2.76	
			$I_F = 20\text{A}, T_J = 125^\circ\text{C}$	1.75	

DYNAMIC CHARACTERISTICS

Symbol	Characteristic	Test Conditions	MIN	TYP	MAX	UNIT
t_{rr}	Reverse Recovery Time	$I_F = 1\text{A}, di_F/dt = -100\text{A}/\mu\text{s}, V_R = 30\text{V}, T_J = 25^\circ\text{C}$	-	15		ns
t_{rr}	Reverse Recovery Time	$I_F = 15\text{A}, di_F/dt = -200\text{A}/\mu\text{s}, V_R = 400\text{V}, T_C = 25^\circ\text{C}$	-	19		
Q_{rr}	Reverse Recovery Charge		-	21		nC
I_{RRM}	Maximum Reverse Recovery Current		-	2	-	Amps
t_{rr}	Reverse Recovery Time	$I_F = 15\text{A}, di_F/dt = -200\text{A}/\mu\text{s}, V_R = 400\text{V}, T_C = 125^\circ\text{C}$	-	105		ns
Q_{rr}	Reverse Recovery Charge		-	250		nC
I_{RRM}	Maximum Reverse Recovery Current		-	5	-	Amps
t_{rr}	Reverse Recovery Time	$I_F = 15\text{A}, di_F/dt = -1000\text{A}/\mu\text{s}, V_R = 400\text{V}, T_C = 125^\circ\text{C}$	-	55		ns
Q_{rr}	Reverse Recovery Charge		-	420		nC
I_{RRM}	Maximum Reverse Recovery Current		-	15		Amps

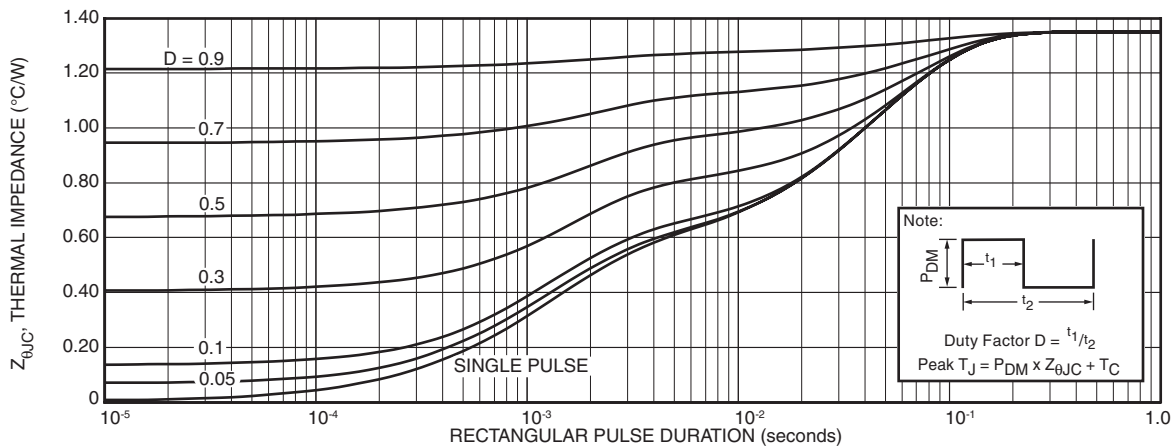

FIGURE 24a. MAXIMUM EFFECTIVE TRANSIENT THERMAL IMPEDANCE, JUNCTION-TO-CASE vs. PULSE DURATION

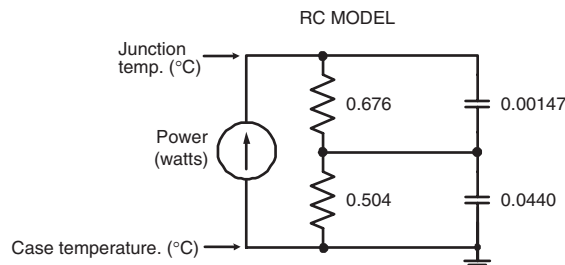

FIGURE 24b. TRANSIENT THERMAL IMPEDANCE MODEL

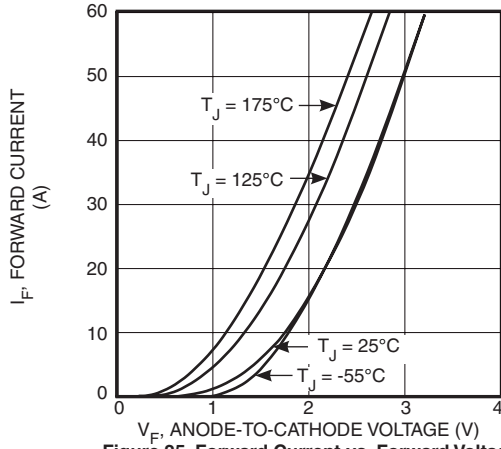

Figure 25. Forward Current vs. Forward Voltage

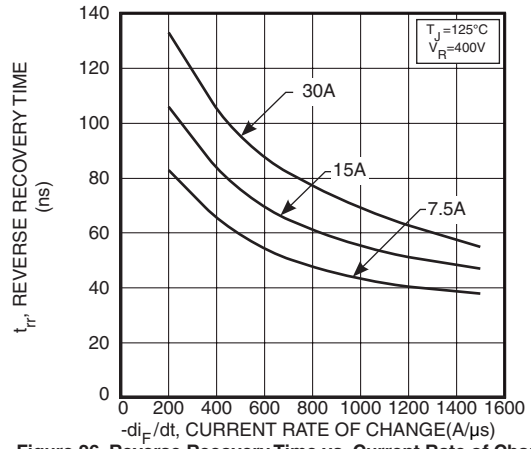

Figure 26. Reverse Recovery Time vs. Current Rate of Change

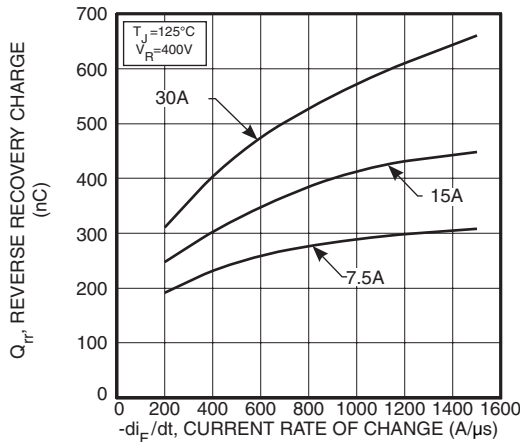

Figure 27. Reverse Recovery Charge vs. Current Rate of Change

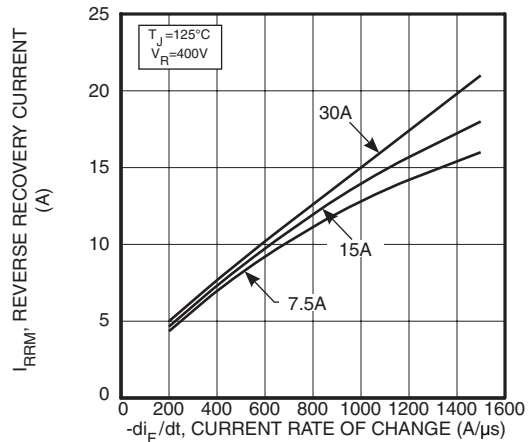

Figure 28. Reverse Recovery Current vs. Current Rate of Change

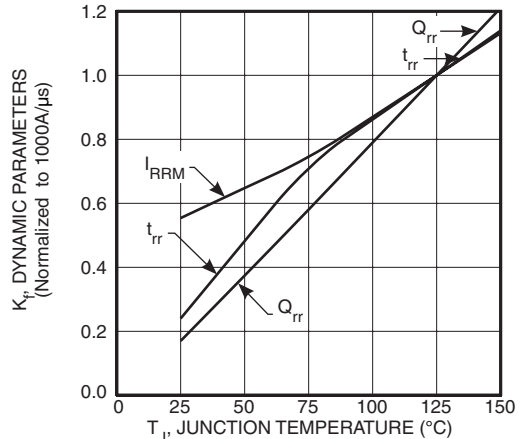

Figure 29. Dynamic Parameters vs. Junction Temperature

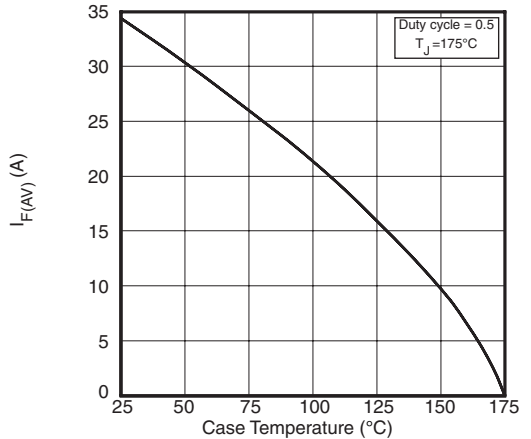

Figure 30. Maximum Average Forward Current vs. Case Temperature

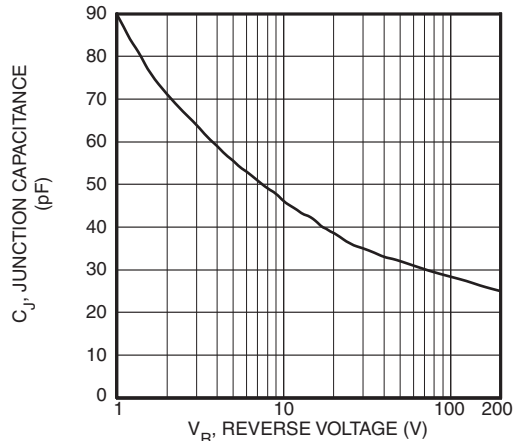

Figure 31. Junction Capacitance vs. Reverse Voltage

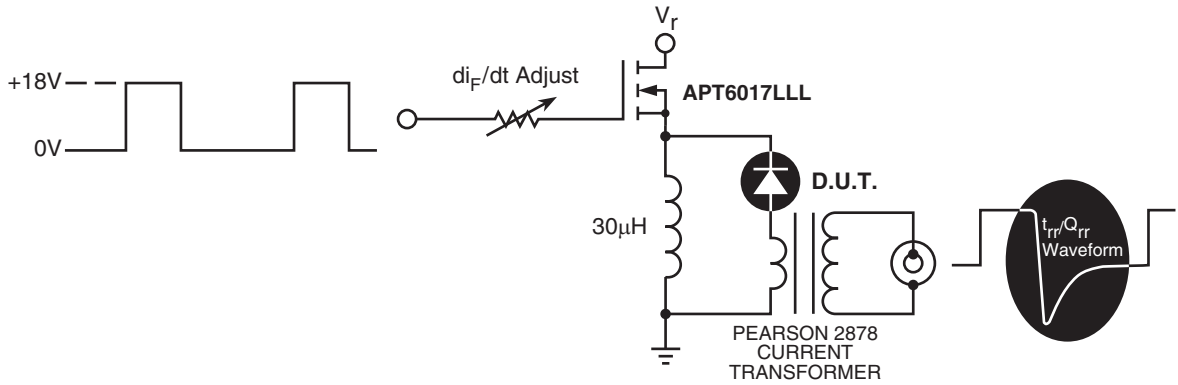

Figure 32. Diode Test Circuit

- 1 I_F - Forward Conduction Current
- 2 di_F/dt - Rate of Diode Current Change Through Zero Crossing.
- 3 I_{RRM} - Maximum Reverse Recovery Current.
- 4 t_{rr} - Reverse Recovery Time, measured from zero crossing where diode current goes from positive to negative, to the point at which the straight line through I_{RRM} and $0.25 \cdot I_{RRM}$ passes through zero.
- 5 Q_{rr} - Area Under the Curve Defined by I_{RRM} and t_{rr} .

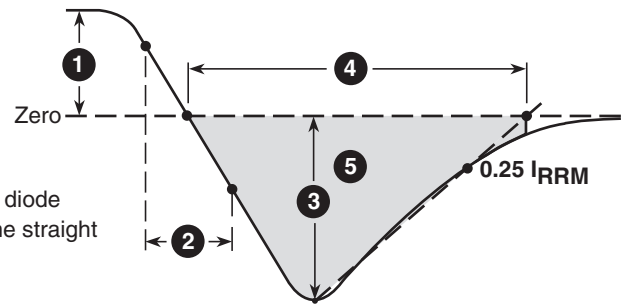
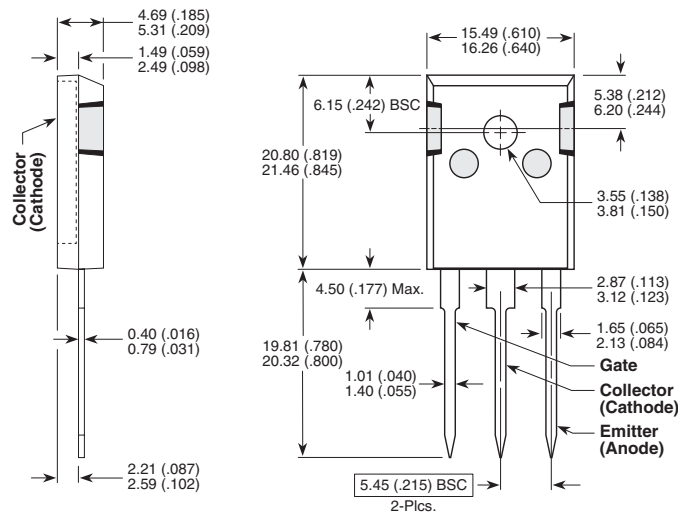

Figure 33, Diode Reverse Recovery Waveform and Definitions

TO-247 Package Outline

ⓔ1 SAC: Tin, Silver, Copper



Dimensions in Millimeters and (Inches)

APT's products are covered by one or more of U.S. patents 4,895,810 5,045,903 5,089,434 5,182,234 5,019,522 5,262,336 6,503,786 5,256,583 4,748,103 5,283,202 5,231,474 5,434,095 5,528,058 and foreign patents. US and Foreign patents pending. All Rights Reserved.