



# **VINCULUM**

BINDING USB TECHNOLOGIES

**Future Technology Devices International Ltd.**

**V2-EVAL**

**Vinculum II Evaluation Board**

**Datasheet**

**Document Reference No.: FT\_000247**

**Version 2.0**

**Issue Date: 2010-07-29**

**Future Technology Devices International Ltd (FTDI)**

**Unit 1, 2 Seaward Place, Centurion Business Park, Glasgow, G41 1HH, United Kingdom**

**Tel.: +44 (0) 141 429 2777 Fax: + 44 (0) 141 429 2758**

**E-Mail (Support): [support1@ftdichip.com](mailto:support1@ftdichip.com)**

**Web: <http://www.vinculum.com>**

Neither the whole nor any part of the information contained in, or the product described in this manual, may be adapted or reproduced in any material or electronic form without the prior written consent of the copyright holder. This product and its documentation are supplied on an as-is basis and no warranty as to their suitability for any particular purpose is either made or implied. Future Technology Devices International Ltd will not accept any claim for damages howsoever arising as a result of use or failure of this product. Your statutory rights are not affected. This product or any variant of it is not intended for use in any medical appliance, device or system in which the failure of the product might reasonably be expected to result in personal injury. This document provides preliminary information that may be subject to change without notice. No freedom to use patents or other intellectual property rights is implied by the publication of this document. Future Technology Devices International Ltd, Unit 1, 2 Seaward Place, Centurion Business Park, Glasgow, G41 1HH, United Kingdom. Scotland Registered Number: SC136640

## Table of Contents

<b>1</b>	<b>Introduction .....</b>	<b>3</b>
1.1	Handling the board .....	3
1.2	Environmental requirements.....	3
1.3	Part Numbers.....	4
1.4	References .....	4
1.5	Acronyms and Abbreviations.....	5
<b>2</b>	<b>Board Description.....</b>	<b>6</b>
2.1	V2-EVAL Board Features .....	6
2.2	Specifications.....	6
<b>3</b>	<b>V2-Eval Board Components and Interfaces .....</b>	<b>7</b>
3.1	Block Diagram.....	8
3.1.1	Components. ....	9
3.1.2	Interfaces.....	10
<b>4</b>	<b>Initial Board Set-up &amp; Test.....</b>	<b>11</b>
4.1	Installing VNC2 Daughterboard .....	11
4.2	Testing the board.....	12
<b>5</b>	<b>Detailed Description of Board Components. ....</b>	<b>13</b>
5.1	Power Select Jumper JP6.....	13
5.2	<b>GPIO BUS Connectors .....</b>	<b>14</b>
5.2.1	GPIO [0:7] Connector CN3 .....	14
5.2.2	GPIO [8:15] Connector CN4.....	15
5.2.3	GPIO [16:23] Connector CN5.....	16
5.2.4	GPIO [24:31] Connector CN6.....	17
5.2.5	GPIO [32:39] Connector CN7.....	18
5.2.6	GPIO [40:43] Connector CN8.....	19
5.3	<b>SPI Connector C9 .....</b>	<b>20</b>
5.4	<b>UART Interface Connector C10.....</b>	<b>21</b>
5.5	<b>FIFO Interface Connector CN11 .....</b>	<b>22</b>
5.6	<b>Prototyping area .....</b>	<b>23</b>
5.7	<b>USB1 interface CN1 .....</b>	<b>26</b>
5.8	<b>USB2 interface CN2.....</b>	<b>27</b>
5.9	<b>VNC1L Interface Mode Select / GPIO Jumpers JP1, JP2.....</b>	<b>28</b>
5.10	<b>User LEDs. LED3 – LED6.....</b>	<b>29</b>

5.11	LED enable/disable jumpers JP10 – JP14. ....	30
5.12	User push button switches.....	30
5.13	Host USB power jumpers JP4, JP5. ....	31
5.14	Remote Wakeup jumper JP3. ....	32
5.15	Reset Push-button Switch.....	33
5.16	'PROG' LED.....	33
5.17	VNC2 Daughterboard Connector – J1 .....	34
5.18	VNC2 Daughterboard Connector – J2 .....	35
5.19	VNC2 Daughterboard Connector – J3 .....	36
5.20	VNC2 Daughterboard Connector – J4 .....	37
6	FT4232H Configuration .....	38
6.1	UART Interface .....	39
6.2	Debug Interface – UART Mode .....	40
6.3	UART 'Spy' Interface.....	40
6.4	Device Control – Bit Bang Mode .....	40
7	Connecting to a PC Host.....	41
7.1	Driver Installation.....	41
8	V2-EVAL Software .....	45
8.1	V2-EVAL Terminal Installation .....	45
8.2	Using V2-EVAL Terminal .....	46
9	Board Schematics.....	49
9.1	V2-EVAL Board Schematics .....	50
9.2	VNC2 Daughterboard - 32-pin QFN Schematic .....	55
9.3	VNC2 Daughterboard - 48-pin QFN Schematic .....	56
9.4	VNC2 Daughterboard - 64-pin QFN Schematic .....	57
10	V2-EVAL Board Assembly Drawing .....	58
	Contact Information.....	59
	Appendix A – List of Figures and Tables .....	60
	List of Figures .....	60
	List of Tables.....	62
	Appendix B – Revision History .....	63

## 1 Introduction

The following document details the features and specifications of the V2-EVAL board. The V2-EVAL is a hardware platform designed to support easy evaluation of FTDI's Vinculum-II (VNC2) series of embedded USB host controller devices.

The V2-Eval kit includes the following hardware items as standard

- 1 x V2-Eval base board.
- 1 x 5V/1A mains adapter PSU – UK, US, European and Japanese versions available.
- 1 x USB A/B cable to connect to a host PC in programming / terminal emulation or debugging modes.
- 1 x USB gender changer for USB slave mode applications.

### NOTE:

**The V2-EVAL kit requires a VNC2 based daughterboard module to be installed into the V2-EVAL base board socket site, in order to enable development with the kit.**

Daughterboard modules are sold separately, with 3 versions available for 32-pin, 48-pin and 64-pin package devices. Daughterboard modules can be purchased from FTDI or via our website <http://www.ftdichip.com>.

### Before you proceed:

Please check that all the contents of the package are not damaged.

Ensure that your kit includes a proper version of the power supply, depending on the region where you live. Eval application software and project examples can be downloaded from: <http://www.ftdichip.com>

## 1.1 Handling the board

**Static discharge precaution** – Without proper anti-static handling the board can be damaged. Therefore, take anti-static precautions while handling the board.

## 1.2 Environmental requirements

The V2-Eval Board must be stored between -40°C and 80°C. The recommended operating temperature is between 0°C and 55°C

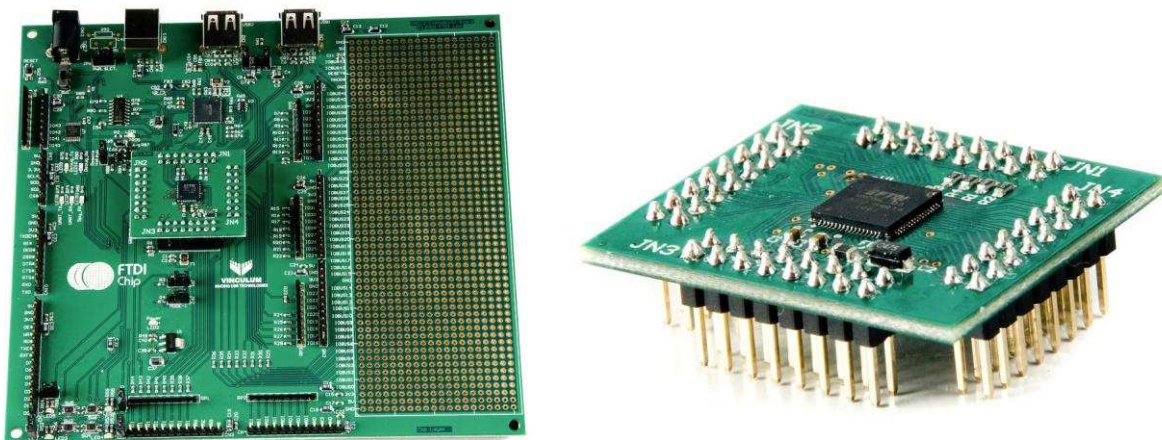

Figure 1.1 - V2-EVAL Motherboard(left) with Daughterboard Module(right)

### 1.3 Part Numbers

Part Number	Description
V2-EVAL	V2-EVAL kit with base board, power supply and cables.
V2-EVAL-EXT32	VNC2 daughterboard module with 32-pin QFN VNC2 device for use with V2-EVAL.
V2-EVAL-EXT48	VNC2 daughterboard module with 48-pin QFN VNC2 device for use with V2-EVAL.
V2-EVAL-EXT64	VNC2 daughterboard module with 64-pin QFN VNC2 device for use with V2-EVAL.

**Table 1.0 Part Numbers**

### 1.4 References

The document contains references to the following websites and documents. Links to most documents are available from the FTDI website, <http://www.ftdichip.com>.

Document Name	Description
1. FT_000138	Vinculum-II Embedded Dual USB Host Controller IC Data Sheet.
2. FT_000060	FT4232H Data Sheet.
3. AN_137	Vinculum-II IO Cell Description.
4. AN_138	Vinculum-II Debug Interface Description.
5. AN_139	Vinculum-II IO Mux Explained.
6. AN_140	Vinculum-II PWM Example.
7. FT_000006	Vinculum Firmware User Manual.
8. USB 2.0	Universal Serial Bus Specification Revision 2.0 USB Implementers Forum <a href="http://www.usb.org">http://www.usb.org</a> .

**Table 1.1 Document References**

## 1.5 Acronyms and Abbreviations

Terms	Description
FIFO	First In First Out.
GPIO	General Purpose Input Output.
I/O	Input / Output.
MISO	Master In Slave Out.
MOSI	Master Out Slave In.
SPI	Serial Peripheral Interface.
UART	Universal Asynchronous Receiver/Transmitter.
USB	Universal Serial Bus.
VNC2	Vinculum-II.

**Table 1.2 Acronyms and Abbreviations**

## 2 Board Description

V2-Eval Board is intended for use as a hardware platform to enable easy evaluation of FTDI's Vinculum-II VNC2 series of embedded USB Host / Slave controllers. The V2-Eval Board includes all the necessary components required by a user to begin developing USB Host / Slave system applications based on the VNC2 device.

### 2.1 V2-EVAL Board Features

- VNC2 – Embedded USB Host / Slave chip accessible via daughterboard.
- Selection of VNC2 daughterboards to support 32-pin, 48-pin and 64-pin QFN packages.
- Two USB type A connectors for connecting to USB slave peripherals.
- VNC2 IO port connectors grouped by port name/or function.
- FT42232H –USB to quad channel UART device for VNC2 programming & debug functions.
- One USB type B connector for connection to PC host via FT4232H.
- 4 User-programmable LEDs.
- 4 User-programmable push button switches.

### 2.2 Specifications

- Board supply voltage: 4.75V ... 5.25V.
- Board supply current: 60mA (with no USB devices on USB1 or USB2 port).
- IO connectors power output: 5V/150mA, 3.3V/150mA.
- Base board dimensions: 167mm x 156mm x 1.5mm (L x W x H).
- VNC2 daughterboard dimensions: 37.9mm x 32.48mm x 10.0mm (L x W x H).

### 3 V2-Eval Board Components and Interfaces

This chapter describes the operational and connectivity information for the V2-Eval board major components and interfaces.

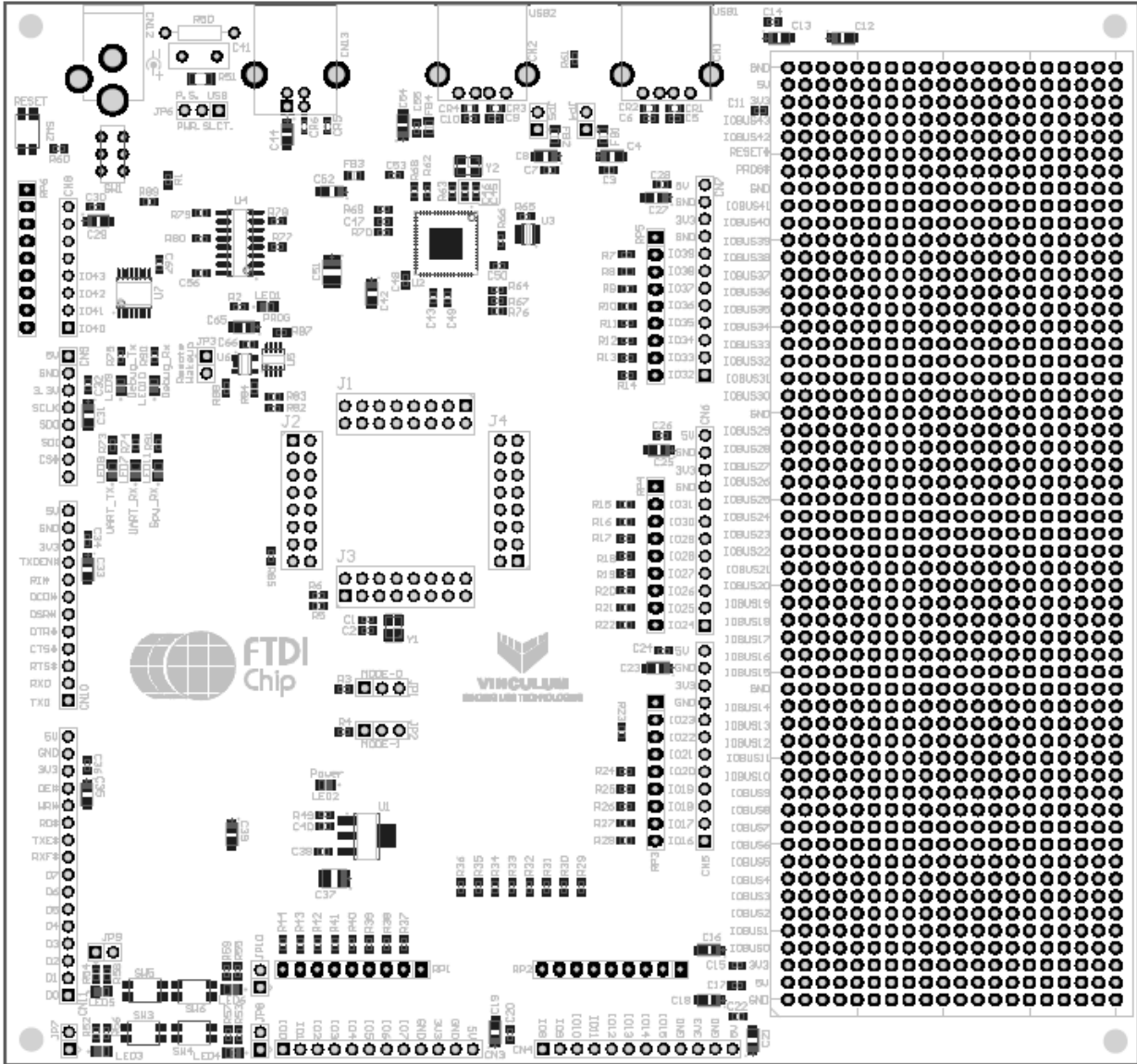

Figure 3.1 V2-EVAL Board Layout



### 3.1 Block Diagram

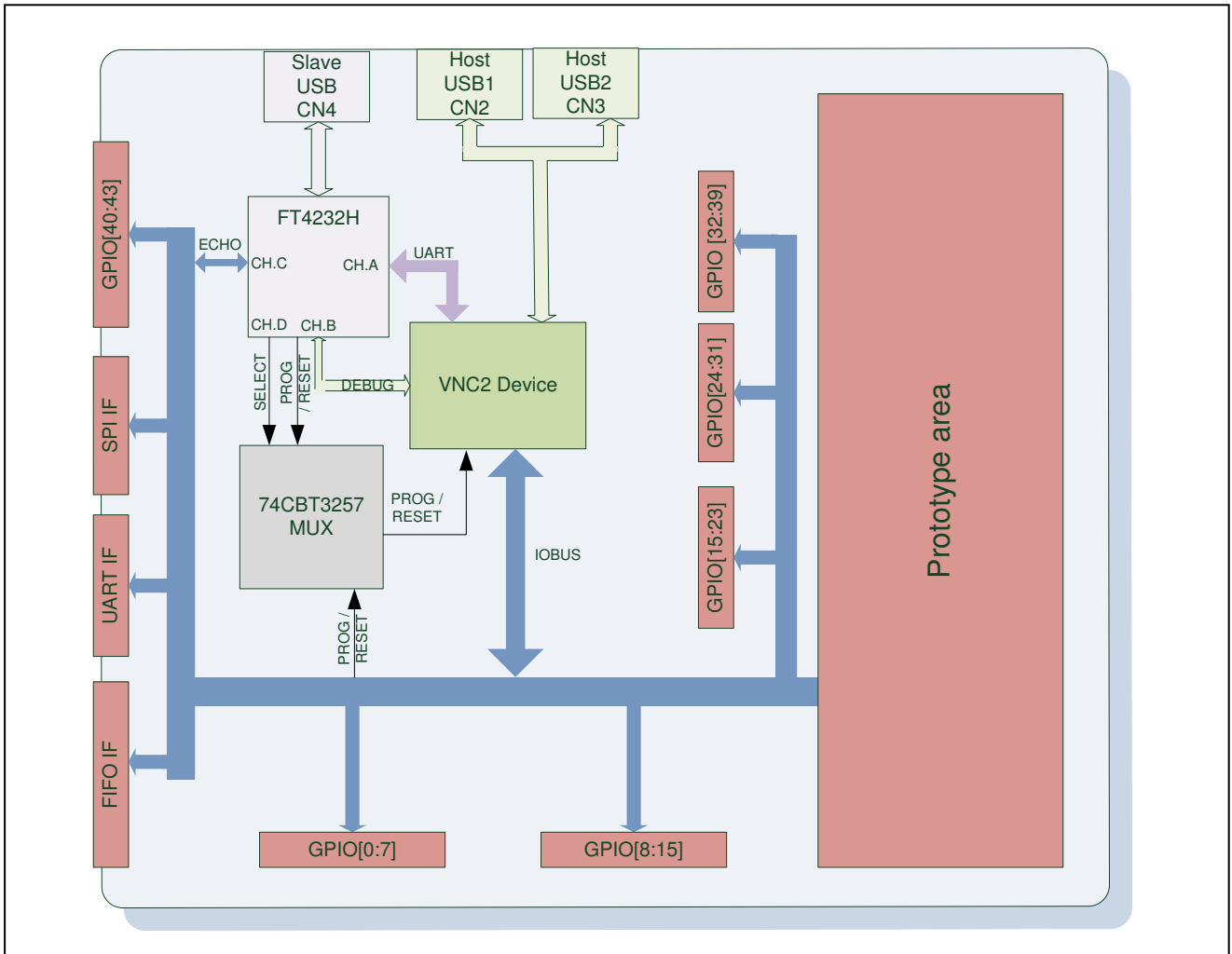

Figure 3.2 V2-EVAL Board Block Diagram

### 3.1.1 Components.

Component	Board designator	Description
USB-UART bridge	U2	FT4232H USB ⇔ Quad UART/FIFO device.
Configuration memory	U3	9356 Serial SPI EEPROM for FT4232H configuration data.
IO multiplexer	U4	74CBT3257 4-bit, 1to2, FET Multiplexer/Demultiplexer.
3.3V regulator	U1	AIC1735-33 Ultra low dropout 3.3V voltage regulator.
Dual port buffer	U5	SN74LVC2G125 dual port buffer used to convert bi-directional debug signal into separate TX and RX signals.
Inverter	U6	SN74LVC1G14 inverter device used to invert the TXDEN output from FT4232H to control output enable signal for dual port buffer.
12MHz crystal	Y2	12MHz crystal for FT4232H.
Single 5V DC power supply	CN12	Board adapter for included 5V DC power supply.
Power switch	SW1	Power On/Off switch.
Power source select	JP6	Power source selection jumper.
Reset button	SW2	Push-button switch for manual reset of VNC2 device.
Keyboard	SW3-SW6	Four user push-button switches.
User LEDs	LED3-LED6	Four green user LEDs.
PROG LED	LED1	Red LED.
Power LED	LED2	Green LED.
UART RX LED	LED7	Green LED.
UART TX LED	LED8	Red LED.
Debug TX	LED9	Red LED.
Debug RX	LED10	Green LED.
SPI_RX	LED11	Green LED.
LEDs enable jumpers	JP7-JP10	Enable/disable user-defined LEDs.
GPIO I/O Jumpers	JP1, JP2	GPIO I/O jumpers .
REMOTE WAKEUP	JP3	VNC2 remote wakeup jumper.
VBUS jumpers	JP4, JP5	USB1, USB2 power bus enable jumpers.

**Table 3.1 V2-Eval Board Components**

### 3.1.2 Interfaces.

Component	Board designator	Description
USB1, USB2 <sup>(1)</sup>	CN1, CN2	VNC2 USB host ports 1&2.
USB Type B	CN13	FT4232H USB Slave connection.
VNC2 Socket	J1 -J4	Daughterboard connectors for VNC2 Daughterboard.
SPI <sup>(2)</sup>	CN9	VNC2 SPI interface pins.
UART <sup>(2)</sup>	CN10	VNC2 UART interface pins.
FIFO <sup>(2)</sup>	CN11	VNC2 FIFO interface pins.
IOBUS[7..0] <sup>(2)</sup>	CN3	VNC2 IOBUS [7:0] port pins.
IOBUS[8..15] <sup>(2)</sup>	CN4	VNC2 IOBUS [8:15] port pins.
IOBUS[16..23] <sup>(2)</sup>	CN5	VNC2 IOBUS [16:23] port pins.
IOBUS[24..31] <sup>(2)</sup>	CN6	VNC2 IOBUS [24:31] port pins.
IOBUS[32..39] <sup>(2)</sup>	CN7	VNC2 IOBUS [32:39] port pins.
IOBUS[40..43] <sup>(2)</sup>	CN8	VNC2 IOBUS [40:43] port pins.
Prototyping area <sup>(2)</sup>	P1	All of VNC2 IO ports and PROG#, RESET# pins are brought on to this area.
<b>Notes</b> <b>(1) Gender changer required when ports are configured as slave ports by VNC2 firmware, to enable connection to a USB host port.</b> <b>(2) Those pins are shared between different areas and connectors on the board. You can use only one device at time connected to those pins.</b>		

Table 3.2 V2-Eval Board Interfaces

## 4 Initial Board Set-up & Test

### 4.1 Installing VNC2 Daughterboard

Prior to first powering the board, users must ensure that the daughterboard module hosting the VNC2 chip is correctly installed on to the main V2-Eval board. The V2-Eval board has 4 socket connectors, J1-J4, onto which the VNC2 daughterboard module is installed.

On the VNC2 daughterboard module, connector JN1 connects to corresponding socket J1, JN2 connects to socket J2, JN3 connects to socket J3 and JN4 connects to J4 on the V2-Eval board.

#### Warning!

**Please check that the VNC2 daughterboard module is correctly installed onto the V2-Eval board prior to power-up. Incorrect installation can cause the VNC2 to not function.**

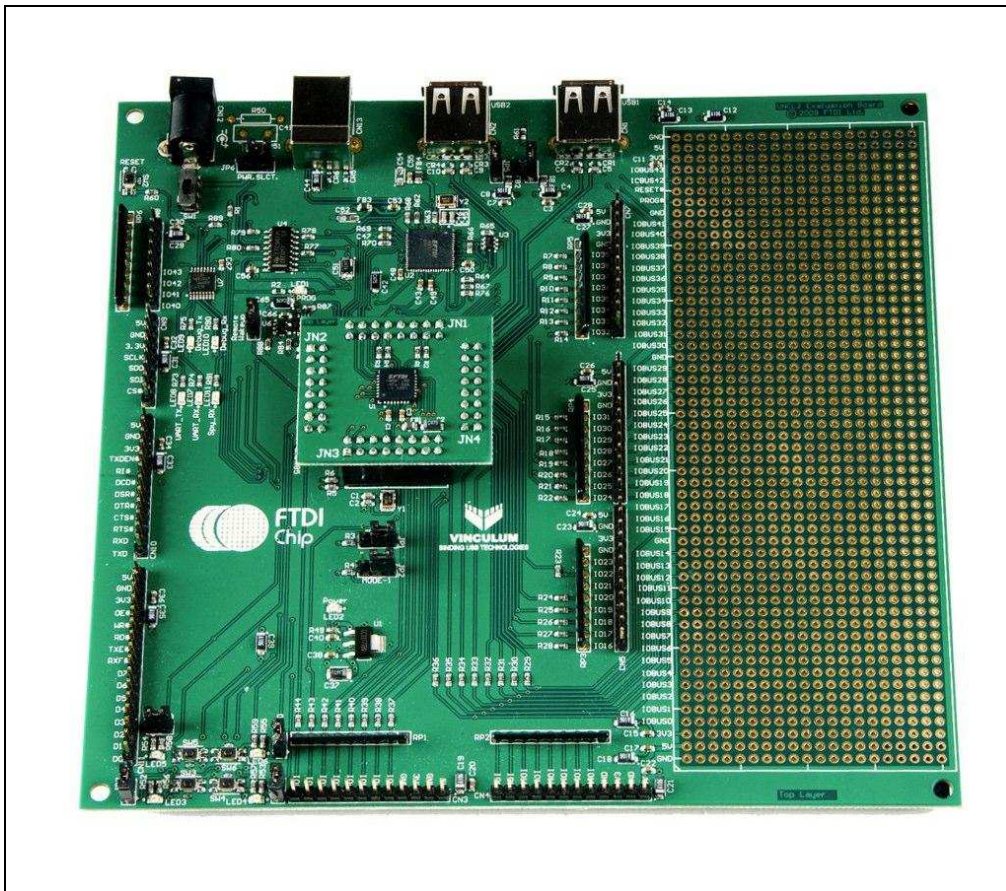

Figure 4.1 V2-EVAL Board with VNC2 Daughterboard Installed

## 4.2 Testing the board.

Ensure that the Power Select jumper JP6 is in 'P.S.' position (pins 2 & 3 shorted), to enable the board to be powered from the external power adapter.

Connect the 5V DC/1A power supply included in V2-Eval Kit to the external input power adapter connector (CN12), connect USB A/B cable to USB B connector (CN13) on V2-Eval Board and to a free USB port on host PC. Switch SW1 to the ON position (towards board edge). LED2 – POWER should now be on.

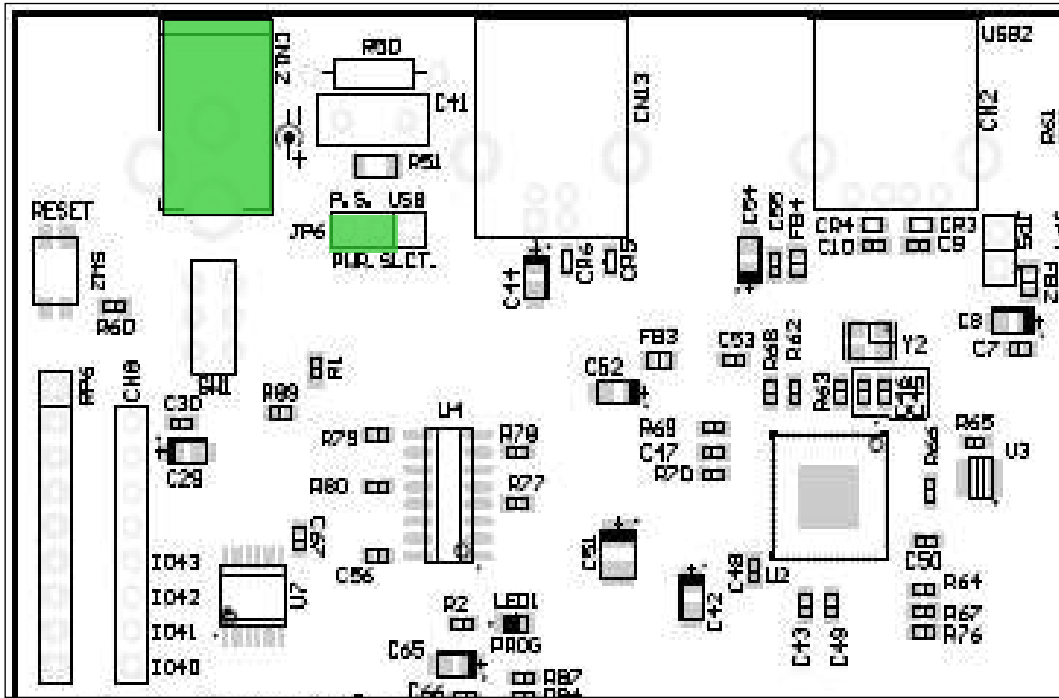

Figure 4.2 Power connector with Jumper JP6

The PCB circuitry will draw power either directly from the board 5V supply or from a 3.3V regulator that is powered by this 5V supply. This includes the VNC2 daughterboard module that is installed on the board. Upon power up, the power LED (LED2) will illuminate.

## 5 Detailed Description of Board Components.

### 5.1 Power Select Jumper JP6.

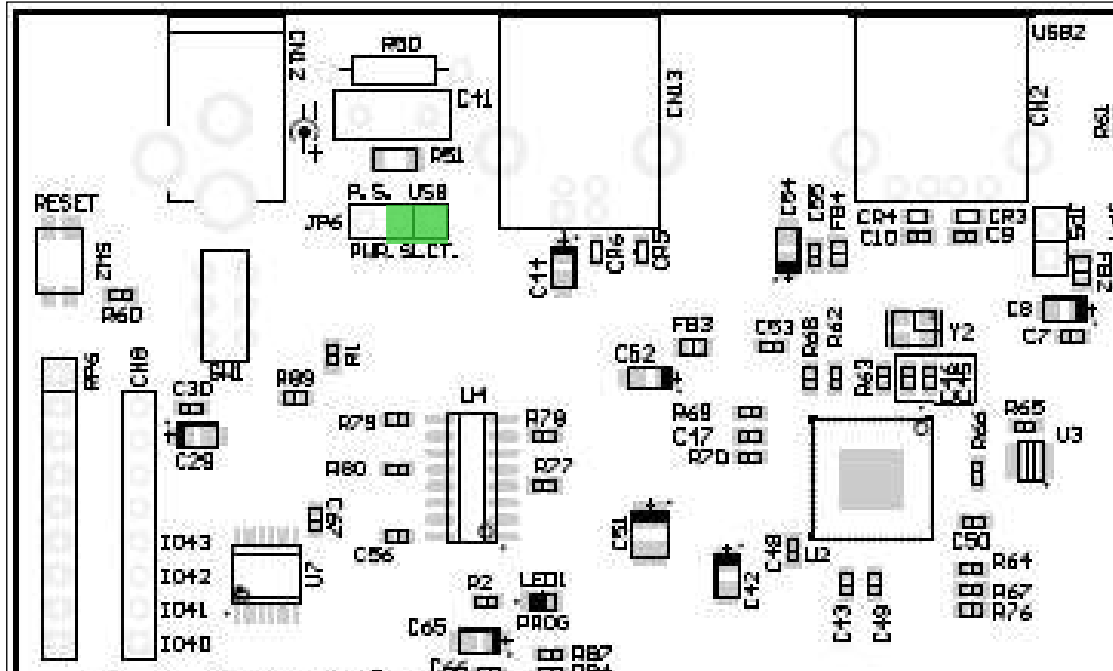

Figure 5.1 Power Select Jumper Configuration for USB Power

V2-Eval Board can draw its power either from the external 5V/1A DC Power Supply or from the USB interface when connected to a USB host via the B type connector (CN13). To enable USB power supply feature, switch the jumper JP6 to USB position, pins 1&2 shorted (pin 1 has a rectangle shaped pad on the bottom side of the board).

#### Warning!

**Please remember that every device connected to the PC through USB port can draw NO MORE than 500mA from the USB host PC 5V power bus.**

## 5.2 GPIO BUS Connectors

The V2-EVAL board features a set of 6 connectors providing access to GPIO capable pins on the VNC2 device. The GPIO pins are distributed across 6 connectors. The configuration of each connector is outlined in subsequent sections. Further each connector has a 5V and 3.3V power and GND pins.

### 5.2.1 GPIO [0:7] Connector CN3

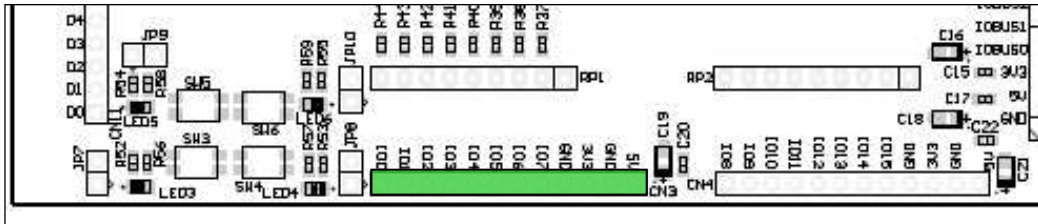

Figure 5.2 GPIO[0:7] Connector CN3

Signal name	Connector pin	VNC2 Pin No			IO type	Description
		32-PIN	48-PIN	64-PIN		
GPIO0 <sup>(3)</sup>	1	11	11	11	IO	GPIO data bit 0
GPIO1 <sup>(3)</sup>	2	12	12	12	IO	GPIO data bit 1
GPIO2 <sup>(3)</sup>	3	14	13	13	IO	GPIO data bit 2
GPIO3 <sup>(3)</sup>	4	15	14	14	IO	GPIO port, data bit 3
GPIO4 <sup>(3)</sup>	5	-	-	15	IO	GPIO port, data bit 4
GPIO5 <sup>(3)</sup>	6	-	-	16	IO	GPIO port, data bit 5
GPIO6 <sup>(3)</sup>	7	-	-	17	IO	GPIO port, data bit 6
GPIO7 <sup>(3)</sup>	8	-	-	18	IO	GPIO port, data bit 7
GND	9	-	-	-	-	Ground pin
3.3V <sup>(4)</sup>	10	-	-	-	-	3.3V power rail.
GND	11	-	-	-	-	Ground pin
5V <sup>(5)</sup>	12	-	-	-	-	5V power rail.

Notes:

- (3) All VNC2's IO pins can be driven from 3.3V LVTTTL TTL logic levels. The use of these pins for GPIO is set by the IOMUX on the VNC2 device. The pins are shared by other connectors on the board. Care should be taken to ensure that pins are not driven from other headers on the board.
- (4) This pin is connected to 3.3V regulator output. External device can draw no more than 100mA when board is powered from an external power supply and no more than 50mA when the board is powered from USB bus.
- (5) This pin is connected to the board's 5V power rail. External device can draw no more than 250mA when board is powered from an external power supply and no more than 50mA when the board is powered from USB bus.

Table 5.1 GPIO[0:7] port connector CN3

### 5.2.2 GPIO [8:15] Connector CN4

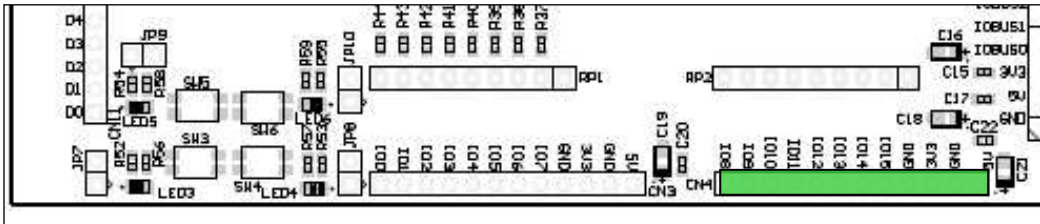

Figure 5.3 GPIO[8:15] Connector CN4

Signal name	Connector pin	VNC2 Pin No			IO type	Description
		32-PIN	48-PIN	64-PIN		
GPIO8 <sup>(6)</sup>	1	-	-	19	IO	GPIO port, data bit 8
GPIO9 <sup>(6)</sup>	2	-	-	20	IO	GPIO port, data bit 9
GPIO10 <sup>(6)</sup>	3	-	-	22	IO	GPIO port, data bit 10
GPIO11 <sup>(6)</sup>	4	-	-	23	IO	GPIO port, data bit 11
GPIO12 <sup>(6)</sup>	5	-	-	24	IO	GPIO port, data bit 12
GPIO13 <sup>(6)</sup>	6	-	-	25	IO	GPIO port, data bit 13
GPIO14 <sup>(6)</sup>	7	-	-	26	IO	GPIO port, data bit 14
GPIO15 <sup>(6)</sup>	8	-	-	27	IO	GPIO port, data bit 15
GND	9	-	-	-	-	Ground pin
3.3V <sup>(7)</sup>	10	-	-	-	-	3.3V power rail.
GND	11	-	-	-	-	Ground pin
5V <sup>(8)</sup>	12	-	-	-	-	5V power rail.

Notes:

- (6) All VNC2's IO pins can be driven from 3.3V LVTTTL TTL logic levels. The use of these pins for GPIO is set by the IOMUX on the VNC2 device. The pins are shared by other connectors on the board. Care should be taken to ensure that pins are not driven from other headers on the board.
- (7) This pin is connected to 3.3V regulator output. External device can draw no more than 100mA when board is powered from an external power supply and no more than 50mA when the board is powered from USB bus.
- (8) This pin is connected to the board's 5V power rail. External device can draw no more than 250mA when board is powered from an external power supply and no more than 50mA when the board is powered from USB bus.

Table 5.2 GPIO[8:15] connector CN4



### 5.2.3 GPIO [16:23] Connector CN5

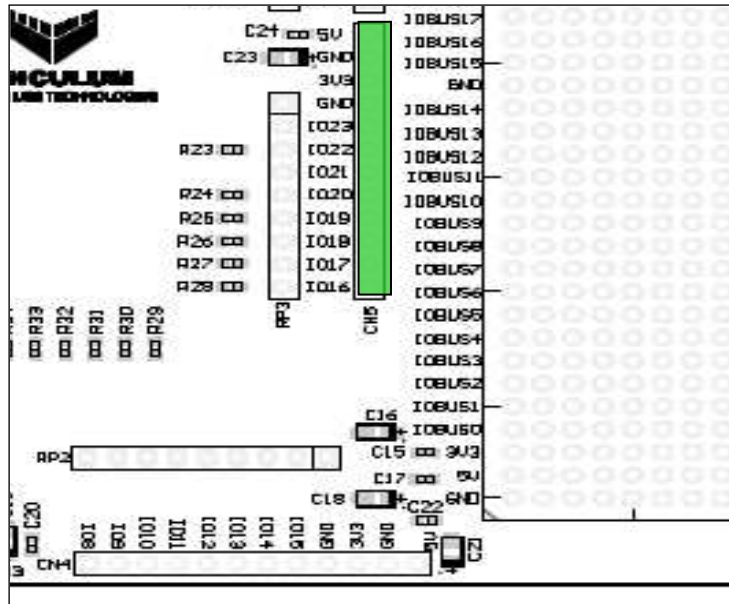

Figure 5.4 GPIO[16:23] Connector CN5

Signal name	Connector pin	VCN2 Pin No			IO type	Description
		32-PIN	48-PIN	64-PIN		
GPIO16 <sup>(9)</sup>	1	-	-	27	IO	GPIO port, data bit 16
GPIO17 <sup>(9)</sup>	2	-	46	28	IO	GPIO port, data bit 17
GPIO18 <sup>(9)</sup>	3	-	45	29	IO	GPIO port, data bit 18
GPIO19 <sup>(9)</sup>	4	-	48	31	IO	GPIO port, data bit19
GPIO20 <sup>(9)</sup>	5	23	31	32	IO	GPIO port, data bit 20
GPIO21 <sup>(9)</sup>	6	24 <sup>(10)</sup>	32 <sup>(10)</sup>	39	IO	GPIO port, data bit 21
GPIO22 <sup>(9)</sup>	7	25	33	40	IO	GPIO port, data bit 22
GPIO23 <sup>(9)</sup>	8	26 <sup>(10)</sup>	34 <sup>(10)</sup>	41	IO	GPIO port, data bit 23
GND	9	-	-	-	-	Ground pin
3.3V <sup>(11)</sup>	10	-	-	-	-	3.3V power rail.
GND	11	-	-	-	-	Ground pin
5V <sup>(12)</sup>	12	-	-	-	-	5V power rail.

Notes:

- (9) All VNC2's IO pins can be driven from 3.3V LVTTTL TTL logic levels. The use of these pins for GPIO is set by the IOMUX on the VNC2 device. The pins are shared by other connectors on the board. Care should be taken to ensure that pins are not driven from other headers on the board.
- (10) The following pins are only accessible on VNC2 when the onboard multiplexer select input is high. See section 6.4 for details.
- (11) This pin is connected to 3.3V regulator output. External device can draw no more than 100mA when board is powered from an external power supply and no more than 50mA when the board is powered from USB bus.
- (12) This pin is connected to the board's 5V power rail. External device can draw no more than 250mA when board is powered from an external power supply and no more than 50mA when the board is powered from USB bus.

Table 5.3 GPIO port connector CN5

### 5.2.4 GPIO [24:31] Connector CN6

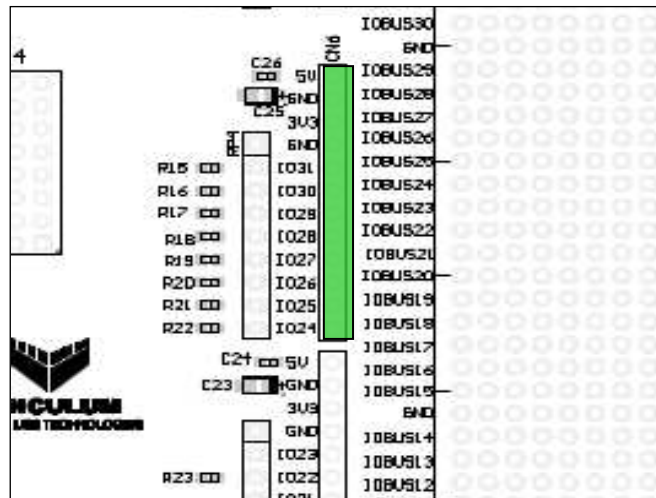

Figure 5.5 GPIO[24:31] Connector CN6

Signal name	Connector pin	VCN2 Pin No			IO type	Description
		32-PIN	48-PIN	64-PIN		
GPIO24 <sup>(13)</sup>	1	-	35	43	IO	GPIO port, data bit 24
GPIO25 <sup>(13)</sup>	2	-	36	44	IO	GPIO port, data bit 25
GPIO26 <sup>(13)</sup>	3	-	37	45	IO	GPIO port, data bit 26
GPIO27 <sup>(13)</sup>	4	-	38	46	IO	GPIO port, data bit 27
GPIO28 <sup>(13)</sup>	5	-	41	47	IO	GPIO port, data bit 28
GPIO29 <sup>(13)</sup>	6	-	42	48	IO	GPIO port, data bit 29
GPIO30 <sup>(13)</sup>	7	-	43	49	IO	GPIO port, data bit 30
GPIO31 <sup>(13)</sup>	8	-	44	50	IO	GPIO port, data bit 31
GND	9	-	-	-	-	Ground pin
3.3V <sup>(14)</sup>	10	-	-	-	-	3.3V power rail.
GND	11	-	-	-	-	Ground pin
5V <sup>(15)</sup>	12	-	-	-	-	5V power rail.

Notes:

- (13) All VNC2's IO pins can be driven from 3.3V LVTTTL TTL logic levels. The use of these pins for GPIO is set by the IOMUX on the VNC2 device. The pins are shared by other connectors on the board. Care should be taken to ensure that pins are not driven from other headers on the board.
- (14) This pin is connected to 3.3V regulator output. External device can draw no more than 100mA when board is powered from an external power supply and no more than 50mA when the board is powered from USB bus.
- (15) This pin is connected to the board's 5V power rail. External device can draw no more than 250mA when board is powered from power supply and no more than 50mA when the board is powered from USB bus.

Table 5.4 GPIO port connector CN6

### 5.2.5 GPIO [32:39] Connector CN7

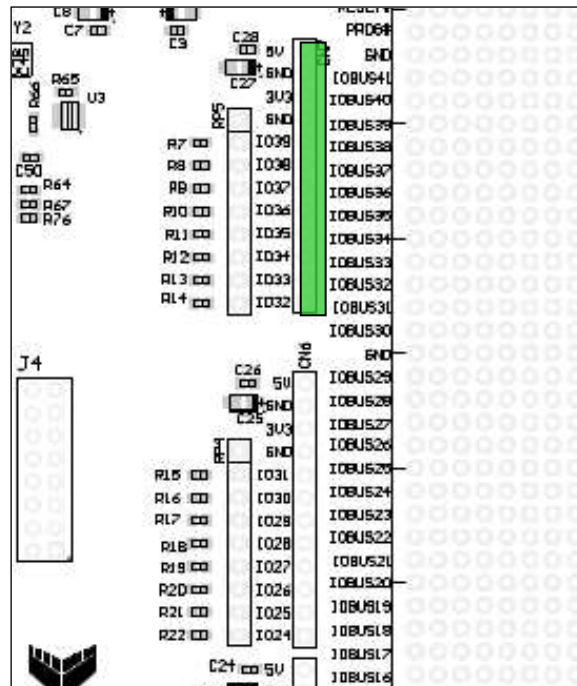

Figure 5.6 GPIO[32:39] Connector CN7

Signal name	Connector pin	VCN2 Pin No			IO type	Description
		32-PIN	48-PIN	64-PIN		
GPIO32 <sup>(16)</sup>	1	29	15	51	IO	GPIO port, data bit 32
GPIO33 <sup>(16)</sup>	2	30	16	52	IO	GPIO port, data bit 33
GPIO34 <sup>(16)</sup>	3	31	18	55	IO	GPIO port, data bit 34
GPIO35 <sup>(16)</sup>	4	32	19	56	IO	GPIO port, data bit 35
GPIO36 <sup>(16)</sup>	5	-	-	57	IO	GPIO port, data bit 36
GPIO37 <sup>(16)</sup>	6	-	-	58	IO	GPIO port, data bit 37
GPIO38 <sup>(16)</sup>	7	-	-	59	IO	GPIO port, data bit 38
GPIO39 <sup>(16)</sup>	8	-	-	60	IO	GPIO port, data bit 39
GND	9	-	-	-	-	Ground pin
3.3V <sup>(17)</sup>	10	-	-	-	-	3.3V power rail.
GND	11	-	-	-	-	Ground pin
5V <sup>(18)</sup>	12	-	-	-	-	5V power rail.

Notes:

- (16) All VNC2's IO pins can be driven from 3.3V LVTTTL logic levels. The use of these pins for GPIO is set by the IOMUX on the VNC2 device. The pins are shared by other connectors on the board. Care should be taken to ensure that pins are not driven from other headers on the board.
- (17) This pin is connected to 3.3V regulator output. External device can draw no more than 100mA when board is powered from an external power supply and no more than 50mA when the board is powered from USB bus.
- (18) This pin is connected to the board's 5V power rail. External device can draw no more than 250mA when board is powered from power supply and no more than 50mA when the board is powered from USB power bus.

Table 5.5 GPIO port connector CN7

### 5.2.6 GPIO [40:43] Connector CN8

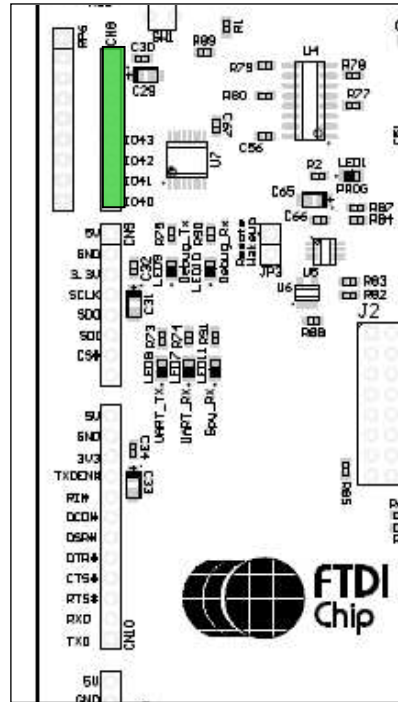

Figure 5.7 GPIO[32:39] Connector CN8

Signal name	Connector pin	VCN2 Pin No			IO type	Description
		32-PIN	48-PIN	64-PIN		
GPIO40 <sup>(19)</sup>	1	-	20	61	IO	GPIO port, data bit 40
GPIO41 <sup>(19)</sup>	2	-	21	62	IO	GPIO port, data bit 41
GPIO42 <sup>(19)</sup>	3	-	22	63	IO	GPIO port, data bit 42
GPIO43 <sup>(19)</sup>	4	-	23	64	IO	GPIO port, data bit 43
GND	5	-	-	-	-	Ground pin
3.3V <sup>(20)</sup>	6	-	-	-	-	3.3V power rail.
GND	7	-	-	-	-	Ground pin
5V <sup>(21)</sup>	8	-	-	-	-	5V power rail.

Notes:

- (19) All VNC2's IO pins can be driven from 3.3V LVTTTL TTL logic levels. The use of these pins for GPIO is set by the IOMUX on the VNC2 device. The pins are shared by other connectors on the board. Care should be taken to ensure that pins are not driven from other headers on the board.
- (20) This pin is connected to 3.3V regulator output. External device can draw no more than 100mA when board is powered from an external power supply and no more than 50mA when the board is powered from USB bus.
- (21) This pin is connected to the board's 5V power rail. External device can draw no more than 250mA when board is powered from an external power supply and no more than 50mA when the board is powered from USB bus.

Table 5.6 GPIO port connector CN8

### 5.3 SPI Connector C9

**Table 5.7** details connector pinout for the SPI connector C9. A full description of each signal is available in the [VNC2](#) data sheet.

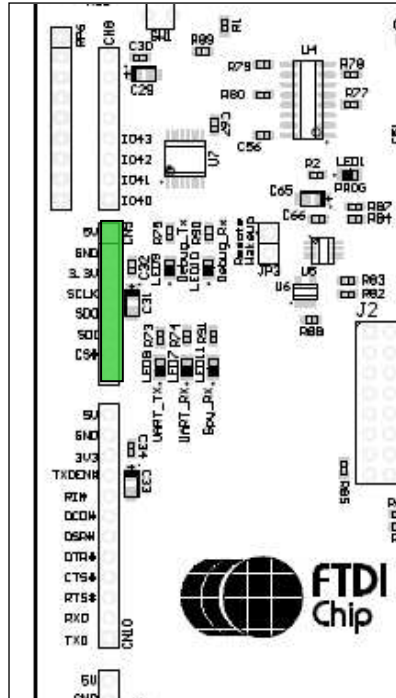

**Figure 5.8** SPI Connector CN9

Signal name	Connector pin	VCN2 Pin No		IO type	Description
		48-PIN	64-PIN		
5V <sup>(22)</sup>	1	-	-	-	5V power rail.
GND	2	-	-	-	Ground pin
3.3V <sup>(23)</sup>	3	-	-	-	3.3V power rail.
SCLK <sup>(24)</sup>	4	20	61	Input	SPI CLK Input
SDO <sup>(24)</sup>	5	21	62	Output	SPI Master out slave in
SDI <sup>(24)</sup>	6	22	63	Input	SDI Master in slave out
CS# <sup>(24)</sup>	7	23	64	Output	Active low slave chip select 0 from master to slave 0
GND	8	-	-	-	Ground pin

Notes:

- (22) This pin is connected to the board's 5V power rail. External device can draw no more than 250mA when board is powered from an external power supply and no more than 50mA when the board is powered from USB bus.
- (23) This pin is connected to 3.3V regulator output. External device can draw no more than 100mA when board is powered from an external power supply and no more than 50mA when the board is powered from USB bus.
- (24) All VNC2's IO pins can be driven from 3.3V LVTTTL TTL logic levels.. The use of these pins for GPIO is set by the IOMUX on the VNC2 device. The pins are shared by other connectors on the board. Care should be taken to ensure that pins are not driven from other headers on the board.

**Table 5.7** SPI Port Connector CN9

## 5.4 UART Interface Connector C10

**Table 5.8** details connector pinout for the UART connector C10. A full description of each signal is available in the [VNC2](#) data sheet.

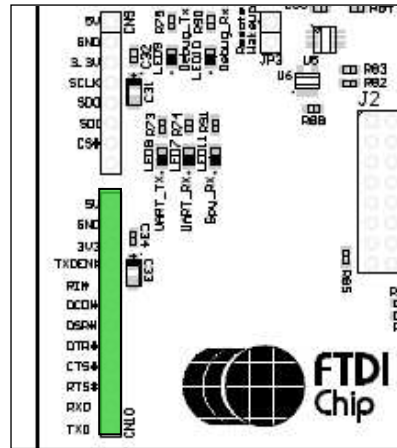

**Figure 5.9** UART Connector CN10

Signal name	Connector pin	VNC2 Pin No			IO type	Description
		32-PIN	48-PIN	64-PIN		
TXD <sup>(25)</sup>	1	23	31	39	Output	Transmit data
RXD <sup>(25)</sup>	2	24 <sup>(26)</sup>	32 <sup>(26)</sup>	40	Input	Receive data
RTS# <sup>(25)</sup>	3	25	33	41	Output	Request to Send Control Output / Handshake signal.
CTS# <sup>(25)</sup>	4	26 <sup>(26)</sup>	34 <sup>(26)</sup>	42	Input	Clear to Send Input / Handshake signal.
DTR# <sup>(25)</sup>	5		35	43	Output	Data Terminal Ready Output / Handshake signal.
DSR# <sup>(25)</sup>	6		36	44	Input	Data Set Ready Input / Handshake signal.
DCD# <sup>(25)</sup>	7		37	45	Input	Data Carrier Detect Control Input
RI# <sup>(25)</sup>	8		38	46	Input	Ring Indicator Control Input
TXDEN# <sup>(25)</sup>	9		-	47	Output	Transmit Data Enable
3.3V <sup>(27)</sup>	10		-	-	-	3.3V power rail.
GND	11		-	-	-	Ground pin
5V <sup>(28)</sup>	12		-	-	-	5V power rail.

**Notes:**

- (25) All VNC2's IO pins can be driven from 3.3V LVTTTL TTL logic levels.. The use of these pins for GPIO is set by the IOMUX on the VNC2 device. The pins are shared by other connectors on the board. Care should be taken to ensure that pins are not driven from other headers on the board.
- (26) The following pins are only accessible on VNC2 when the onboard multiplexer select input is high. See section 6.4 for details.
- (27) This pin is connected to 3.3V regulator output. External device can draw no more than 100mA when board is powered from power supply and no more than 50mA when the board is powered from USB power bus.
- (28) This pin is connected to the board's 5V power rail. External device can draw no more than 250mA when board is powered from power supply and no more than 50mA when the board is powered from USB power bus.

**Table 5.8** UART Interface Connector CN10

## 5.5 FIFO Interface Connector CN11

**Table 5.9** details connector pinout for the FIFO connector C11. A full description of each signal is available in the [VNC2](#) data sheet.

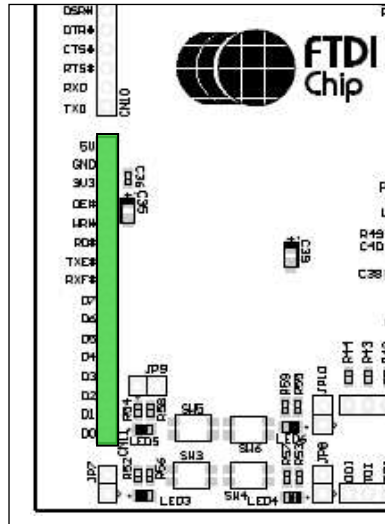

**Figure 5.10** FIFO Connector CN11

Signal name	Connector pin	VNC2 Pin No			IO type	Description
		32-PIN	48-PIN	64-PIN		
D0 <sup>(29)</sup>	1	-	-	15	IO	FIFO data bit 0, bidirectional
D1 <sup>(29)</sup>	2	-	-	16	IO	FIFO data bit 1, bidirectional
D2 <sup>(29)</sup>	3	-	-	17	IO	FIFO data bit 2, bidirectional
D3 <sup>(29)</sup>	4	-	-	18	IO	FIFO data bit 3, bidirectional
D4 <sup>(29)</sup>	5	-	-	19	IO	FIFO data bit 4, bidirectional
D5 <sup>(29)</sup>	6	-	-	20	IO	FIFO data bit 5, bidirectional
D6 <sup>(29)</sup>	7	-	-	22	IO	FIFO data bit 6, bidirectional
D7 <sup>(29)</sup>	8	-	-	23	IO	FIFO data bit 7, bidirectional
RXF#	9	-	-	24	Output	FIFO receive full output
TXE#	10	-	-	25	Output	FIFO transmitter buffer empty output
RD#	11	-	-	26	Input	FIFO read enable input
WR#	12	-	-	27	Input	FIFO write enable input
OE#	13	-	-	28	Input	FIFO output enable – synchronous FIFO only
3.3V <sup>(30)</sup>	14	-	-	-	-	3.3V power rail.
GND	15	-	-	-	-	Ground pin
5V <sup>(31)</sup>	16	-	-	-	-	5V power rail.

**Notes:**

- (29) All VNC2's IO pins can be driven from 3.3V LVTTTL TTL logic levels. The use of these pins for GPIO is set by the IOMUX on the VNC2 device. The pins are shared by other connectors on the board. Care should be taken to ensure that pins are not driven from other headers on the board.
- (30) This pin is connected to 3.3V regulator output. External device can draw no more than 100mA when board is powered from an external power supply and no more than 50mA when the board is powered from USB bus.
- (31) This pin is connected to the board's 5V power rail. External device can draw no more than 250mA when board is powered from an external power supply and no more than 50mA when the board is powered from USB bus.

**Table 5.9** FIFO Interface Connector CN11

## 5.6 Prototyping area

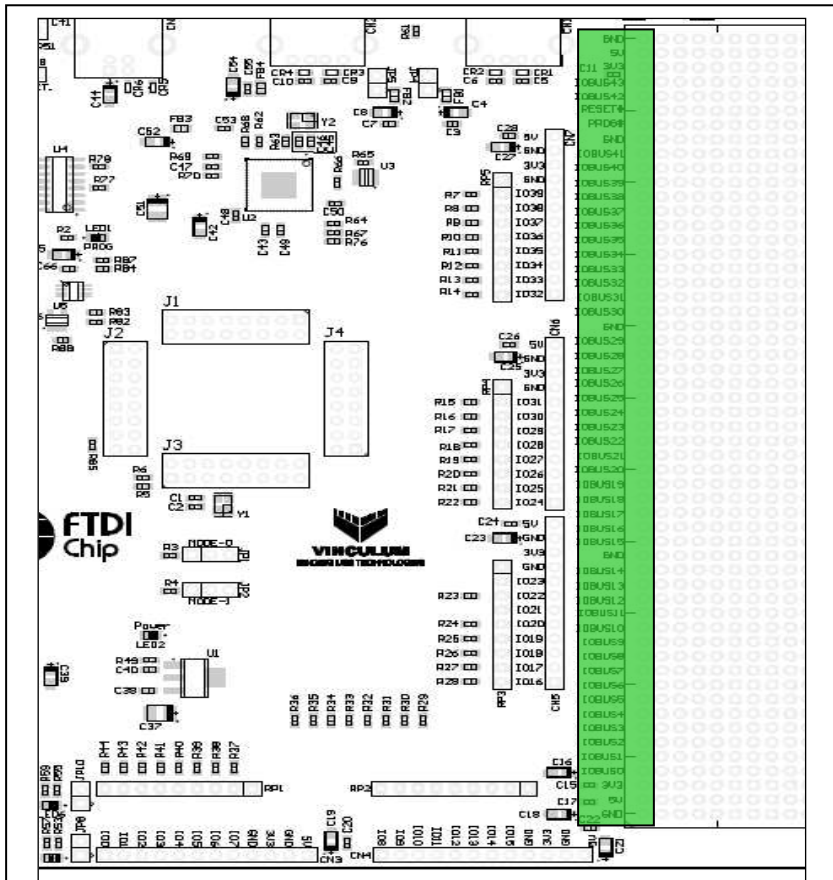

**Figure 5.11 Prototyping area P1**

A prototype area consisting of an array of 1100, 0.1-inch pitch holes is provided. The area can be used to create custom circuitry and connect components to the V2-EVAL board. The prototyping area includes connections to the 5V, 3.3 V planes and ground planes. The silk-screen text on the board indicates which holes are connected to which signals. Only the first column is connected to VNC2 IO ports, power and ground planes. All the other holes are not connected to anything on the board.

Signal pins are shared between other IO connectors on the board. For more information refer to the V2-Eval Board schematics.



Connector pin number	Silk Screen Signal Label	VCN2 Pin No			IO type	Description
		32-PIN	48-PIN	64-PIN		
1	GND	-	-	-	-	Ground pin
2	5V <sup>(32)</sup>	-	-	-	-	5V power rail. Can be used to power external devices
3	3.3V <sup>(33)</sup>	-	-	-	-	3.3V power rail. Can be used to power external devices
4	IOBUS0 <sup>(34)</sup>	11	11	11	IO	IOBUS port Data Bit 0. Debug port – default configuration.
5	IOBUS1 <sup>(34)</sup>	12	12	12	IO	IOBUS port Data Bit 1.
6	IOBUS2 <sup>(34)</sup>	14	13	13	IO	IOBUS port Data Bit 2.
7	IOBUS3 <sup>(34)</sup>	15	14	14	IO	IOBUS port Data Bit 3.
8	IOBUS4 <sup>(34)</sup>	-	-	15	IO	IOBUS port Data Bit 4.
9	IOBUS5 <sup>(34)</sup>	-	-	16	IO	IOBUS port Data Bit 5.
10	IOBUS6 <sup>(34)</sup>	-	-	17	IO	IOBUS port Data Bit 6.
11	IOBUS7 <sup>(34)</sup>	-	-	18	IO	IOBUS port Data Bit 7.
12	IOBUS8 <sup>(34)</sup>	-	-	19	IO	IOBUS port Data Bit 8.
13	IOBUS9 <sup>(34)</sup>	-	-	20	IO	IOBUS port Data Bit 9.
14	IOBUS10 <sup>(34)</sup>	-	-	22	IO	IOBUS port Data Bit 10.
15	IOBUS11 <sup>(34)</sup>	-	-	23	IO	IOBUS port Data Bit 11.
16	IOBUS12 <sup>(34)</sup>	-	-	24	IO	IOBUS port Data Bit 12.
17	IOBUS13 <sup>(34)</sup>	-	-	25	IO	IOBUS port Data Bit 13.
18	IOBUS14 <sup>(34)</sup>	-	-	26	IO	IOBUS port Data Bit 14.
19	GND	-	-	-	-	Ground pin
20	IOBUS15 <sup>(34)</sup>	-	-	27	IO	IOBUS port Data Bit 15.
21	IOBUS16 <sup>(34)</sup>	-	-	27	IO	IOBUS port Data Bit 16.
22	IOBUS17 <sup>(34)</sup>	-	46	28	IO	IOBUS port Data Bit 17.
23	IOBUS18 <sup>(34)</sup>	-	45	29	IO	IOBUS port Data Bit 18.
24	IOBUS19 <sup>(34)</sup>	-	48	31	IO	IOBUS port Data Bit 19.
25	IOBUS20 <sup>(34)</sup>	23	31	32	IO	IOBUS port Data Bit 20.
26	IOBUS21 <sup>(34)</sup>	24 <sup>(35)</sup>	32 <sup>(35)</sup>	39	IO	IOBUS port Data Bit 21.
27	IOBUS22 <sup>(34)</sup>	25	33	40	IO	IOBUS port Data Bit 22.
28	IOBUS23 <sup>(34)</sup>	26 <sup>(35)</sup>	34 <sup>(35)</sup>	41	IO	IOBUS port Data Bit 23.
29	IOBUS24 <sup>(34)</sup>	-	35	43	IO	IOBUS port Data Bit 24.
30	IOBUS25 <sup>(34)</sup>	-	36	44	IO	IOBUS port Data Bit 25.
31	IOBUS26 <sup>(34)</sup>	-	37	45	IO	IOBUS port Data Bit 26.
32	IOBUS27 <sup>(34)</sup>	-	38	46	IO	IOBUS port Data Bit 27.
33	IOBUS28 <sup>(34)</sup>	-	41	47	IO	IOBUS port Data Bit 28.
34	IOBUS29 <sup>(34)</sup>	-	42	48	IO	IOBUS port Data Bit 29.
35	GND	-	-	-	-	
36	IOBUS30 <sup>(34)</sup>	-	43	49	IO	IOBUS port Data Bit 30.
37	IOBUS31 <sup>(34)</sup>	-	44	50	IO	IOBUS port Data Bit 31.
38	IOBUS32 <sup>(34)</sup>	29	15	51	IO	IOBUS port Data Bit 32.
39	IOBUS33 <sup>(34)</sup>	30	16	52	IO	IOBUS port Data Bit 33.
40	IOBUS34 <sup>(34)</sup>	31	18	55	IO	IOBUS port Data Bit 34.
41	IOBUS35 <sup>(34)</sup>	32	19	56	IO	IOBUS port Data Bit 35.

42	IOBUS36 <sup>(34)</sup>	-	-	57	IO	IOBUS port Data Bit 36.
43	IOBUS37 <sup>(34)</sup>	-	-	58	IO	IOBUS port Data Bit 37.
44	IOBUS38 <sup>(34)</sup>	-	-	59	IO	IOBUS port Data Bit 38.
45	IOBUS39 <sup>(34)</sup>	-	-	60	IO	IOBUS port Data Bit 39.
46	IOBUS40 <sup>(34)</sup>	-	20	61	IO	IOBUS port Data Bit 40.
47	IOBUS41 <sup>(34)</sup>	-	21	62	IO	IOBUS port Data Bit 41.
48	GND	-	-	-	-	Ground pin
49	PROG#	9	10	10	I	VNC2 PROG# pin
50	RESET#	10	9	9	I	VNC2 RESET# pin
51	IOBUS42 <sup>(35)</sup>	-	22	63	-	IOBUS port Data Bit 42.
52	IOBUS43 <sup>(35)</sup>	-	23	64	-	IOBUS port Data Bit 43.
53	3.3V <sup>(33)</sup>	-	-	-	-	3.3V power rail. Can be used to power external devices
54	5V <sup>(32)</sup>	-	-	-	-	5V power rail. Can be used to power external devices
55	GND	-	-	-	-	Ground pin

Notes:

- (32) This pin is connected to the board's 5V power rail. External device can draw no more than 250mA when board is powered from power supply and no more than 50mA when the board is powered from USB power bus.
- (33) This pin is connected to 3.3V regulator output.
- (34) The IOBUS signal labels on the PCB silk screen do directly relate to the IOBUS signal names for the VNC2 device on the daughterboard. See VNC2 pin number for signal mapping on the device.
- (35) The following pins are only accessible when the onboard multiplexer select input is high. See section 6.4 for details.

**Table 5.10 Prototyping Area Pinout**

## 5.7 USB1 interface CN1

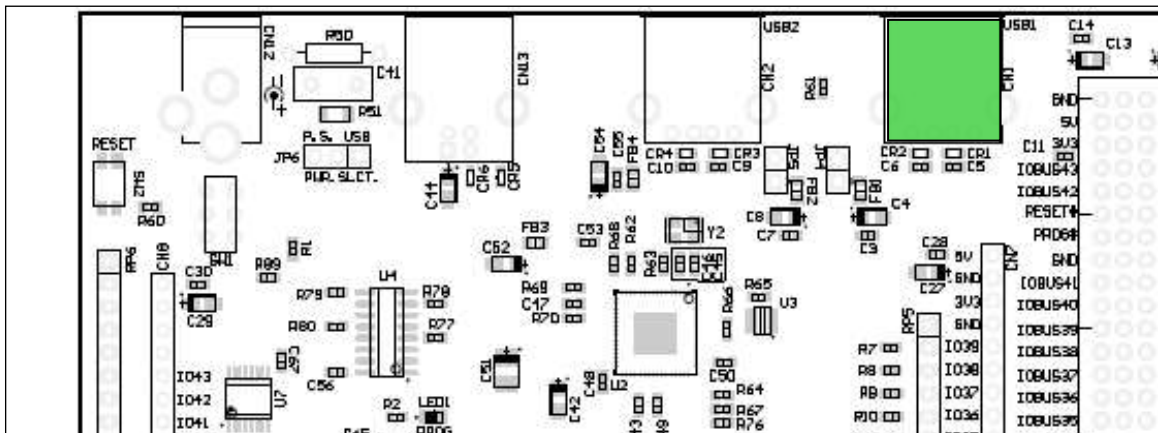

Figure 5.12 USB1 Interface CN1

VNC2 USB1 transceiver pins are brought on this connector. Depending on the firmware version this port can be configured as host or slave port.

Signal name	Connector pin number	VCN2 pin name	VCN2 pin number			IO type	Description
			32-PIN	48-PIN	64-PIN		
5V <sup>(36)</sup>	1	-	-			-	5V power rail. Can be used to power external devices
USB1-DM	2	USB1 DM	17	25	33	IO	USB1 transceiver, data line Minus
USB1-DP	3	USB1 DP	18	26	34	IO	USB1 transceiver, data line Plus
GND	4	-	-			-	Ground pin
Shield	5, 6	-	-			-	Connector shield. Connected to ground.
Notes:							
(36) This pin is connected to the board's 5V power rail. External device can draw no more than 250mA when board is powered from power supply and no more than 50mA when the board is powered from USB power bus.							

Table 5.11 USB1 Host/Slave Connector CN1

## 5.8 USB2 interface CN2.

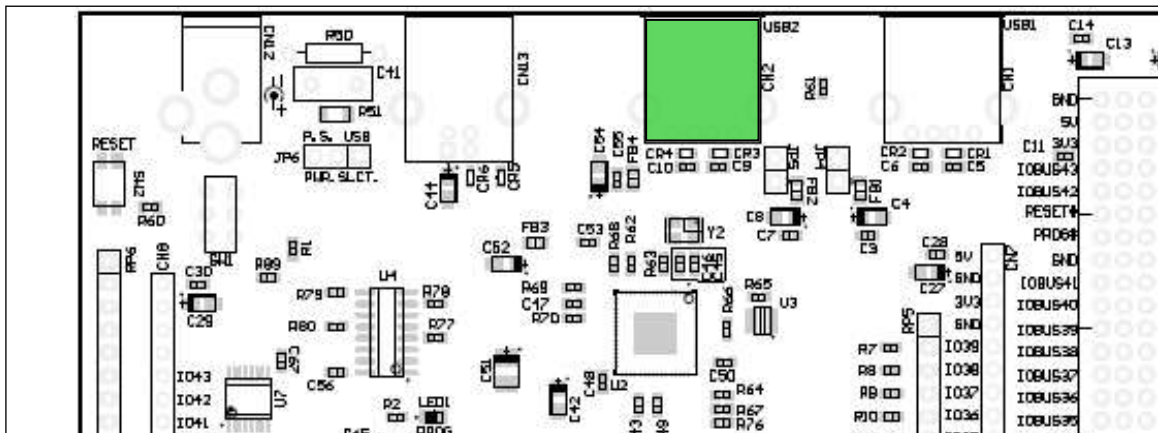

Figure 5.13 USB2 Interface CN2

VNC2 USB2 transceiver pins are brought on this connector. Depending on the version of the firmware running on the device, the port can be configured as host or slave port.

Signal name	Connector pin number	VCN2 pin name	VCN2 pin number			IO type	Description
			32-PIN	48-PIN	64-PIN		
5V <sup>(37)</sup>	1	-	-			-	5V power rail. Can be used to power external devices
USB2-DM	2	USB2 DM	20	28	36	IO	USB2 transceiver, data line Minus
USB2-DP	3	USB2 DP	21	29	37	IO	USB2 transceiver, data line Plus
GND	4	-	-			-	Ground pin
Shield	5, 6	-	-			-	Connector shield. Connected to ground.
Notes:							
(37) This pin is connected to the board's 5V power rail. External device can draw no more than 250mA when board is powered from power supply and no more than 50mA when the board is powered from USB power bus.							

Table 5.12 USB2 Host / Slave connector CN2

## 5.9 VNC1L Interface Mode Select / GPIO Jumpers JP1, JP2

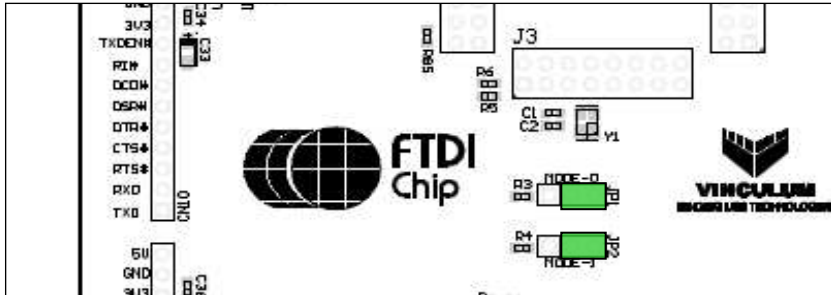

Figure 5.14 GPIO Jumper pins, JP1, JP2

JP1 and JP2 jumpers are designed to provide backwards compatibility for VNC1L firmwares migrated to the VNC2. The jumpers are used select between the UART, FIFO and SPI slave interface for use as the monitor port on the VNC1L. The jumper configurations for each interface are listed in Table 5.14. More details on the monitor port are available in the VNC1L Firmware User Manual (FT\_000006).

When not running VNC1L firmwares, jumpers JP1 and JP2 can be used by designers as general purpose GPIO jumper select inputs to the VNC2.

Jumper	VNC2 Pin Number / Signal Name		VNC2 Signal Name Comments
	48-PIN	64-PIN	
JP1	46 / IOBUS25 <sup>(38)</sup>	29 / IOBUS17	INT_SEL0. Signal also connected to LED5
JP2	47 / IOBUS26	-	INT_SEL1.

Notes:

- (38) To run VNC1L firmwares, jumper JP9 must also be removed.
- (39) The use of these pins for GPIO is set by the IOMUX on the VNC2 device. The pins are shared by other connectors on the board. Care should be taken to ensure that pins are not driven from other headers on the board.

Table 5.13 GPIO jumpers JP1, JP2

JP1 (INT_SEL0)	JP2 (INT_SEL1)	Mode
Pull-up	Pull-up	Serial UART
Pull-down	Pull-up	SPI
Pull-up	Pull-down	FIFO
Pull-down	Pull-down	Serial UART

Table 5.14 Monitor Interface Select – VNC1L Firmware Backwards Compatibility

### 5.10 User LEDs. LED3 – LED6.

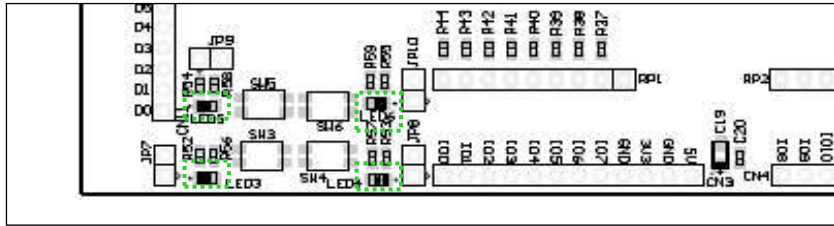

Figure 5.15 User LEDs

Four LEDs is provided on board. The LEDs enabled or disabled via jumpers JP7 – JP10. The LEDs are controlled by the IOBUS signals on the VNC2.

Note - LED5 is also connected to jumper JP1 on the board. Care should be taken to ensure that LED is not being driven by JP1 when controlling the LED from the VNC2.

Designator	VCN2 pin number		
	32-PIN	48-PIN	64-PIN
LED3	12	12	12
LED4	14	13	13
LED5 <sup>(40)</sup>	-	46	29
LED6	-	45	31

Notes:  
(40) LED5 is also connected to jumper JP1 on the board. Care should be taken to ensure that LED is not being driven by JP1 when controlling the LED from the VNC2. Further, when running VNC1L migrated firmwares, LED5 is not available on 48-pin package as the I/O signal is used for interface selection purposes by the firmware.

Table 5.15 User LED connections

### 5.11 LED enable/disable jumpers JP10 – JP14.

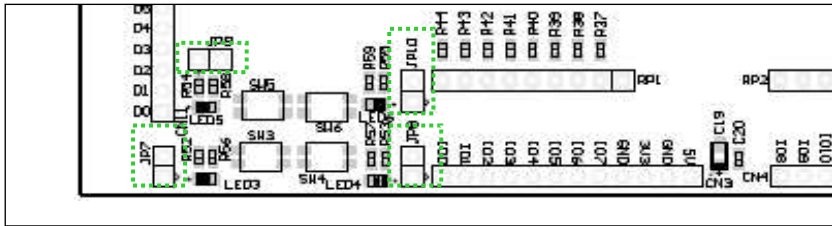

**Figure 5.16 LED Enable/Disable jumpers**

Every user-defined LED have an enable/disable jumper. When jumper is closed LED will be illuminate when driven low by one of the VNC2 pins. When jumper is opened LED is disconnected from the VCN2 pin.

Designator	LED affected
JP7	LED3
JP8	LED4
JP9 <sup>(41)</sup>	LED5
JP10	LED6
Notes:	
(41) When running VNC1L migrated firmwares on 48-pin package, the jumper JP9 must be removed, thus disabling this LED.	

**Table 5.16 LED Enable/Disable Jumpers.**

### 5.12 User push button switches

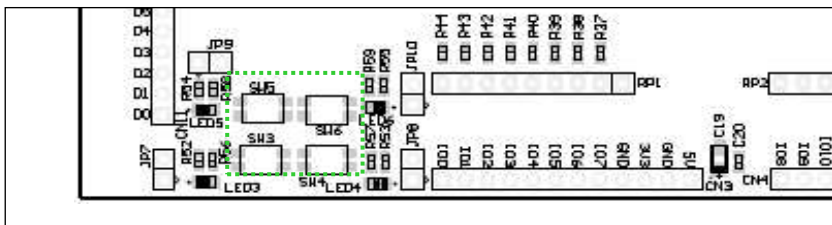

**Figure 5.17 User Push Button Switches**

Push button switches connected straight to VNC2 pins. When the switch is pressed down, a logic LOW appears on the corresponding VNC2 pin.

Designator	VNC2 Pin Number		
	32-PIN	48-PIN	64-PIN
SW3 <sup>(42)</sup>	15	14	14
SW4 <sup>(42)</sup>	-	48	32
SW5 <sup>(42)</sup>	-	42	48
SW6 <sup>(42)</sup>	-	43	49
Notes:			
(42) The IOBUS pins are shared by other connectors on the board. Care should be taken to ensure that operation of the switches does not interfere with pins used by other headers on the board.			

**Table 5.17 User Switches**

### 5.13 Host USB power jumpers JP4, JP5.

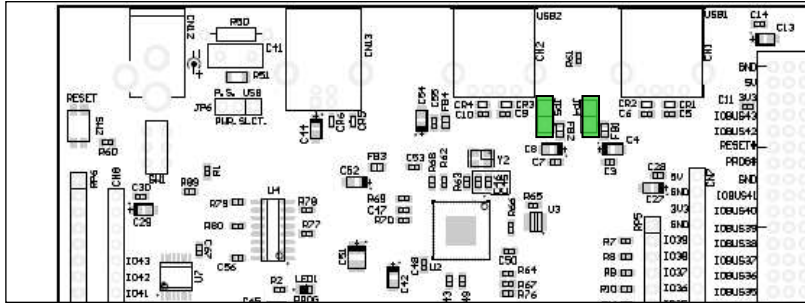

**Figure 5.18 USB Power Enable Jumpers JP4 and JP5**

When either USB1 and/or USB2 ports are used as a host ports, the jumpers JP4 and/or JP5 accordingly should be closed to allow peripheral devices to draw power from board's +5V power rail.

**Warning!**

**When using USB1 and USB2 ports as a USB slave ports, remove the shunts from jumpers JP4 and JP5. Failure to do so could cause damage to the USB host or to the V2-EVAL board.**



### 5.14 Remote Wakeup jumper JP3.

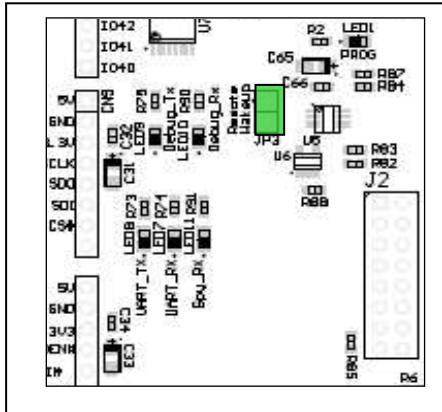

**Figure 5.19 Remote Wakeup Jumper**

The remote wakeup jumper enables any firmware running on the VNC2 to support Suspend Monitor (SUM) mode, allowing the device to reduce power consumption when idle. The VNC2 device can be configured to wakeup when any data arrives on the receive data (RXD) pin, by connecting the RXD pin to ring indicator (RI#) input via jumper JP3. When RI# pin is driven low, VNC2 will resume from the SUM mode immediately. The remote wakeup feature is only available when using the UART interface on the VNC2. The feature can be enabled when a jumper is present on jumper JP3.

## 5.15 Reset Push-button Switch

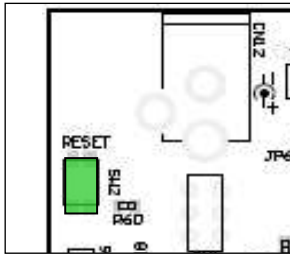

Figure 5.20 Reset Switch

A 'RESET' push button switch is provided on switch SW2, to enable manual resetting of the VNC2 device.

## 5.16 'PROG' LED

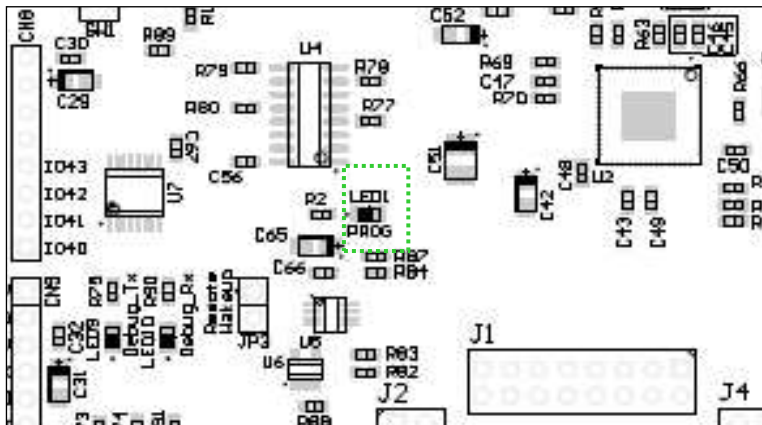

Figure 5.21 'PROG' LED

LED1 (red) is provided to indicate when VNC2 device is in Flash programming mode.

## 5.17 VNC2 Daughterboard Connector – J1

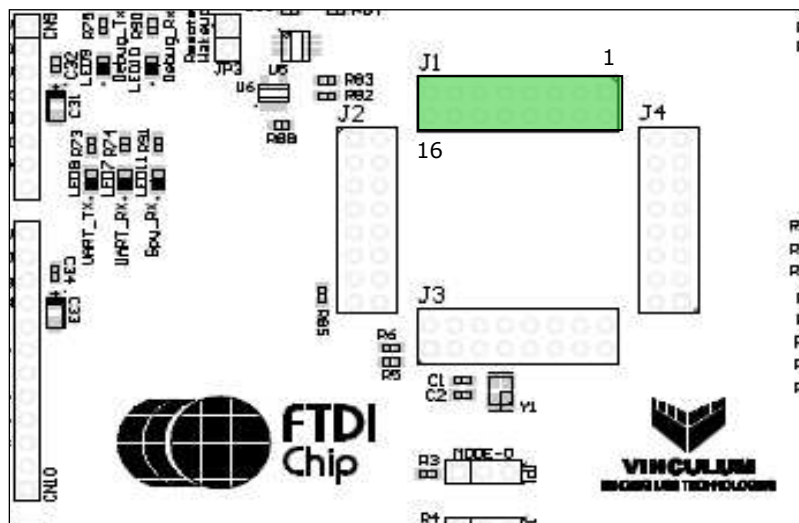

Figure 5.22 VNC2 Daughterboard Connector J1

Schematic Signal Name <sup>(43)</sup>	Connector Pin	VNC2 Pin No			IO type	Description
		32-PIN	48-PIN	64-PIN		
3.3V	1	-	-	-	-	3.3V power rail.
3.3V	2	-	-	-	-	3.3V power rail.
GND	3	-	-	-	-	Ground pin.
USB1DP	4	17	25	33	IO	USB1 transceiver, data line positive connected to CN1.
USB1DM	5	18	26	34	IO	USB1 transceiver, data line minus connected to CN1.
SPI_S0_CLK	6	29	15	51	IO	Connected to P1 pin 38 / CN7 pin 1.
SPI_S0_MOSI	7	30	16	52	IO	Connected to P1 pin 39 / CN7 pin 2.
SPI_S0_MISO	8	31	18	55	IO	Connected to P1 pin 40 / CN7 pin 3.
SPI_S0_CS#	9	32	19	56	IO	Connected to P1 pin 40 / CN7 pin 4.
USB2DP	10	20	28	36	IO	USB2 transceiver, data line positive connected to CN2.
USB2DM	11	21	29	37	IO	USB2 transceiver, data line minus connected to CN2.
V_TXD	12	23	31	39	IO	Connected to P1 pin 25 / CN10 pin 1 / CN5 pin 5.
V_RXD	13	24	32	40	IO	Connected to P1 pin 26 / CN10 pin 2 / CN5 pin 6.
V_RTS#	14	25	33	41	IO	Connected to P1 pin 27 / CN10 pin 3 / CN5 pin 7.
V_CTS#	15	26	34	42	IO	Connected to P1 pin 28 / CN10 pin 4 / CN5 pin 8.
V_DTR#	16	-	35	43	IO	Connected to P1 pin 29 / CN10 pin 5 / CN6 pin 1.
Notes:						
(43) The signal names relate to the labels used on pages 1 & 2 of the V2-EVAL base board schematic. Unless otherwise stated, the function of the IO signals is be set by the user application running on the VNC2.						

Table 5.18 Connector J1 Pinout

## 5.18 VNC2 Daughterboard Connector – J2

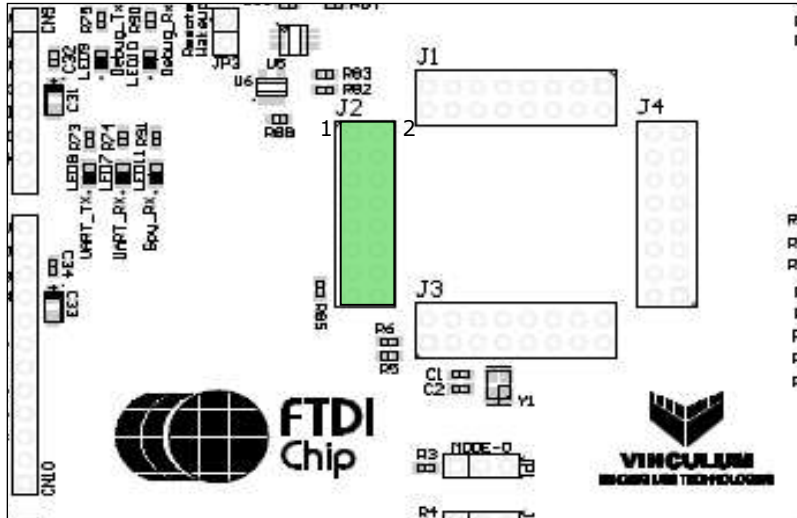

Figure 5.23 VNC2 Daughterboard Connector J2

Schematic Signal Name <sup>(44)</sup>	Connector Pin	VCN2 Pin No			IO type	Description
		32-PIN	48-PIN	64-PIN		
V_DSR#	1	-	36	44	IO	Connected to P1 pin 30 / CN10 pin 6 / CN6 pin 2.
V_DCD#	2	-	37	45	IO	Connected to P1 pin 31 / CN10 pin 7 / CN6 pin 3.
V_RI#	3	-	38	46	IO	Connected to P1 pin 32 / CN10 pin 8 / CN6 pin 4.
V_TXDEN	4	-	41	47	IO	Connected to P1 pin 33 / CN10 pin 9 / CN6 pin 5.
3.3V	5	-	-	-	-	3.3V power rail.
3.3V	6	-	-	-	-	3.3V power rail.
GPIO7	7	-	42	48	IO	Connected to P1 pin 34 / CN6 pin 6.
GPIO8	8	-	43	49	IO	Connected to P1 pin 36 / CN6 pin 7.
GPIO9	9	-	44	50	IO	Connected to P1 pin 37 / CN6 pin 8.
SPI_S1_CLK	10	-	-	57	IO	Connected to P1 pin 42 / CN7 pin 5.
SPI_S1_MOSI	11	-	-	58	IO	Connected to P1 pin 43 / CN7 pin 6.
SPI_S1_MISO	12	-	-	59	IO	Connected to P1 pin 44 / CN7 pin 7.
GND	13	-	-	-	-	Ground pin.
SPI_S1_CS#	14	-	-	60	IO	Connected to P1 pin 45 / CN7 pin 8.
DEBUG_IF	15	11	11	11	IO	Debug pin. Connected to P1 pin 4 / CN3 pin 1.
GND	16	-	-	-	-	Ground pin.

Notes:  
(44) The signal names relate to the labels used on pages 1 & 2 of the V2-EVAL base board schematic. Unless otherwise stated, the function of the IO signals is set by the user application running on the VNC2.

Table 5.19 Connector J2 Pinout

## 5.19 VNC2 Daughterboard Connector – J3

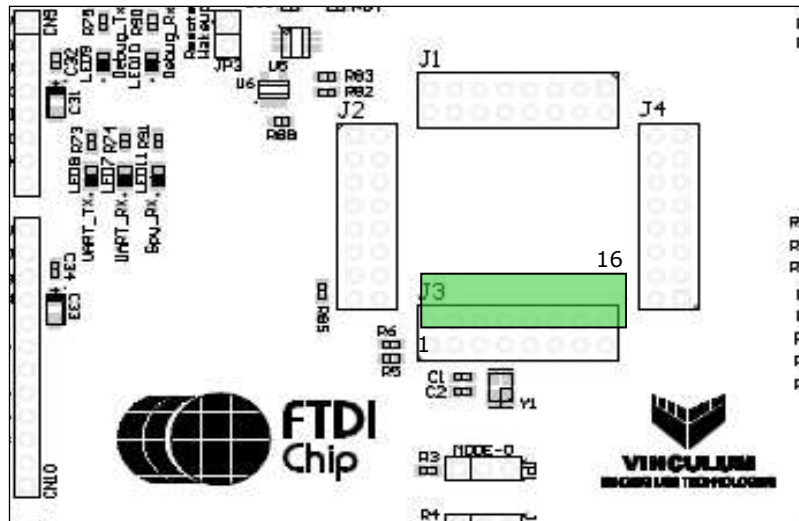

Figure 5.24 VNC2 Daughterboard Connector J3

Schematic Signal Name <sup>(45)</sup>	Connector Pin	VCN2 Pin No			IO type	Description
		32-PIN	48-PIN	64-PIN		
PROG#	1	9	10	10	Input	PROG# input to VNC2. Connected via multiplexer U4.
RESET#	2	10	9	9	Input	RESET# input to VNC2. Connected via multiplexer U4.
SPI_M_CS#	3	-	23	64	IO	Connected to P1 pin 52 / CN9 pin 7/ CN8 pin 4.
SPI_M_MISO	4	-	22	63	IO	Connected to P1 pin 51 / CN9 pin 6/ CN8 pin 3.
SPI_M_MOSI	5	-	21	62	IO	Connected to P1 pin 47 / CN9 pin 5/ CN8 pin 2.
SPI_M_CLK	6	-	20	61	IO	Connected to P1 pin 46 / CN9 pin 4/ CN8 pin 1.
XTOUT	7	5	5	5	Output	Output from 12MHz oscillator cell on VNC2.
XTIN	8	4	4	4	Input	Input to 12MHz oscillator cell on VNC2.
GPIO2	9	14	13	13	IO	Connected to P1 pin 6 / CN3 pin 3.
GPIO1	10	12	12	12	IO	Connected to P1 pin 5 / CN3 pin 2.
FIFO_DATA0	11	-	-	15	IO	Connected to P1 pin 8/CN3 pin 5 /CN11 pin 1.
GPIO3	12	15	14	14	IO	Connected to P1 pin 7 / CN3 pin 4.
FIFO_DATA2	13	-	-	17	IO	Connected to P1 pin 10/CN3 pin 7 /CN11 pin 3.
FIFO_DATA1	14	-	-	16	IO	Connected to P1 pin 9/CN3 pin 6 /CN11 pin 2.
GND	15	-	-	-	-	Ground pin.
GND	16	-	-	-	-	Ground pin.

Notes:

(45) The signal names relate to the labels used on pages 1 & 2 of the V2-EVAL base board schematic. Unless otherwise stated, the function of the IO signals is set by the user application running on the VNC2.

Table 5.20 Connector J3 Pinout

## 5.20 VNC2 Daughterboard Connector – J4

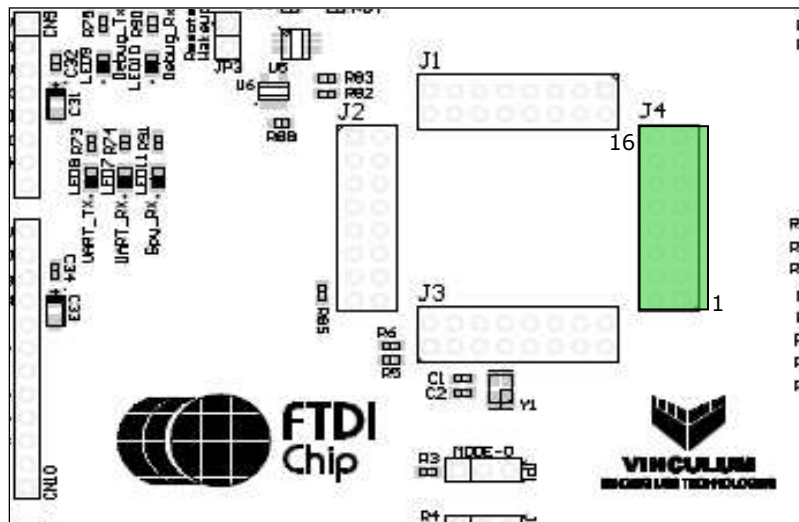

Figure 5.25 VNC2 Daughterboard Connector J4

Schematic Signal Name <sup>(46)</sup>	Connector Pin	VCN2 Pin No			IO type	Description
		32-PIN	48-PIN	64-PIN		
FIFO_DATA4	1	-	-	19	IO	Connected to P1 pin 12 / CN4 pin 1/ CN11 pin 5.
FIFO_DATA3	2	-	-	18	IO	Connected to P1 pin 11 / CN3 pin 8/ CN11 pin 4.
FIFO_DATA6	3	-	-	22	IO	Connected to P1 pin 14 / CN4 pin 3/ CN11 pin 7.
FIFO_DATA5	4	-	-	20	IO	Connected to P1 pin 13 / CN4 pin 2/ CN11 pin 6.
FIFO_RXF#	5	-	-	24	IO	Connected to P1 pin 16 / CN4 pin 5/ CN11 pin 9.
FIFO_DATA7	6	-	-	23	IO	Connected to P1 pin 15 / CN4 pin 4/ CN11 pin 8.
FIFO_RD#	7	-	-	26	IO	Connected to P1 pin 18 / CN4 pin 7/ CN11 pin 11.
FIFO_TXE#	8	-	-	25	IO	Connected to P1 pin 17 / CN4 pin 6/ CN11 pin 10.
FIFO_OE#	9	-	-	28	IO	Connected to P1 pin 21 / CN5 pin 1 / CN11 pin 13.
FIFO_WR#	10	-	-	27	IO	Connected to P1 pin 20 /CN4 pin 8 / CN11 pin 12.
GPIO5	11	-	45	31	IO	Connected to P1 pin 23 / CN5 pin 3.
INT_SEL0	12	-	46	29	IO	Connected to P1 pin 22 / CN5 pin 2.
INT_SEL1	13	-	47	-	IO	Connected to jumper JP2.
GPIO6	14	-	48	32	IO	Connected to P1 pin 24 / CN5 pin 4.
GND	15	-	-	-	-	-
GND	16	-	-	-	-	-

Notes:  
(46) The signal names relate to the labels used on pages 1 & 2 of the V2-EVAL base board schematic. Unless otherwise stated, the function of the IO signals is set by the user application running on the VNC2.

Table 5.21 Connector J4 Pinout

## 6 FT4232H Configuration

The V2-EVAL board features a FT4232H, a high speed USB to quad channel UART / serial converter device. The device is primarily featured to provide a connection from the board to a PC host via the onboard USB type B connector. Each of the four channels on the FT4232H device are used to provide a separate functions on the V2-EVAL board.

The functions of the FT4232H include:

- Channel A – UART interface. The FT4232H provides USB to UART conversion to allow a PC / USB host PC to communicate with the VNC2, via the UART interface.
- Channel B – Debug interface control. Enable software tool chain connectivity to the VNC2 debug interface via the the USB type B connector on the board.
- Channel C - Provide a UART data 'sniffer' interface allowing inputs to the VNC2 UART interface to be displayed on the host PC software.
- Channel D – Device control. I/O pins are used to control the onboard multiplexer. The multiplexer allows different interfaces to drive the VNC2 UART interface as well as the VNC2 PROG# and RESET# pins.

Figure 6.1, outlines the configuration circuit for FT4232H I/O ports.

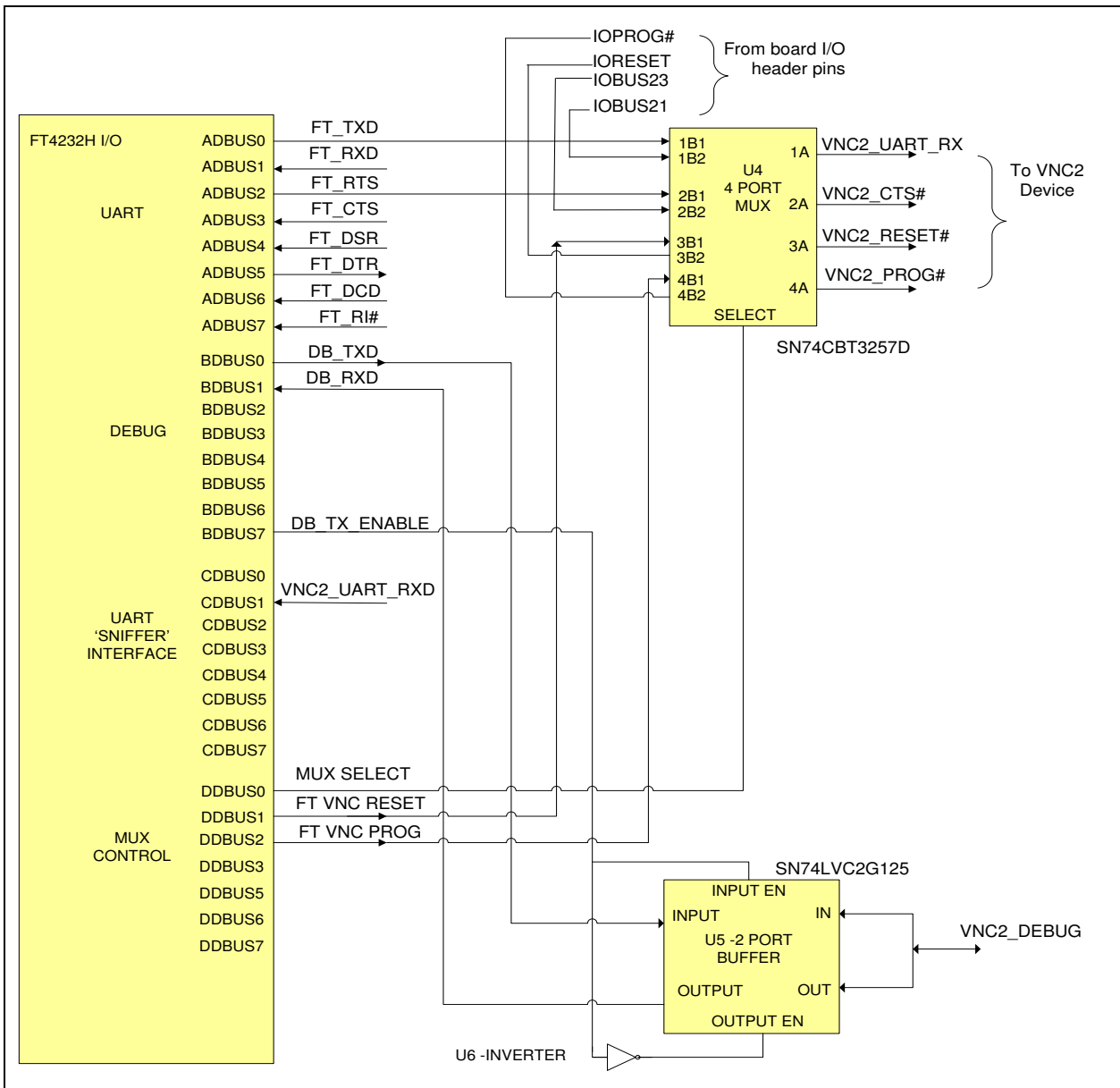

Figure 6.1: FT4232H Configuration

## 6.1 UART Interface

The FT4232H channel A, ADBUS I/O, pins are used for UART operation with the VNC2. The UART inputs to the FT4232H are supplied directly from the VNC2 device pins, while the UART outputs from the FT4232H, are passed to an external multiplexer. The multiplexer allows the UART interface to the VNC2 to be driven by either by the FT4232H device or by an external UART device, which is connected to the V2-EVAL board via the various board I/O header pins. The multiplexer select pin is controlled by pin DDBUS0 on the FT4232H, where a logic '0' on the select pin will force the FT4232H device to drive the UART interface on the VNC2, while a logic '1' will allow IOBUS21 and IOBUS23 header pins on the board to drive the UART.



## 6.2 Debug Interface – UART Mode

The FT4232H channel B I/O pins are used to control the debug interface on the VNC2 device. The channel is used to allow the device debug pin to be connected to a software debugger environment running on a PC. The single bit, bi-directional debug signal from VNC2 is converted into a UART style interface, with separate transmit and receive signals via a 2-port buffer. The signal on the BDBUS0 pin corresponds to the transmit data from the debug software, while BDBUS1 corresponds to the receive output from the VNC2. Pin BDBUS7, DB\_TX\_ENABLE, on the FT4232H is used for controlling transmit and receive operation on the 2 port buffer. When signal DB\_TX\_ENABLE is '1' then the signal VNC2\_DEBUG will drive the DB\_RXD input to the FT4232H. Alternatively when DB\_TX\_ENABLE is '0' then the FT4232H UART output DB\_TXD will drive the VNC2\_DEBUG signal.

## 6.3 UART 'Spy' Interface

Channel C on the FT4232H device is configured as a UART interface. The channel is used as a 'data spy' to detect any data sent to the VNC2 UART interface. The detected data is passed to software running on the PC for display. The feature is used for detecting and displaying UART data from external sources which are connected to the VNC2 UART interface, via the board I/O headers.

## 6.4 Device Control – Bit Bang Mode

The I/O signals on FT4232H channel D are used for additional control functions on the board. Pin DDBUS0 is used to control the channel select input on the multiplexer. A logic '0' on the multiplexer select pin will force multiplexer input B1 to drive the multiplexer output A, while a logic '1' will force multiplexer input B2 to drive the multiplexer output.

Pins DDBUS1 and DDBUS2 are used for controlling the PROG# and RESET# inputs on the VNC2 from the software via the FT4232H. Both pins are passed to the onboard multiplexer. A logic '0' on the multiplexer select input will allow the VNC2 PROG# and RESET# pins to be controlled by the FT4232H.

Table 6.1, summarises the V2-EVAL board settings based on the value of the multiplexer select pin.

Multiplexer Select Pin Status (Set by FT4232H DDBUS0)	Board Configuration Status
0	VNC2 UART interface connected to FT4232H channel A. VNC2 RESET# connected to FT4232H DDBUS1 output. VNC2 PROG# connected to FT4232H DDBUS2 output.
1	VNC2 UART interface connected to header pins on V2-EVAL board. VNC2 RESET# connected to prototyping area header pin 50. VNC2 PROG# connected to prototyping area header pin 49.

**Table 6.1: Multiplexer Configuration Settings**

## 7 Connecting to a PC Host

Connect a USB A/B cable to USB slave connector CN13 on the V2-EVAL board. Connect the other end to PC computer and power-up the board. The PC should detect that new hardware has been plugged into the PC and will launch the Hardware Wizard for installing the drivers. The driver installation procedure is outlined in the following section.

### 7.1 Driver Installation

The FTDI USB drivers are required for the USB slave interface to FT4232H on the V2-EVAL board. The latest drivers can be downloaded from the FTDI website <http://www.ftdichip.com/Drivers/VCP.htm>.

Installation instructions detailing all the steps required to install drivers on different operating systems are available from <http://www.ftdichip.com/Documents/InstallGuides.htm>. A summary of the installation steps for a Windows XP system are shown below.

**Upon connection, the New Hardware Wizard should produce the following screen shown in**

1. Figure 7.1.

As FTDI supply WHQL certified drivers a user may select the option 'Yes, this time only', which will cause the Hardware Wizard to download compatible FTDI drivers from the internet. However to avoid internet connectivity issues, users may carry out a manual installation using the following steps.



**Figure 7.1: Found New Hardware Wizard Screen**

2. With the manual installation, select the option to "Install from a list or specific location (Advanced)" as shown in Figure 7.2 below and then click "Next".



**Figure 7.2: Select installation option**

3. Select "Search for the best driver in these locations" and enter the file path in the combo-box ("C:\ CDM 2.06.00 WHQL Certified\CDM 2.06.00 WHQL Certified" in Figure 7.3 below) or browse to it by clicking the browse button. Once the file path has been entered in the box, click next to proceed.

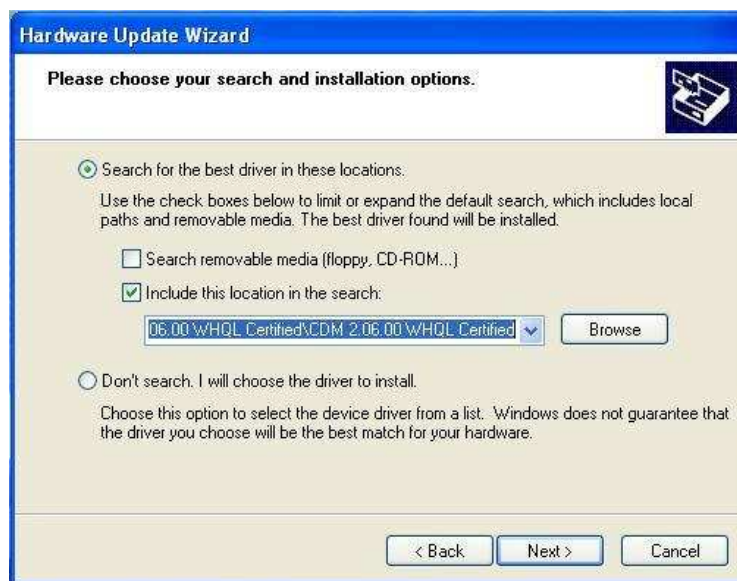

**Figure 7.3: Select location of the driver**

If installing a non-WHQL certified driver, then users may receive a warning, similar to Figure 7.4, stating that the driver has not passed Windows Logo testing. If the warning is received, click on 'Continue Anyway' to continue with the installation.



**Figure 7.4: Non-WHQL Driver Warning**

- In the next screen the Hardware Wizard will copy the the required driver files.



**Figure 7.5: Driver installation**

- In the next stage, the process will repeat another three times until all four ports on the FT4232H have been identified by the operating system. Windows should present a message to inform whether or not the drivers for each port have been successfully installed.
- To verify that the drivers have been installed successfully, open the Device Manager located in "Control Panel\System" then select the "Hardware" tab and click "Device Manger") and select "View > Devices by Connection". Each FT4232H port should appear as a "USB Serial Converter" under the "USB Serial Bus Controllers". Further under the "Ports" section four "USB Serial Ports" should be listed, as per Figure 7.6.

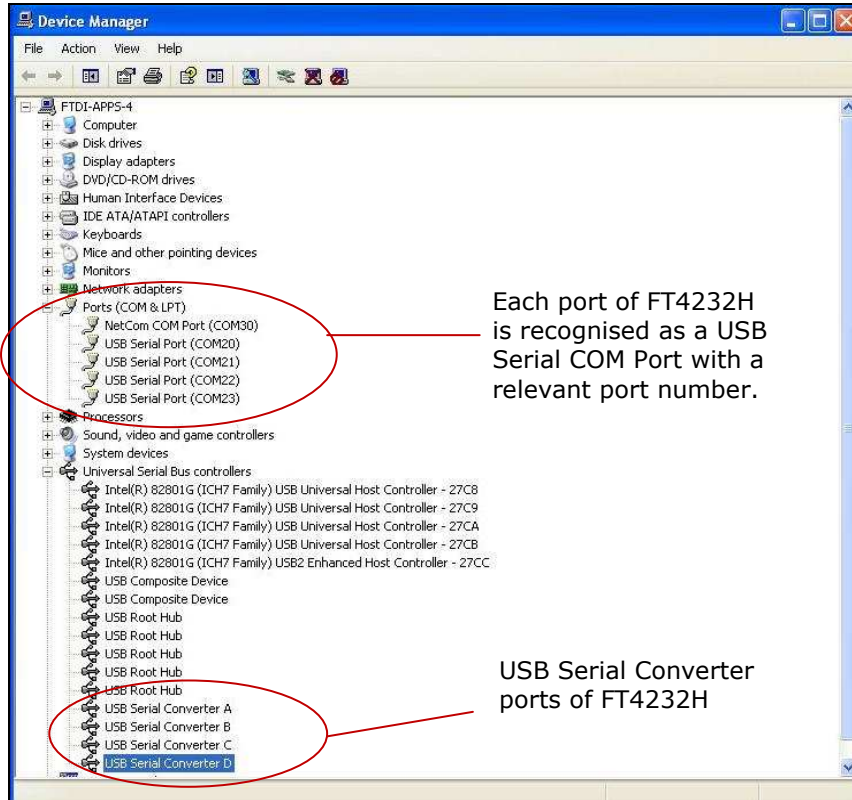

Figure 7.6: Device Manager Screen

## 8 V2-EVAL Software

The following section details instructions on how to install and use the V2-EVAL software terminal utility for the V2-EVAL board.

### 8.1 V2-EVAL Terminal Installation

A simple terminal application has been designed for use with the VNC2 V2-EVAL board. The application can be downloaded as part of the Vinculum II utilities available from:

<http://www.ftdichip.com/Firmware/VNC2tools.htm>

**Note:**

**The V2-EVAL terminal software is only supported under WindowXP, Vista and Windows 7 Operating Systems.**

To install the terminal application, simply double click on the installer and follow the installation instructions shown.

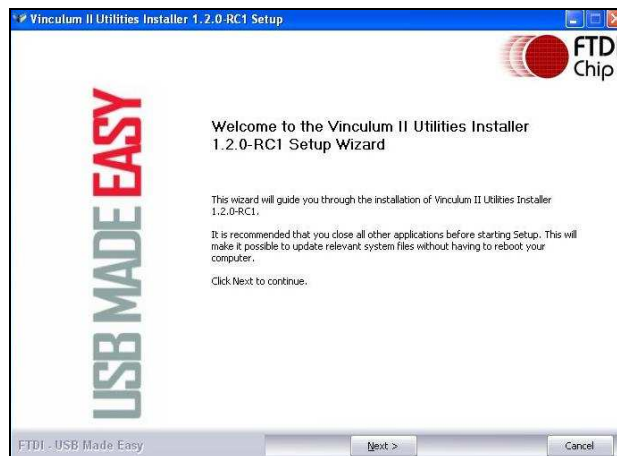
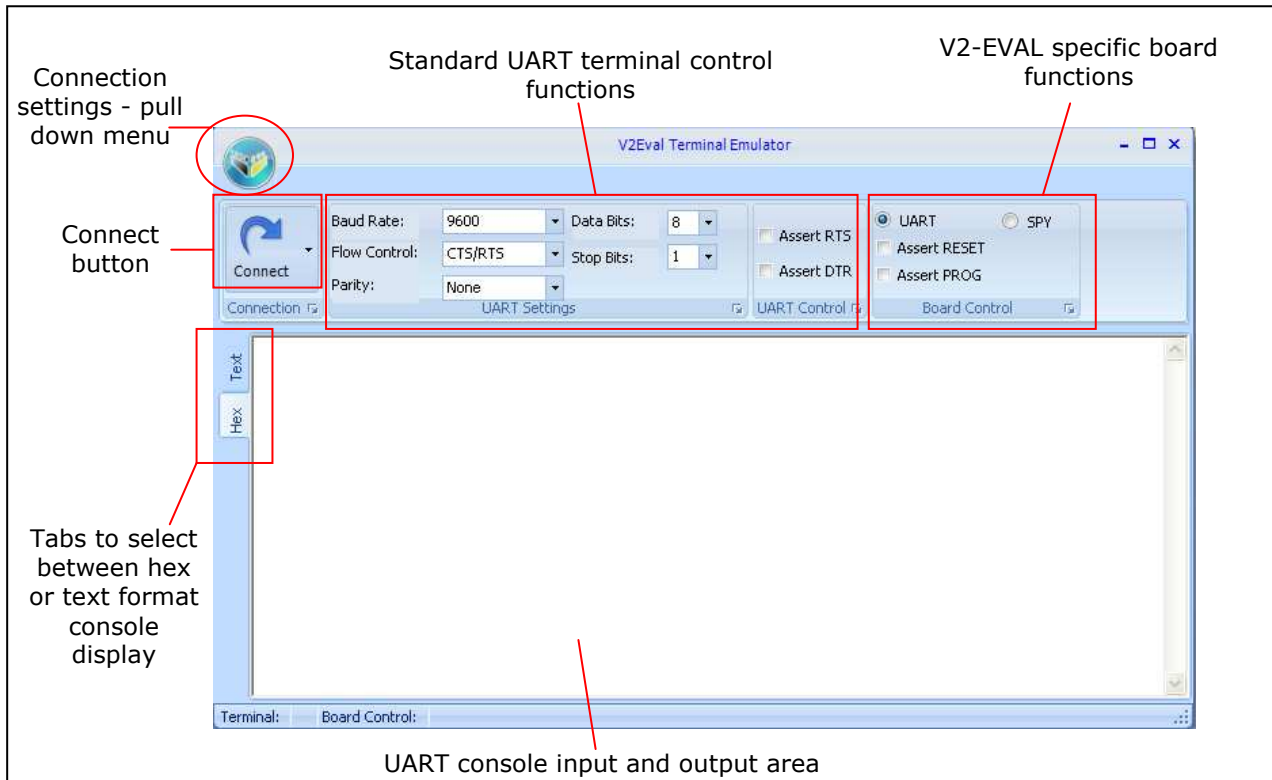

**Figure 8.1: Installer Introduction Screen**

Once installation is complete, the V2-EVAL application can be found and launched from 'Start -> 'All Programs -> FTDI -> Vinculum II Utilities' location.

## 8.2 Using V2-EVAL Terminal

The V2-EVAL terminal utility is a standard terminal application designed specifically to support the V2-EVAL board. The application provides communication to the UART interface on the VNC2 device and also provides commands to control some basic configuration functions on the V2-EVAL board. All communication and control commands are directed to the V2-EVAL board via the onboard FT4232H USB to quad channel serial converter.



**Figure 8.2: V2-EVAL Terminal Utility Features**

The V2-EVAL utility supports standard terminal commands and control functions. Pull down menus list different UART speeds, and data settings. On the top right hand section of the software a set of check buttons are available for controlling the V2-EVAL board. A summary of the function of each button on the V2-EVAL terminal utility is outlined below:

- **'Connect'** button – Connects and disconnects the terminal utility from the UART hardware.
- **'Assert RTS'** checkbox – Assert the Request To Send line on the UART interface.
- **'Asset DTR'** checkbox – Assert Data Terminal Ready line on the UART interface.
- **'UART'** mode button – Enables full UART TX and RX operation through the V2-EVAL terminal utility. Under the UART mode the select line of the V2-EVAL board multiplexer U4 is set to '0' forcing the FT4232H channel A to connect to UART interface on VNC2, as per the conditions outlined in Table 6.1.
- **'Spy'** mode button – The 'Spy' button sets the select line of the V2-EVAL board multiplexer U4 to '1', allowing the VNC2 UART interface to be controlled by an external device connected to the V2-EVAL board instead of the FT4232H, as per the conditions outlined in Table 6.1. Under this setting a user can connect to V2-EVAL board in 'Spy' mode via FT4232H channel C and observe VNC2 UART RX data in the terminal utility. 'Spy' mode is a read-only UART mode. Any user data input to the console under this mode is ignored.
- **'Assert RESET'** checkbox – When checked the software will enable the RESET# input signal on the VNC2 device. The checkbox is only available under UART mode.
- **'Assert PROG'** checkbox – When checked, the software will enable the PROG# input signal on the VNC2 device. The checkbox is only available under UART mode.

### 8.2.1.1 Using the V2-EVAL Terminal 'Spy' Mode

The V2-EVAL hardware and terminal utility supports a 'Spy' mode enabling the V2-EVAL terminal utility to display data from the VNC2 UART RXD pin, when the VNC2 is communicating with an external UART device. The following section outlines the steps to connect an external UART device to the VNC2 interface and enabling the 'Spy' mode.

1. The first step is to connect an external UART device to the VNC2 UART interface on the V2-EVAL board. An external device can be connected to the board via I/O connectors CN3 – CN11 or via the IOBUS connections in prototyping area P1.
2. The next step is to configure the IOMUX configuration settings on the VNC2 device to check that the UART connections reflect the physical I/O pins being used on the V2-EVAL hardware. The IOMUX settings are set within the VNC2 software code. A code example showing how to configure the VNC2 IOMUX settings is shown in Figure 8.3.

```

if (vos_get_package_type() == VINCULUM_II_64_PIN)
{
    // UART to V2EVAL board pins
    vos_iomux_define_output(39, IOMUX_OUT_UART_TXD); //UART Tx to pin 39
    vos_iomux_define_input(40, IOMUX_IN_UART_RXD); //UART Rx to pin 40
    vos_iomux_define_output(41, IOMUX_OUT_UART_RTS_N); //UART RTS# to pin 41
    vos_iomux_define_input(42, IOMUX_IN_UART_CTS_N); //UART CTS# to pin 42
}
else // VINCULUM_II_48_PIN
{
    // UART to V2EVAL board pins
    vos_iomux_define_output(31, IOMUX_OUT_UART_TXD); //UART Tx to pin 31
    vos_iomux_define_input(32, IOMUX_IN_UART_RXD); //UART Rx to pin 32
    vos_iomux_define_output(33, IOMUX_OUT_UART_RTS_N); //UART RTS# to pin 33
    vos_iomux_define_input(34, IOMUX_IN_UART_CTS_N); //UART CTS# to pin 34
}

```

**Figure 8.3: Example IOMUX configuration code**

The IOMUX configuration code can also be automatically generated using the Vinculum IOMUX configuration utility, which is available as part of the Vinculum II development tools.

The IOMUX settings are incorporated into the VNC2 firmware file as part of the VNC2 software development process. The settings are applied to the VNC2 when the firmware image is downloaded to the VNC2 device.

3. With the VNC2 device now programmed for UART operation, the next stage is to configure the V2-EVAL terminal utility for 'Spy' mode. Open the utility and connect to the board. In the 'Board Control' panel select the 'Spy' button. The step will reconfigure the onboard multiplexer. After changing to 'Spy' mode disconnect the terminal connection.

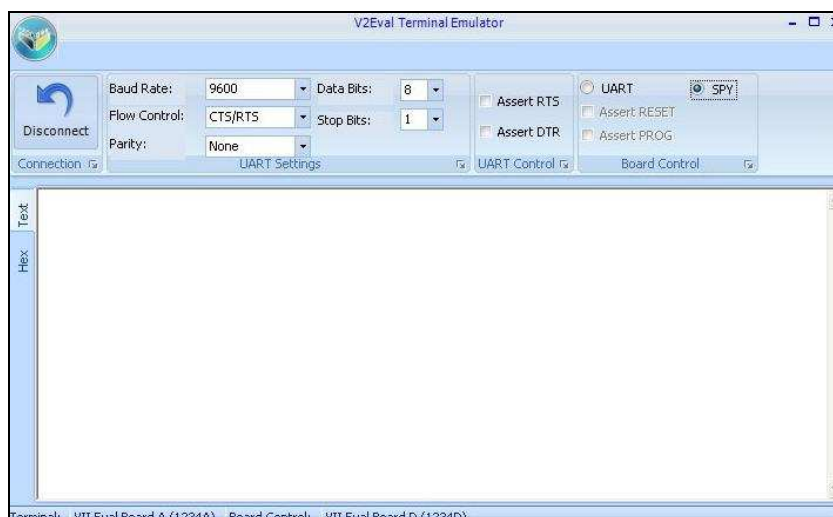

**Figure 8.4: V2-EVAL Terminal connection with 'Spy' connection enabled**



- Next open a connection to the 'Spy' channel on the V2-EVAL board. From the Vinculum logo pull down menu, select 'Connect to UART->VII Eval Board C' to open the UART connection to channel C on the FT4232H.

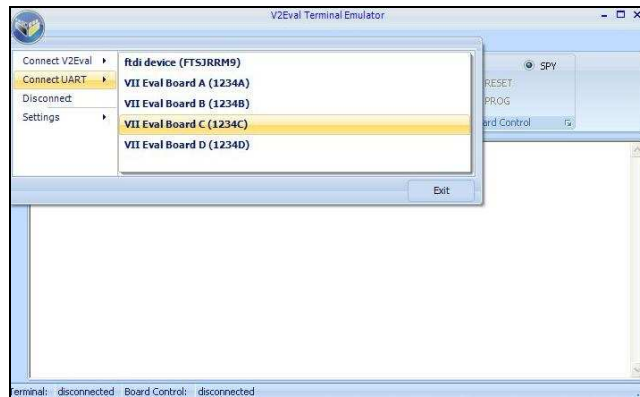

**Figure 8.5: Connect to 'Spy' channel on V2-EVAL board**

The V2-EVAL board and software is now ready to display 'Spy' data being sent to the VNC2 device from an external device.

An example displaying 'Spy' mode operation is shown in Figure 8.6. The example displays 'Spy' mode operation with an FTDI USB to 3.3V TTL level UART cable connected to the V2-EVAL board via connector CN10. The terminal connection on the right represents the terminal connection for the FTDI TTL USB cable showing data being transmitted from this console to the V2-EVAL terminal utility in the background.

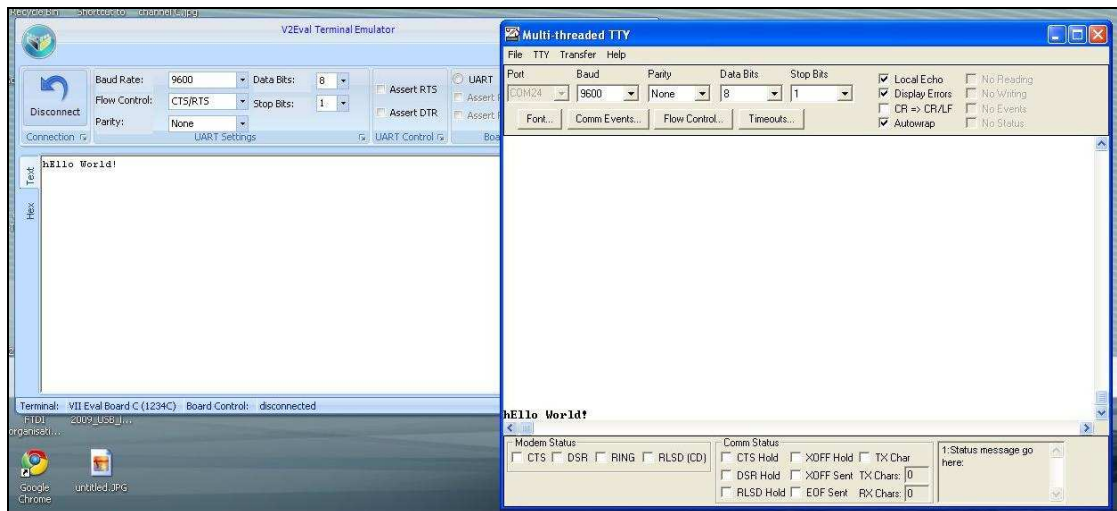
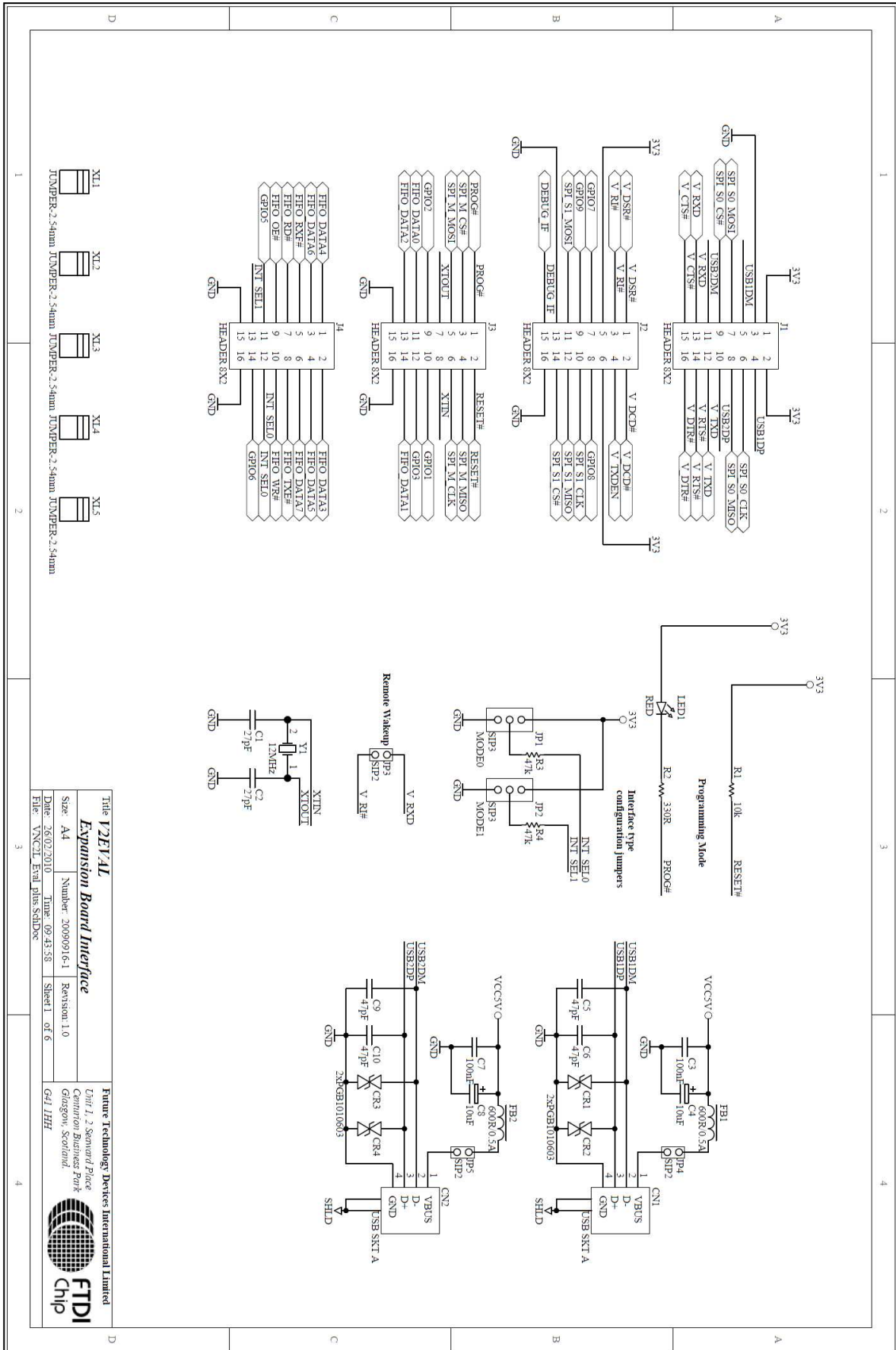

**Figure 8.6: 'Spy' mode operation**

## **9 Board Schematics.**

Schematics for the V2-EVAL board and VNC2 daughterboards are found in the following section.

## 9.1 V2-EVAL Board Schematics



Title: <b>V2-EVAL</b>		Figure Technology Devices International Limited	
Expansion Board Interface		Thp 1.2, Semoraj Place Gannoru Business Park Glasgow, Scotland.	
Size: A4	Number: 20090916-1	Revision: 1.0	FTDI Chip
Date: 26/02/2010	Time: 09:43:58	Sheet 1 of 6	
File: VNC211_Eval_plus_SchDoc			

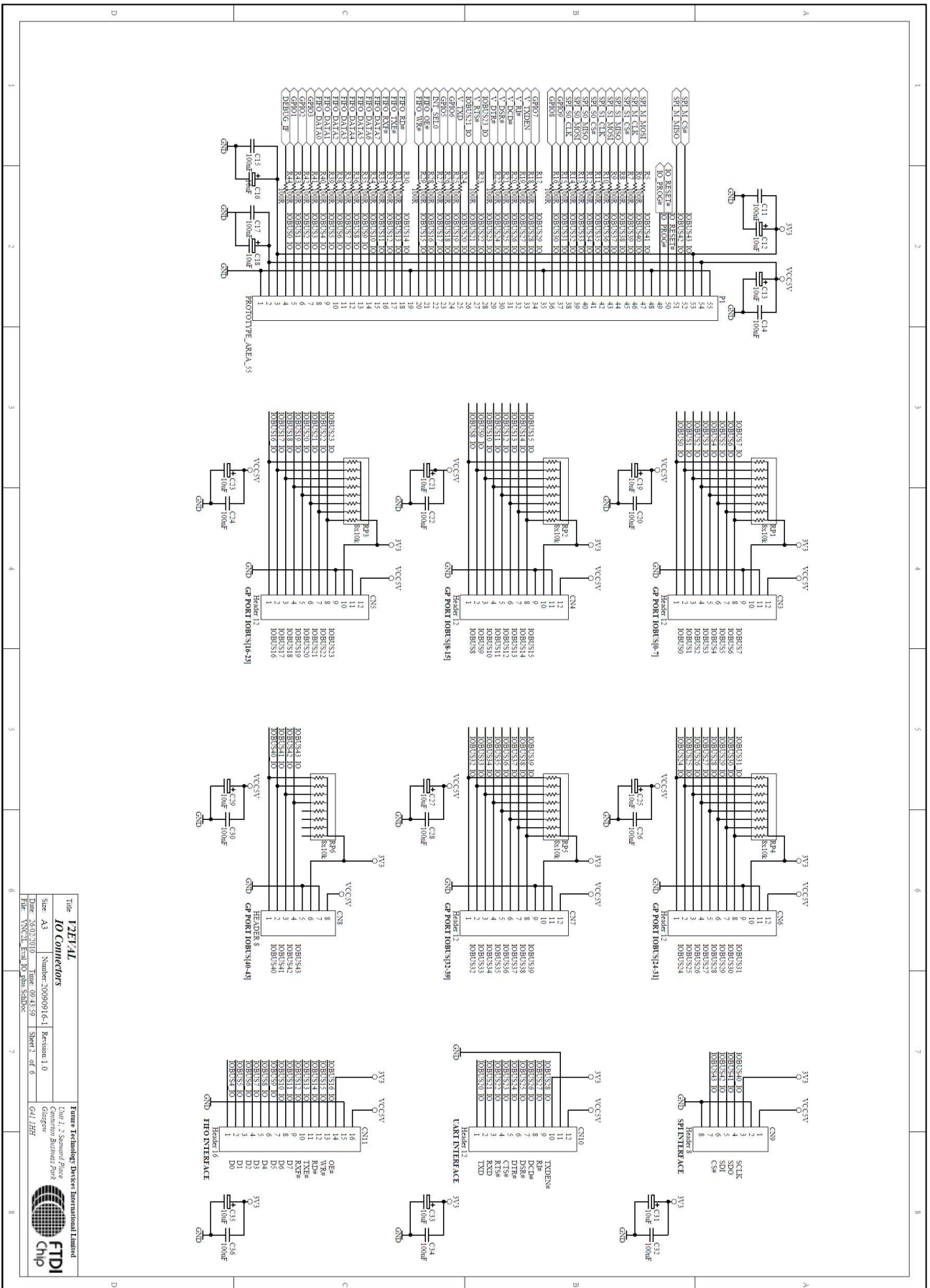

The <b>V2-EVAL</b>		Future Technology Devices International Limited	
<b>IO Connectors</b>		Unit 1, Semur Place	
Size: A3	Number: 20090916-1	Camden Business Park	
Date: 30/07/2010	Time: 09:43:59	Glasgow	
File: V2-EVAL_IO_Connectors	Sheet 2 of 6	Revision 1.0	
G41 JHR		FTDI Chip	

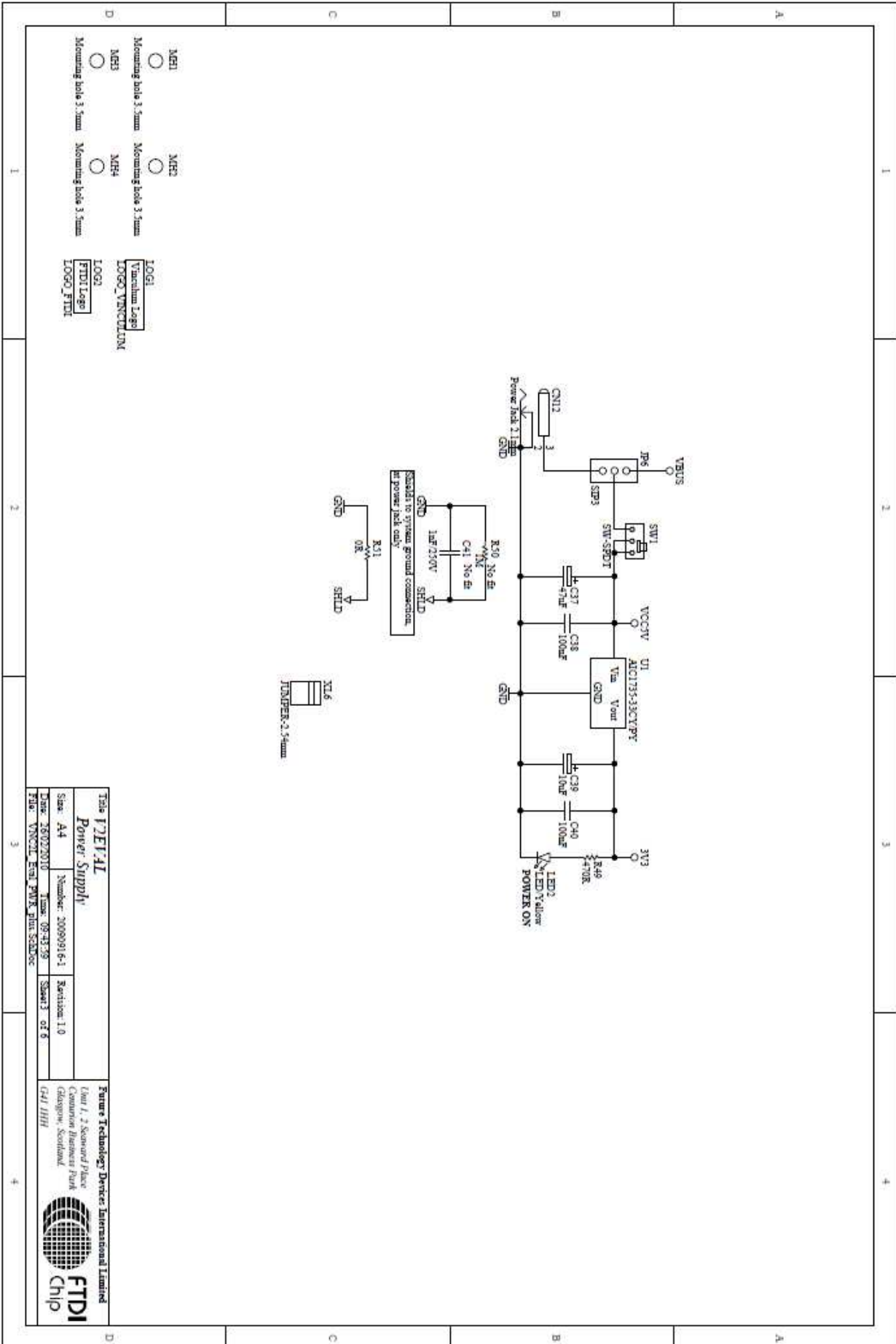

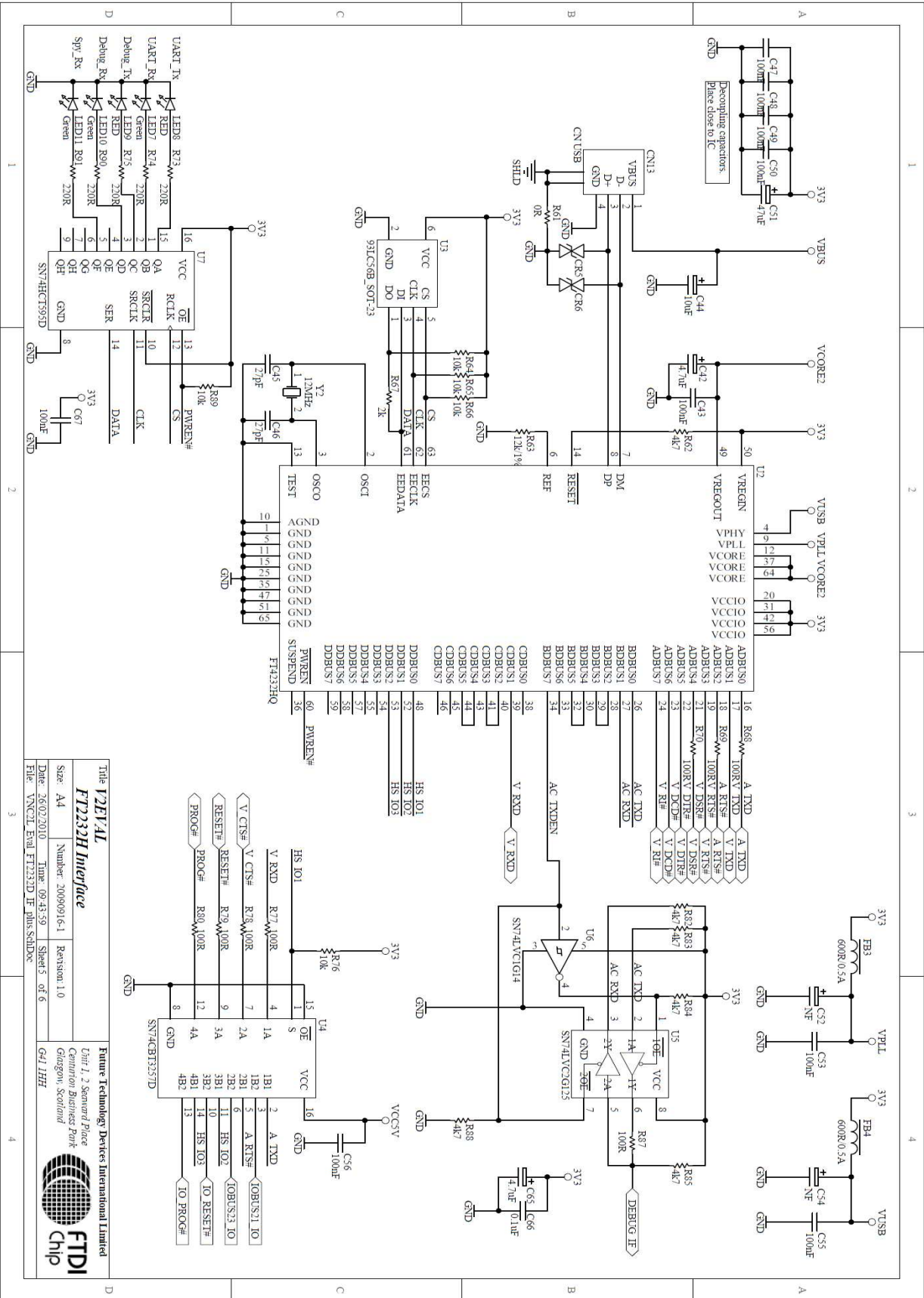

<b>Title</b> V2EVAL		<b>FT232RL Interface</b>	
Size: A4	Number: 20090916-1	Revision: 1.0	Sheet 5 of 6
Date: 26/02/2010	Time: 09:43:39	File: VNCCL_Eval_FT232RL_IF_plus.SchDoc	

<b>Future Technology Devices International Limited</b>		<b>FTDI Chip</b>	
Unit 1, 2 Semoral Place		Campton Business Park	
Glasgow, Scotland		Glasgow, Scotland	
G41 1JH		G41 1JH	



## 9.2 VNC2 Daughterboard - 32-pin QFN Schematic

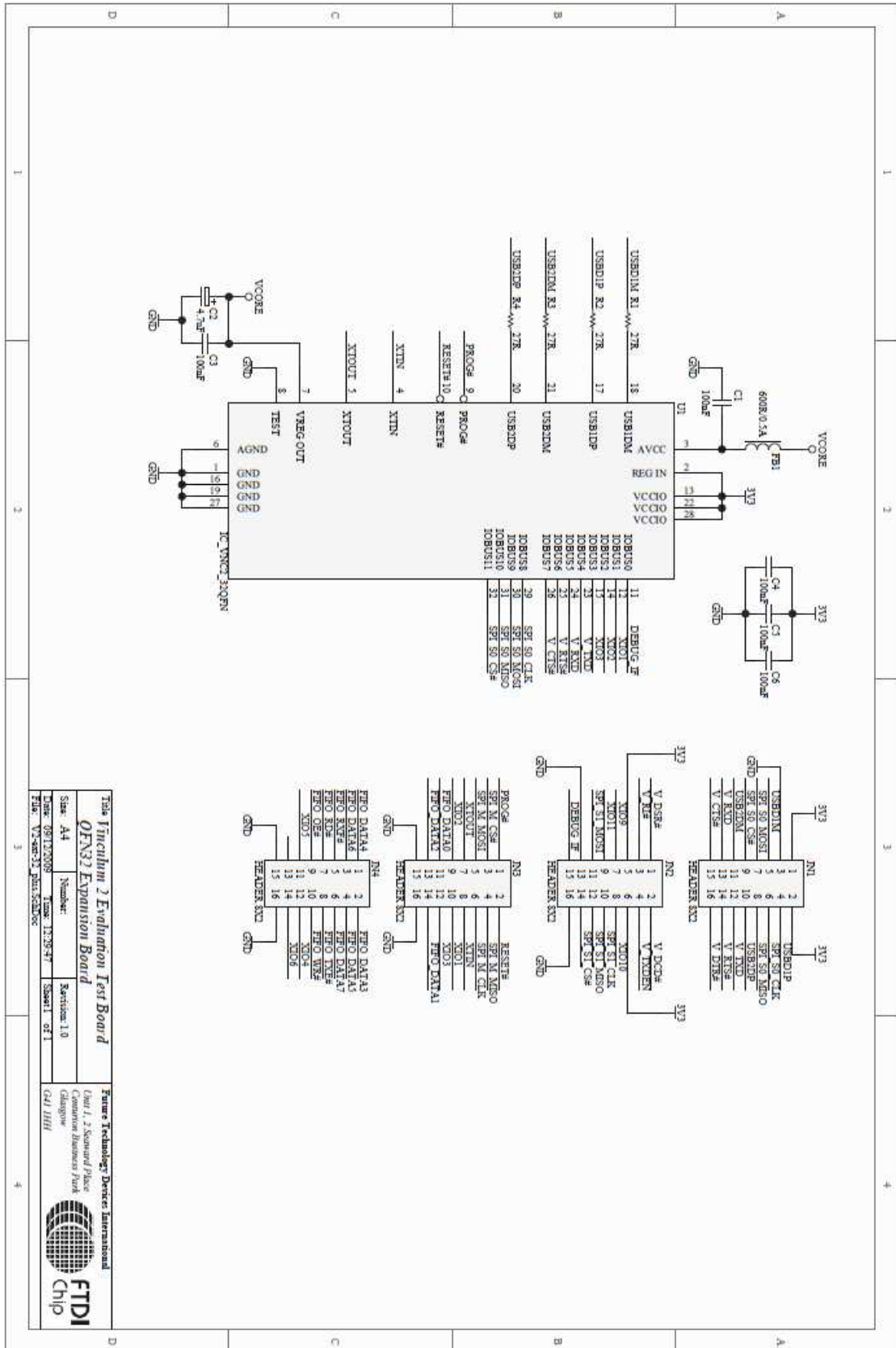



### 9.3 VNC2 Daughterboard - 48-pin QFN Schematic

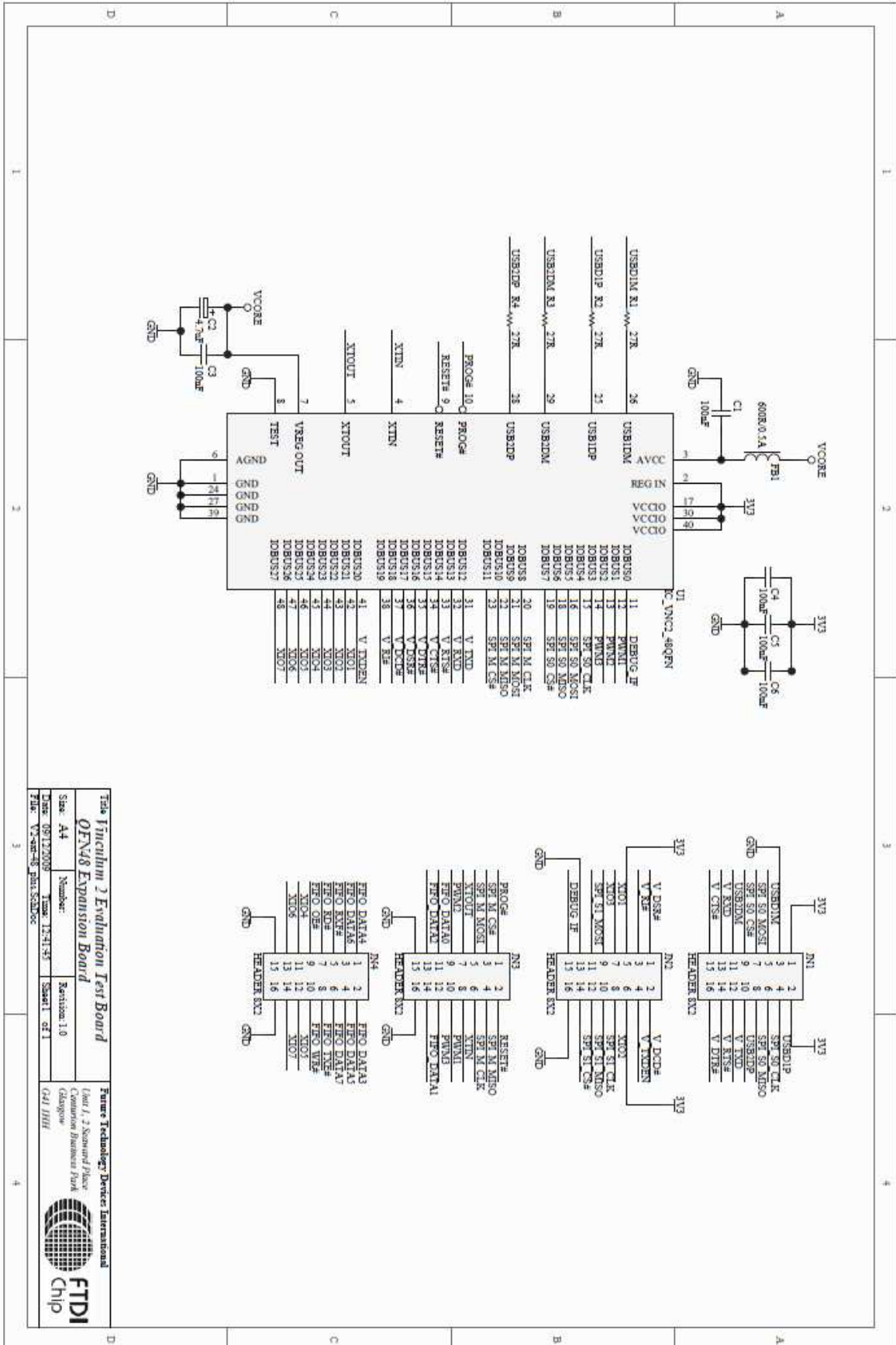

This Vinculum II Evaluation Test Board  
**QFN48 Expansion Board**  
 Size: A4 Number: Revision: 1.0  
 Date: 09/12/2008 Trace: 1:4:43 Serial: 021  
 File: V2-eval-48-pin-sch.doc

Future Technology Devices International  
 Unit 1, 2 Second Place  
 Canton Business Park  
 Chip



### 9.4 VNC2 Daughterboard - 64-pin QFN Schematic

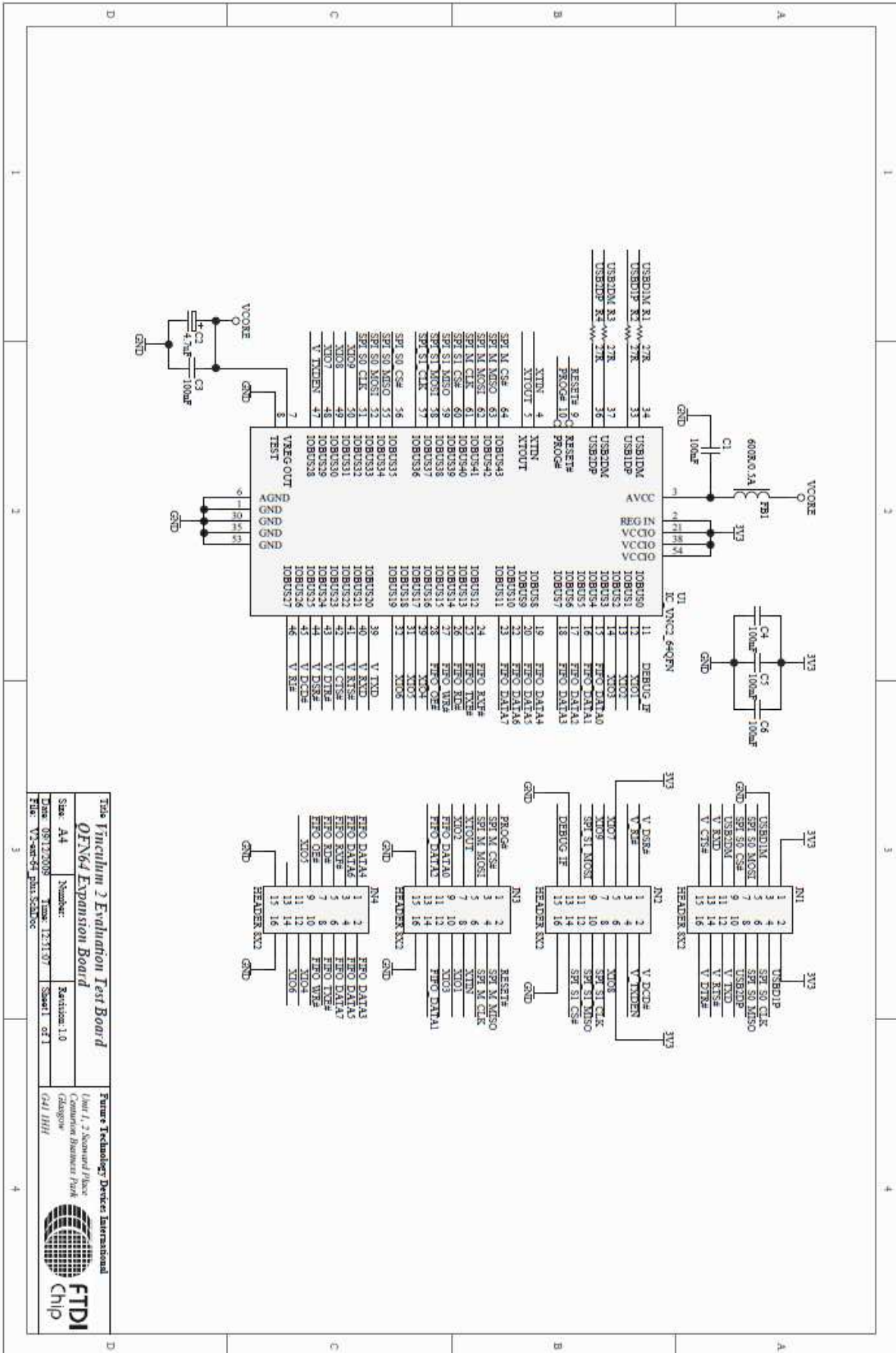

### 10 V2-EVAL Board Assembly Drawing

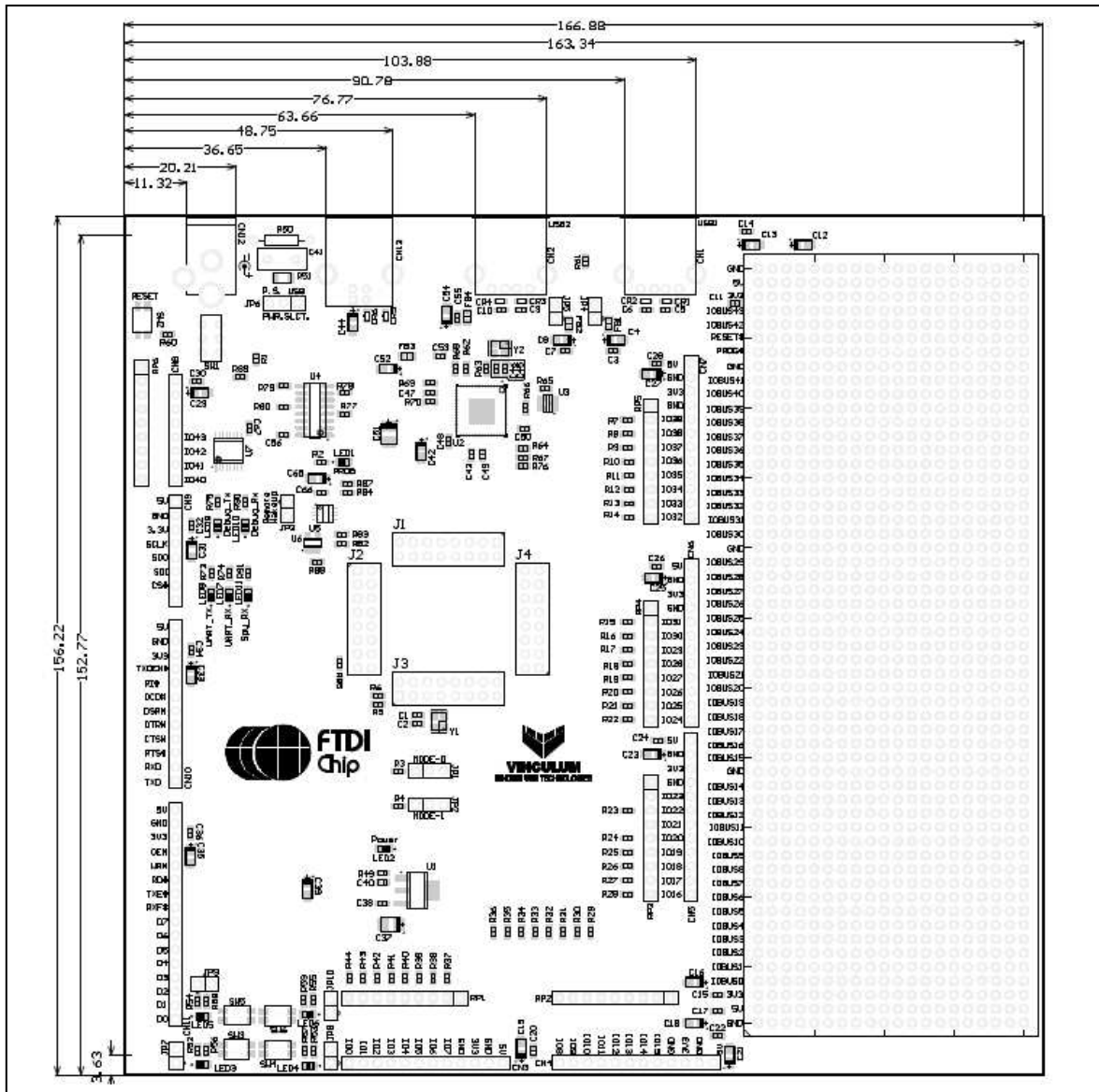

Dimensions in mm.Tolerance is ±0.1mm

## Contact Information

### Head Office – Glasgow, UK

Future Technology Devices International Limited  
Unit 1, 2 Seaward Place,  
Centurion Business Park  
Glasgow, G41 1HH  
United Kingdom  
Tel: +44 (0) 141 429 2777  
Fax: +44 (0) 141 429 2758

E-mail (Sales) [sales1@ftdichip.com](mailto:sales1@ftdichip.com)  
E-mail (Support) [support1@ftdichip.com](mailto:support1@ftdichip.com)  
E-mail (General Enquiries) [admin1@ftdichip.com](mailto:admin1@ftdichip.com)  
Web Site URL <http://www.ftdichip.com>  
Web Shop URL <http://www.ftdichip.com>

### Branch Office – Taipei, Taiwan

Future Technology Devices International Limited (Taiwan)  
2F, No 516, Sec. 1 NeiHu RoIOBUS  
Taipei 114  
Taiwan, R.O.C.  
Tel: +886 (0) 2 8791 3570  
Fax: +886 (0) 2 8791 3576

E-mail (Sales) [tw.sales1@ftdichip.com](mailto:tw.sales1@ftdichip.com)  
E-mail (Support) [tw.support1@ftdichip.com](mailto:tw.support1@ftdichip.com)  
E-mail (General Enquiries) [tw.admin1@ftdichip.com](mailto:tw.admin1@ftdichip.com)  
Web Site URL <http://www.ftdichip.com>

### Branch Office – Hillsboro, Oregon, USA

Future Technology Devices International Limited (USA)  
7235 NW Evergreen Parkway, Suite 600  
Hillsboro, OR 97123-5803  
USA  
Tel: +1 (503) 547 0988  
Fax: +1 (503) 547 0987

E-Mail (Sales) [us.sales@ftdichip.com](mailto:us.sales@ftdichip.com)  
E-Mail (Support) [us.support@ftdichip.com](mailto:us.support@ftdichip.com)  
E-Mail (General Enquiries) [us.admin@ftdichip.com](mailto:us.admin@ftdichip.com)  
Web Site URL <http://www.ftdichip.com>

### Branch Office – Shanghai, China

Future Technology Devices International Limited (China)  
Room 408, 317 Xianxia RoIOBUS,  
ChangNing District,  
ShangHai, China

Tel: +86 (21) 62351596  
Fax: +86(21) 62351595

E-Mail (Sales): [cn.sales@ftdichip.com](mailto:cn.sales@ftdichip.com)  
E-Mail (Support): [cn.support@ftdichip.com](mailto:cn.support@ftdichip.com)  
E-Mail (General Enquiries): [cn.admin1@ftdichip.com](mailto:cn.admin1@ftdichip.com)  
Web Site URL <http://www.ftdichip.com>

### Distributor and Sales Representatives

Please visit the Sales Network page of the FTDI Web site for the contact details of our distributor(s) and sales representative(s) in your country.

## Appendix A – List of Figures and Tables

### List of Figures

Figure 1.1 - V2-EVAL Motherboard(left) with Daughterboard Module(right) .....	3
Figure 3.1 V2-EVAL Board Layout .....	7
<b>Figure 3.2 V2-EVAL Board Block Diagram</b> .....	8
Figure 4.1 V2-EVAL Board with VNC2 Daughterboard Installed .....	11
<b>Figure 4.2 Power connector with Jumper JP6</b> .....	12
<b>Figure 5.1 Power Select Jumper Configuration for USB Power</b> .....	13
<b>Figure 5.2 GPIO[0:7] Connector CN3</b> .....	14
<b>Figure 5.3 GPIO[8:15] Connector CN4</b> .....	15
<b>Figure 5.4 GPIO[16:23] Connector CN5</b> .....	16
<b>Figure 5.5 GPIO[24:31] Connector CN6</b> .....	17
<b>Figure 5.6 GPIO[32:39] Connector CN7</b> .....	18
<b>Figure 5.7 GPIO[32:39] Connector CN8</b> .....	19
<b>Figure 5.8 SPI Connector CN9</b> .....	20
<b>Figure 5.9 UART Connector CN10</b> .....	21
<b>Figure 5.10 FIFO Connector CN11</b> .....	22
<b>Figure 5.11 Prototyping area P1</b> .....	23
<b>Figure 5.12 USB1 Interface CN1</b> .....	26
<b>Figure 5.13 USB2 Interface CN2</b> .....	27
<b>Figure 5.14 GPIO Jumper pins, JP1, JP2</b> .....	28
<b>Figure 5.15 User LEDs</b> .....	29
<b>Figure 5.16 LED Enable/Disable jumpers</b> .....	30
<b>Figure 5.17 User Push Button Switches</b> .....	30
<b>Figure 5.18 USB Power Enable Jumpers JP4 and JP5</b> .....	31
<b>Figure 5.19 Remote Wakeup Jumper</b> .....	32
<b>Figure 5.20 Reset Switch</b> .....	33
<b>Figure 5.21 'PROG' LED</b> .....	33
<b>Figure 5.22 VNC2 Daughterboard Connector J1</b> .....	34
<b>Figure 5.23 VNC2 Daughterboard Connector J2</b> .....	35
<b>Figure 5.24 VNC2 Daughterboard Connector J3</b> .....	36
<b>Figure 5.25 VNC2 Daughterboard Connector J4</b> .....	37
Figure 6.1: FT4232H Configuration .....	39
Figure 7.1: Found New Hardware Wizard Screen.....	41
Figure 7.2: Select installation option .....	42
Figure 7.3: Select location of the driver .....	42
Figure 7.4: Non-WHQL Driver Warning .....	43
Figure 7.5: Driver installation .....	43
Figure 7.6: Device Manager Screen.....	44
Figure 8.1: Installer Introduction Screen .....	45
Figure 8.2: V2-EVAL Terminal Utility Features .....	46

---

<b>Figure 8.3: Example IOMUX configuration code .....</b>	<b>47</b>
<b>Figure 8.4: V2-EVAL Terminal connection with 'Spy' connection enabled .....</b>	<b>47</b>
<b>Figure 8.5: Connect to 'Spy' channel on V2-EVAL board.....</b>	<b>48</b>
<b>Figure 8.6: 'Spy' mode operation .....</b>	<b>48</b>

## List of Tables

Table 1.1	Document References .....	4
Table 1.2	Acronyms and Abbreviations.....	5
<b>Table 3.1</b>	<b>V2-Eval Board Components .....</b>	<b>9</b>
<b>Table 3.2</b>	<b>V2-Eval Board Interfaces.....</b>	<b>10</b>
<b>Table 5.1</b>	<b>GPIO[0:7] port connector CN3 .....</b>	<b>14</b>
<b>Table 5.2</b>	<b>GPIO[8:15] connector CN4.....</b>	<b>15</b>
<b>Table 5.3</b>	<b>GPIO port connector CN5 .....</b>	<b>16</b>
<b>Table 5.4</b>	<b>GPIO port connector CN6 .....</b>	<b>17</b>
<b>Table 5.5</b>	<b>GPIO port connector CN7 .....</b>	<b>18</b>
<b>Table 5.6</b>	<b>GPIO port connector CN8 .....</b>	<b>19</b>
<b>Table 5.7</b>	<b>SPI Port Connector CN9 .....</b>	<b>20</b>
<b>Table 5.8</b>	<b>UART Interface Connector CN10.....</b>	<b>21</b>
<b>Table 5.9</b>	<b>FIFO Interface Connector CN11.....</b>	<b>22</b>
<b>Table 5.10</b>	<b>Prototyping Area Pinout .....</b>	<b>25</b>
<b>Table 5.11</b>	<b>USB1 Host/Slave Connector CN1 .....</b>	<b>26</b>
<b>Table 5.12</b>	<b>USB2 Host / Slave connector CN2 .....</b>	<b>27</b>
<b>Table 5.13</b>	<b>GPIO jumpers JP1, JP2.....</b>	<b>28</b>
<b>Table 5.14</b>	<b>Monitor Interface Select – VNC1L Firmware Backwards Compatibility .....</b>	<b>28</b>
<b>Table 5.15</b>	<b>User LED connections .....</b>	<b>29</b>
<b>Table 5.16</b>	<b>LED Enable/Disable Jumpers.....</b>	<b>30</b>
<b>Table 5.17</b>	<b>User Switches.....</b>	<b>30</b>
<b>Table 5.18</b>	<b>Connector J1 Pinout .....</b>	<b>34</b>
<b>Table 5.19</b>	<b>Connector J2 Pinout .....</b>	<b>35</b>
<b>Table 5.20</b>	<b>Connector J3 Pinout .....</b>	<b>36</b>
<b>Table 5.21</b>	<b>Connector J4 Pinout .....</b>	<b>37</b>
<b>Table 6.1:</b>	<b>Multiplexer Configuration Settings .....</b>	<b>40</b>

## Appendix B – Revision History

Rev 1.0	First Release	15th April 2010
Rev 2.0	Second Release	27 <sup>th</sup> July 2010