

RoHS  **SL1021A/B, SL1024A/B and PMT8 Series**



Description

GDT circuit protection devices dissipate electrical surge energy safely within a contained plasma gas. Commonly used to help protect sensitive telecom and networking equipment and lines, GDTs protect from damage that may result from lightning strikes and equipment switching operations.

The Littelfuse GDT series described in this document are available in a variety of leaded and surface mount forms and offered with and without optional fail-safe clip. Please refer to the electrical specifications, dimension and packaging options section of this document for additional information.

SL1021A/B and SL1024A/B Series:

SL1021A/B and SL1024A/B series GDTs are designed to offer high levels of performance on fast rising transients in the range of 100V/μS to 1KV/μS, which are those most likely created by induced lightning disturbances.

These devices feature ultra low capacitance (typically 1.5pF or less) and are extremely robust with SL102xA devices able to divert a 10,000 Amp pulse without destruction, and SL102xB suffix devices able to divert a 20,000 Amp pulse without destruction.

These series offer optimized internal geometry which provide low insertion loss at high frequencies, ideal for the protection of broadband and other high speed transmission equipment.

PMT8 Series:

PMT8 GDT's are telecom grade devices designed to meet the recommendations in CCITT-K12 and Bellcore GR-1361-CORE. The three electrode configuration is used in applications where simultaneous crowbar action of two signal lines is required.

Agency Approvals

AGENCY	AGENCY FILE NUMBER
	E128662

3 Electrode GDT Graphical Symbol

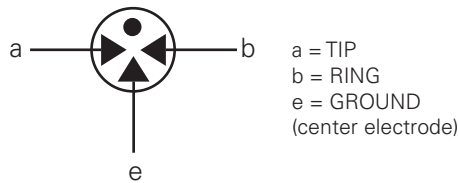

Features

- RoHS compliant
- Low insertion loss
- Excellent response to fast rising transients
- Ultra low capacitance
- 10KA (A suffix devices) / 20KA (B suffix devices) surge capability tested with 8/20μs pulse as defined by IEC 61000-4-5
- Available with thermal failsafe option (add 'F' suffix to part number)

Applications

SL1021 / SL1024:

- Broadband equipment
- ADSL equipment
- XDSL equipment
- Satellite and CATV equipment
- Splitters
- General telecom equipment

PMT8:

- Telecom network interfaces
- Telephone line cards
- Repeaters
- Modems
- Line test equipment

Product Characteristics

Materials	Dull Tin Plate 17.5 ± 12.5 Microns. with ceramic insulator
Product Marking	'LF' mark, voltage & date code: SL102xA - Red/White text SL102xB & PMT8 - Blue/White text
Glow to arc transition current	~ 1Amp
Glow Voltage	~60-200 Volts
Storage and Operation Temperature	-40 to +90°C
Transverse Voltage (Delay Time)	< 0.2μSec (Tested to ITU-T Rec. K.12)
Arc Voltage	~10 to 35 Volts
Holdover Voltage	<150mS (Tested to ITU-T Rec. K.12)

Electrical Characteristics

Device Specifications (at 25°C)							Life Ratings					
Part Number*	DC Voltage 100V/Sec.			DC Voltage 100 V/μSec.	DC Voltage 1kV/μSec.	Capacitance (@1Mhz)	Insulation Resistance	AC Current 50Hz 1Sec.x10 ¹	Surge Current 8/20μSec x10 ¹	Max Single Surge 8/20μSec ¹	Max Single Surge 10/350μSec ¹	Surge Life 10/1000 μSecx300 ¹
	MIN	TYP	MAX									
SL1021A090 SL1024A090 SL1021B090 SL1024B090 PMT 8 090	72	90	108	500	650	<1.5pF	>10 ¹⁰ Ω (at 50V)	10Amps	10kA ² 20kA ³	15kA ² 25kA ³	4kA ² 5kA ³	200Amps
SL1021A145 SL1024A145 SL1021B145 SL1024B145	116	145	174		600						2.5kA ² 5kA ³	
SL1021A150 SL1024A150 SL1021B150 SL1024B150	120	150	180		650							
SL1021A200	150	200	250		700							
SL1021A230 SL1024A230 SL1021B230 SL1024B230 PMT 8 230	184	230	276	450	850	>10 ¹⁰ Ω (at 100V)	10Amps	10kA ² 20kA ³	15kA ² 25kA ³	2.5kA ² 5kA ³	200Amps	
SL1021A250 SL1024A250 SL1021B250 SL1024B250 PMT 8 250	200	250	300	500	900							
SL1021A260 SL1024A260 SL1021B260 SL1024B260	210	260	310	550	950	>10 ¹⁰ Ω (at 100V)	10Amps	10kA ² 20kA ³	15kA ² 25kA ³	2.5kA ² 5kA ³	200Amps	
SL1021A300 SL1024A300 SL1021B300 SL1024B300	240	300	360	650	950							
SL1021A350 SL1024A350 SL1021B350 SL1024B350 PMT 8 350	280	350	420	700	950	>10 ¹⁰ Ω (at 100V)	10Amps	10kA ² 20kA ³	15kA ² 25kA ³	2.5kA ² 5kA ³	200Amps	
SL1021A400 SL1024A400 SL1021B400 SL1024B400 PMT 8 400	320	400	480	850	950							
SL1021A420 SL1024A420 SL1021B420 SL1024B420	345	420	500	850	950	>10 ¹⁰ Ω (at 100V)	10Amps	10kA ² 20kA ³	15kA ² 25kA ³	2.5kA ² 5kA ³	200Amps	
SL1021A450 SL1024A450 SL1021B450 SL1024B450	360	450	540	900	1000							
SL1021A500 SL1024A500 SL1021B500 SL1024B500	400	500	600	950	1100	>10 ¹⁰ Ω (at 100V)	10Amps	10kA ² 20kA ³	15kA ² 25kA ³	2.5kA ² 5kA ³	200Amps	
SL1021A600 SL1024A600	480	600	720	1000	1200							

NOTES:

*Max capacitance is 1.5 pF, measured at 1 MHz.

1. Total current through centre electrode, tested in accordance with ITU-T Rec K.12
2. SL A series
3. SL B series & PMT 8 series

Time vs. Current for Failsafe

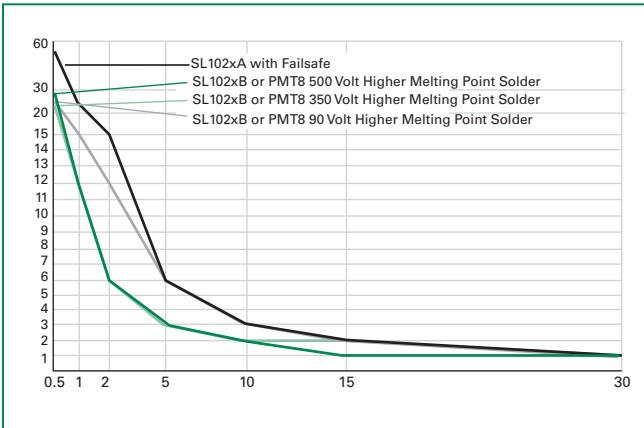

Voltage vs. Time Characteristic

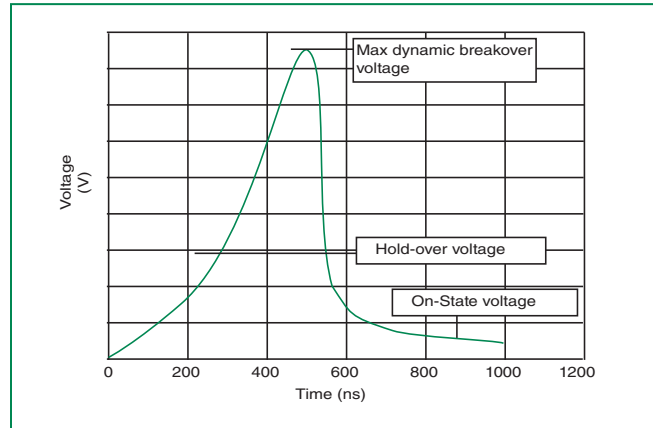

Soldering Parameters - Reflow Soldering (Surface Mount Devices)

Reflow Condition		Pb – Free assembly
Pre Heat	- Temperature Min ($T_{s(min)}$)	150°C
	- Temperature Max ($T_{s(max)}$)	200°C
	- Time (Min to Max) (t_s)	60 – 180 secs
Average ramp up rate (Liquidus Temp (T_L) to peak)		3°C/second max
$T_{s(max)}$ to T_L - Ramp-up Rate		5°C/second max
Reflow	- Temperature (T_L) (Liquidus)	217°C
	- Temperature (t_L)	60 – 150 seconds
Peak Temperature (T_p)		260 ^{+0/-5} °C
Time within 5°C of actual peak Temperature (t_p)		10 – 30 seconds
Ramp-down Rate		6°C/second max
Time 25°C to peak Temperature (T_p)		8 minutes Max.
Do not exceed		260°C

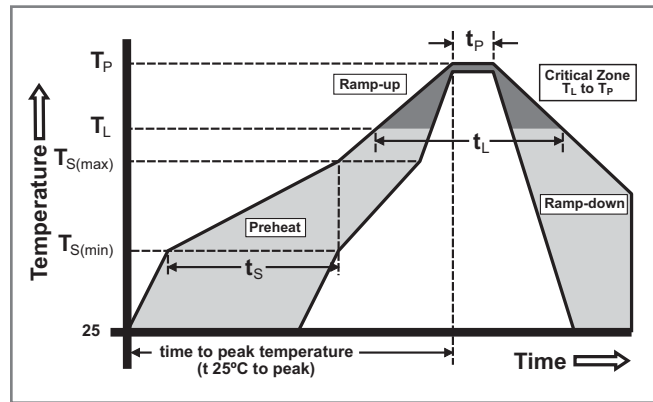

Soldering Parameters - Hand Soldering

Solder Iron Temperature: 350° C +/- 5°C
 Heating Time: 5 seconds max.

Soldering Parameters - Wave Soldering (Thru-Hole Devices)

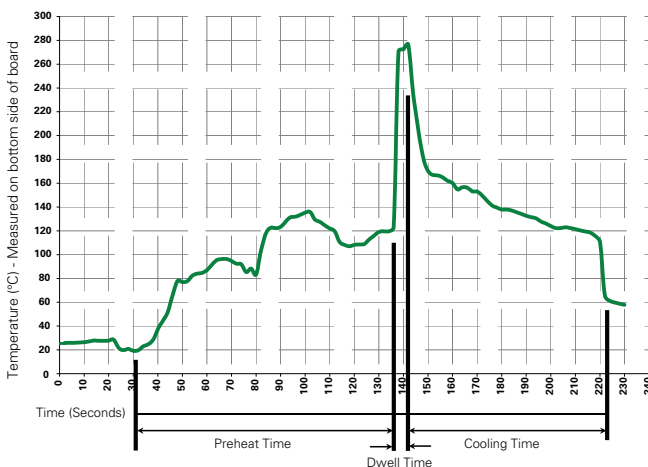

Recommended Process Parameters:

Wave Parameter	Lead-Free Recommendation
Preheat: (Depends on Flux Activation Temperature) (Typical Industry Recommendation)	
Temperature Minimum:	100° C
Temperature Maximum:	150° C
Preheat Time:	60-180 seconds
Solder Pot Temperature:	280° C Maximum
Solder Dwell Time:	2-5 seconds

Note: Surge Arrestors with a Failsafe mechanism should be individually examined after soldering

Device Dimensions

NOTE: Failsafe option dimensions shown in green.

Shaped Radial Ledged Devices:

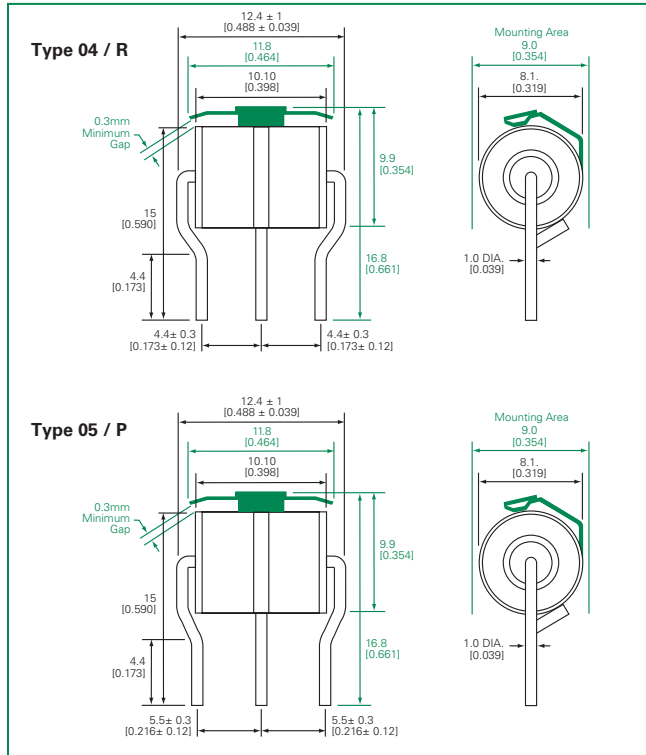

Surface Mount Devices:

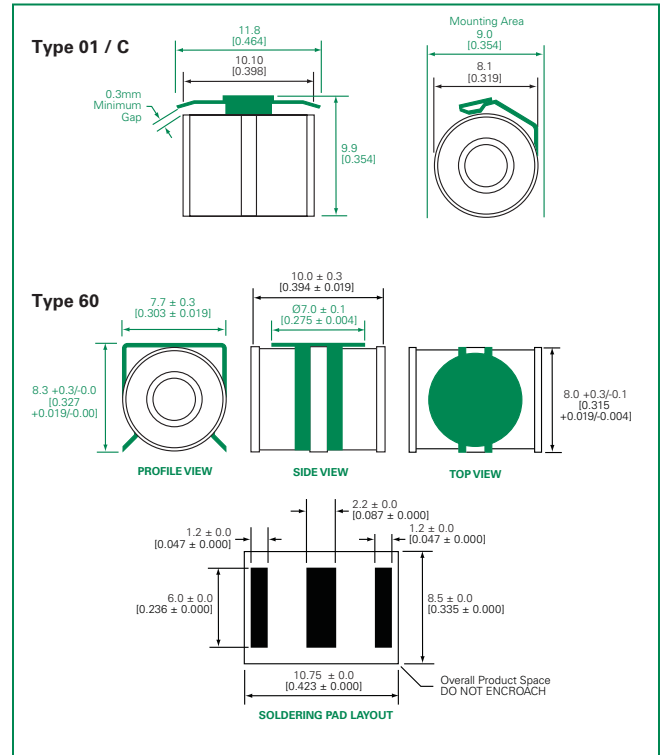

Straight "T" Ledged Devices:

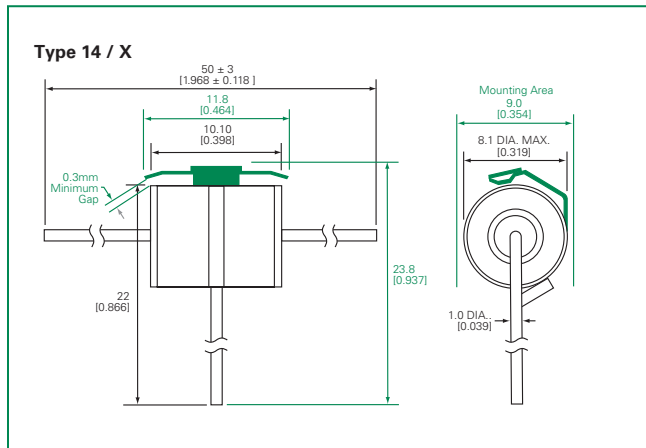

Straight Radial Ledged Devices:

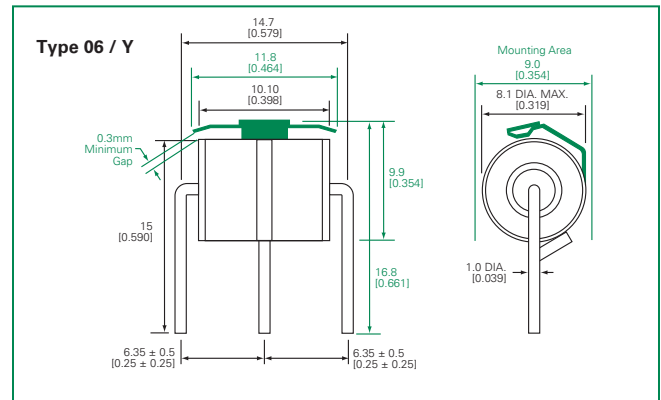

Part Numbering System and Ordering Information

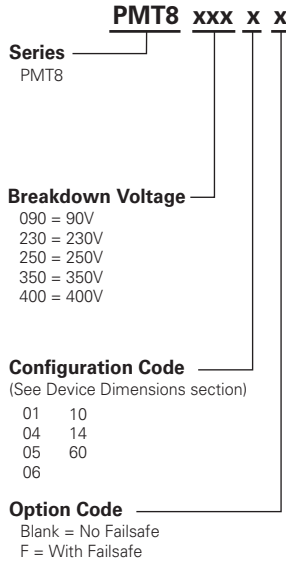
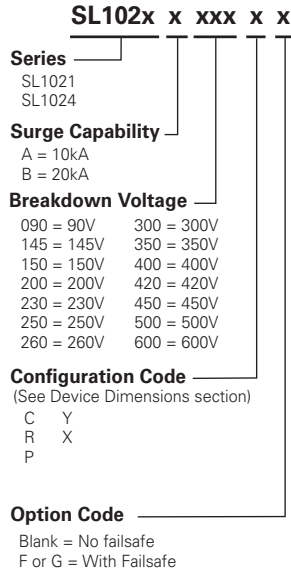

Packaging

Device Type	Description	Quantity
Type 01 / C	100pcs/tray x 5 trays per carton	500
Type 04 / R	100pcs/tray x 5 trays per carton	500
Type 05 / P	100pcs/tray x 5 trays per carton	500
Type 06 / Y	100pcs/tray x 5 trays per carton	500
Type 14 / X	50pcs/tray x 5 trays per carton	250
Type 60	500pcs/reel* x 10 reels per carton	5000

* For tape and reel specifications, please contact factory.