

PulseGuard® Suppressors

Surface Mount Polymeric ESD Suppressors

PGB Series 0805 ESD Suppressor

Product Overview

PulseGuard ESD Suppressors help protect sensitive electronic equipment against electrostatic discharge (ESD). They supplement the on-chip protection of integrated circuitry and are best suited for low-voltage, high-speed applications where low capacitance is important. Data ports utilizing such high-speed protocols as USB 2.0, IEEE1394 and InfiniBandSM can benefit from this new technology. PulseGuard suppressors use polymer composite materials to suppress fast-rising ESD transients (as specified in IEC 61000-4-2 and MIL-STD-883E).

Features

- Ultra-low capacitance
- Low leakage current
- Fast response time
- 4-lines of protection
- Bi-directional
- Withstands multiple ESD strikes
- Based on industry standard 2012 package
- Compatible with pick-and-place processes
- Available in 1,000 and 5,000 piece reels (EIA-RS481)

Typical Applications

- Servers
- Laptop/Desktop Computers
- Network Hardware
- Computer Peripherals
- Digital Cameras
- External Storage

Ordering Information

CATALOG NUMBER	PIECES PER REEL
PGB0040805MR	1,000
PGB0040805NR	5,000

Design Consideration

Because of the fast rise-time of the ESD transient, placement of PulseGuard suppressors is a key design consideration. To achieve optimal ESD suppression, the devices should be placed on the circuit board as close to the source of the ESD transient as possible. Install PulseGuard suppressors directly behind the connector so that they are the first board-level circuit component encountered by the ESD transient. They are connected from signal/data line to ground.



Reference Dimensions:

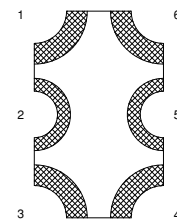
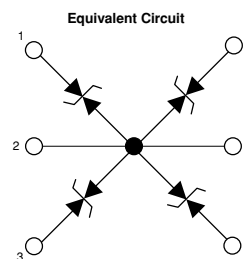
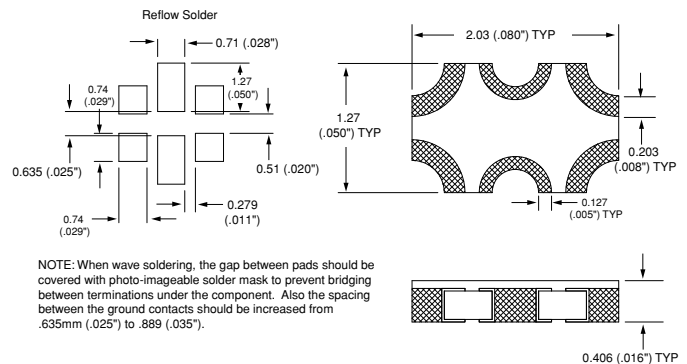

PulseGuard® Suppressors

Surface Mount Polymeric ESD Suppressors

PGB Series 0805 ESD Suppressor

Electrical Characteristics

ESD Capability

IEC 61000-4-2 Direct Discharge	8kV
IEC 61000-4-2 Air Discharge	15kV
Trigger Voltage ¹	1,000 V, typical
Clamping Voltage ¹	150V, typical
Rated Voltage	24VDC, max
Capacitance ²	0.055 pF
Response Time ¹	< 1ns
Leakage Current ³	< 1nA
ESD Pulse Withstand ⁴	1,000 pulses, minimum

Notes:

1. Trigger and clamping voltage measured per IEC 61000-4-2, 8kV direct discharge method.
2. Capacitance measured at 1MHz.
3. Leakage current measured at 6VDC.
4. Pulse Withstand- some shifting in characteristics may occur when tested over multiple pulses at a very rapid rate.

Environmental Specifications

Operating Temperature: -65°C to +125°C.

Moisture Resistance, steady state: MIL-STD-883, method 1004.7, 85% RH, 85°C, 1000hrs.

Thermal Shock: MIL-STD-202, Method 107G, -65°C to 125°C, 30 min cycle, 10 cycles.

Vibration: MIL-STD-202F, Method 201A, (10 to 55 to 10Hz, 1 min. cycle, 2grs each in X-Y-Z)

Physical Specifications

Materials:

Body: Glass Epoxy

Terminations: Copper/Nickel/Tin/Lead

Solderability: MIL-STD-202, Method 208 (95% coverage)

Soldering Parameters:

Wave Solder – 260°C, 10 seconds maximum.

Reflow Solder – 260°C, 30 seconds maximum.

Packaging Specifications

8mm Tape and Reel per EIA-RS481-1 (IEC 286, part3); 1,000 pieces per reel, add packaging suffix, MR; 5,000 per reel, add packaging suffix NR.

Capacitance vs. Frequency

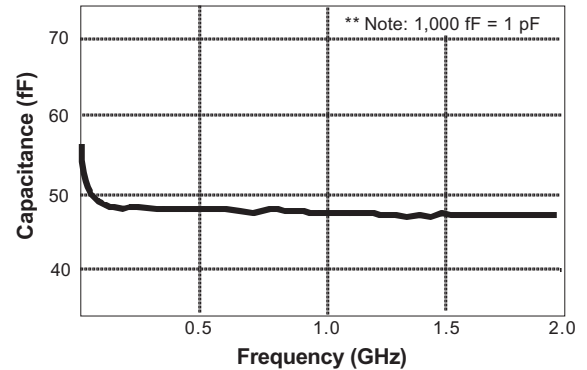

Carrier Tape Specifications

Parts are delivered on 7" (178mm) reel, paper carrier tape

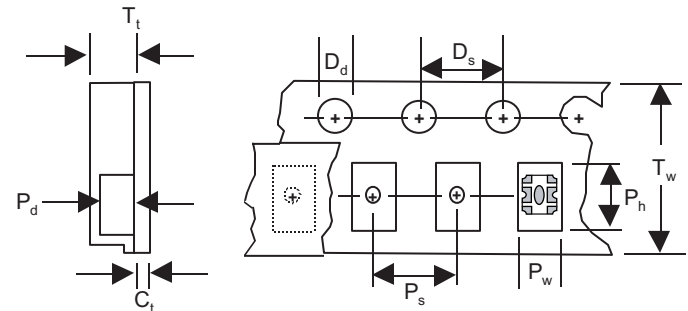

DESCRIPTION	MEASUREMENT (MM)
C _t - Cover tape thickness	0.06
D _d - Drive hole diameter	1.50
D _s - Drive hole spacing	4.00
P _d - Pocket depth	0.58
P _h - Pocket height	2.21
P _s - Pocket spacing	4.00
P _w - Pocket width	1.45
T _t - Carrier tape thickness	0.65
T _w - Carrier tape width	8.00