

Description

Silicon rectifiers that are excellent for DC phase control applications with motor loads.

Isolated mounting tab allows for use in circuits with common anode or common cathode connections.

Features & Benefits

- RoHS Compliant
- Glass – passivated junctions
- Voltage capability up to 1000 V
- Surge capability up to 350 A

Applications

Typical applications are AC to DC solid-state switches for industrial power tools, exercise equipment, white goods, and commercial appliances.

Internally constructed isolated package is offered for ease of heat sinking with highest isolation voltage.

Agency Approval

Agency	Agency File Number
	L Package : E71639

Schematic Symbol

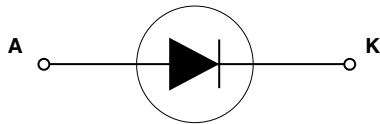

Main Features

Symbol	Value	Unit
$I_{T(RMS)}$	15 / 20 / 25	A
V_{RRM}	400 to 1000	V

Absolute Maximum Ratings

Symbol	Parameter	Test Conditions	Value			Unit
			Dxx15L	Dxx20L	Dxx25L	
$I_{F(RMS)}$	RMS forward current	Dxx15L: $T_C = 85^\circ\text{C}$	15	20	25	A
$I_{F(AV)}$	Average forward current	Dxx20L/Dxx25L: $T_C = 80^\circ\text{C}$	9.5	12.7	15.9	A
I_{FSM}	Peak non-repetitive surge current	single half cycle; $f = 50\text{Hz}$; T_J (initial) = 25°C	188	255	300	A
		single half cycle; $f = 60\text{Hz}$; T_J (initial) = 25°C	225	300	350	
I^2t	I^2t Value for fusing	$t_p = 8.3 \text{ ms}$	210	374	508	A^2s
T_{stg}	Storage temperature range		-40 to 150			$^\circ\text{C}$
T_J	Operating junction temperature range		-40 to 125			$^\circ\text{C}$

Note: xx = voltage

Electrical Characteristics (T_J = 25°C, unless otherwise specified)

Symbol	Parameter	Test Conditions	Value	Unit
t _{rr}	Reverse-recovery Time	I _F =0.9A, I _R =1.5A	TYP. 4	μs

Static Characteristics

Symbol	Parameter	Test Conditions	Value	Unit		
V _{FM}		15A Device I _T = 30A; t _p = 380μs	MAX.	1.6	V	
		20A Device I _T = 40A; t _p = 380μs				
		25A Device I _T = 50A; t _p = 380μs				
I _{RM}	V _{RRM}	T _J = 25°C	MAX.	400-600V	10	μA
				800-1000V	20	
		T _J = 100°C		400-800V	500	
				1000V	3000	
		T _J = 125°C		400-800V	1000	

Thermal Resistances

Symbol	Parameter	Value	Unit
R _{θ(J-C)}	Junction to case (AC)	Dxx15L	2.85
		Dxx20L	2.55
		Dxx25L	2.50

Note: xx = voltage

Figure 1: On-State Current vs. On-State Voltage (Typical)

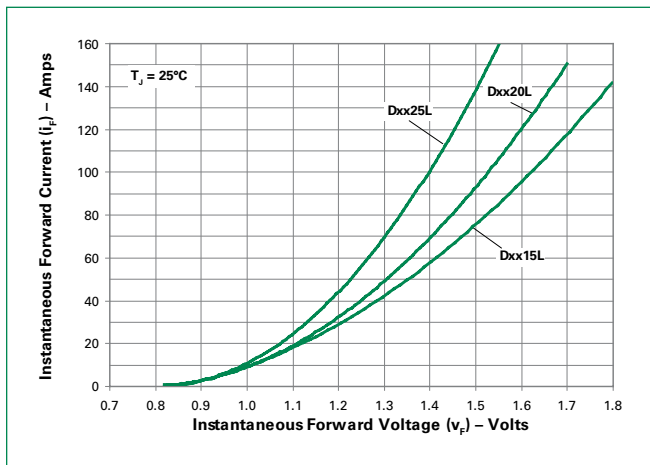

Figure 2: Power Dissipation vs. RMS On-State Current (Typical)

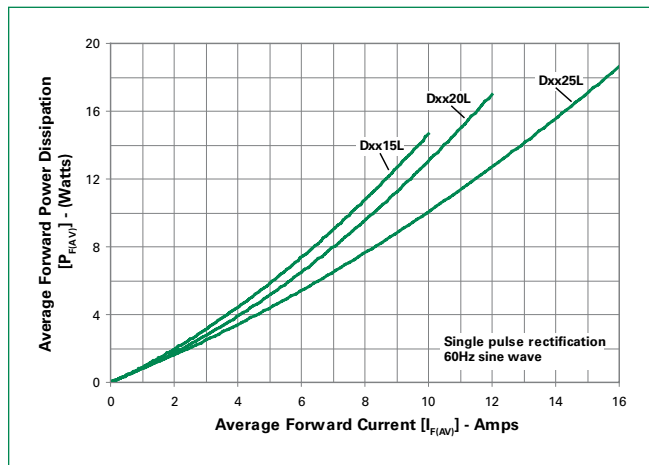
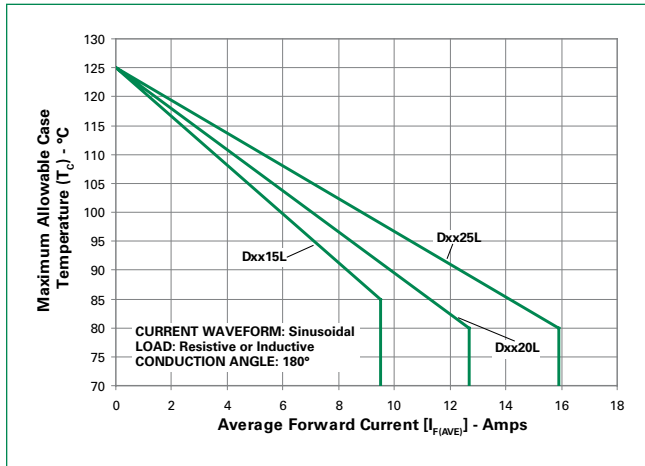
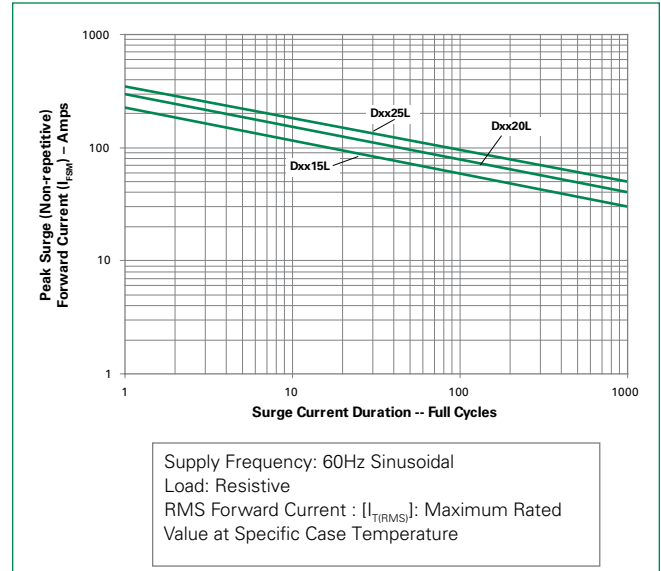

Figure 3: Maximum Allowable Case Temperature vs. Average On-State Current



Note: xx = voltage

Figure 4: Surge Peak On-State Current vs. Number of Cycles



Soldering Parameters

Reflow Condition	Pb – Free assembly	
Pre Heat	- Temperature Min ($T_{s(min)}$)	150°C
	- Temperature Max ($T_{s(max)}$)	200°C
	- Time (min to max) (t_s)	60 – 180 secs
Average ramp up rate (Liquidus Temp (T_L) to peak)	5°C/second max	
$T_{S(max)}$ to T_L - Ramp-up Rate	5°C/second max	
Reflow	- Temperature (T_L) (Liquidus)	217°C
	- Temperature (t_L)	60 – 150 seconds
Peak Temperature (T_p)	260°C ± 0.5	
Time within 5°C of actual peak Temperature (t_p)	20 – 40 seconds	
Ramp-down Rate	5°C/second max	
Time 25°C to peak Temperature (T_p)	8 minutes Max.	
Do not exceed	280°C	

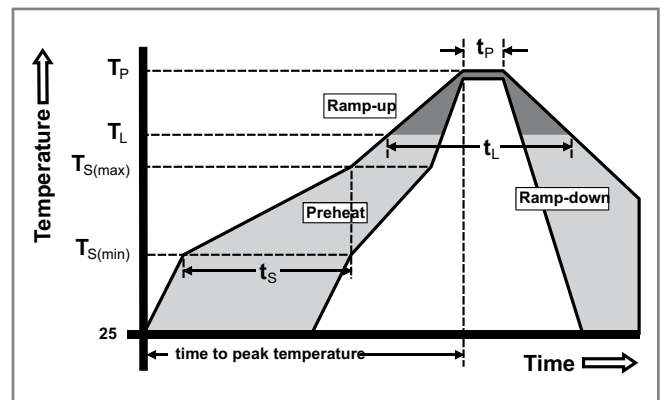

Physical Specifications

Terminal Finish	100% Matte Tin Plated
Body Material	UL recognized epoxy meeting flammability classification 94V-0
Lead Material	Copper Alloy

Design Considerations

Careful selection of the correct device for the application's operating parameters and environment will go a long way toward extending the operating life of the rectifier. Good design practice should limit the maximum continuous current through the main terminals to 75% of the device rating. Other ways to ensure long life for a power discrete semiconductor are proper heat sinking and selection of voltage ratings for worst case conditions. Overheating, overvoltage (including dv/dt), and surge currents are the main killers of semiconductors. Correct mounting, soldering, and forming of the leads also help protect against component damage.

Environmental Specifications

Test	Specifications and Conditions
High Temperature Voltage Blocking	MIL-STD-750: Method 1040, Condition A Rated V_{RRM} , 125°C, 1008 hours
Temperature Cycling	MIL-STD-750: Method 1051 -40°C to 150°C, 15-minute dwell, 100 cycles
Biased Temperature & Humidity	EIA/JEDEC: JESD22-A101 320VDC, 85°C, 85%RH, 1008 hours
High Temp Storage	MIL-STD-750: Method 1031 150°C, 1008 hours
Low-Temp Storage	1008 hours; -40°C
Thermal Shock	MIL-STD-750: Method 1056 0°C to 100°C, 5-minute dwell, 10-second transfer, 10 cycles
Autoclave (Pressure Cooker Test)	EIA/JEDEC: JESD22-A102 121°C, 100%RH, 2atm, 168 hours
Resistance to Solder Heat	MIL-STD-750: Method 2031 260°C, 10 seconds
Solderability	ANSI/J-STD-002, Category 3, Test A
Lead Bend	MIL-STD-750: Method 2036, Condition E

Dimensions — TO-220AB (L-Package) — Isolated Mounting Tab

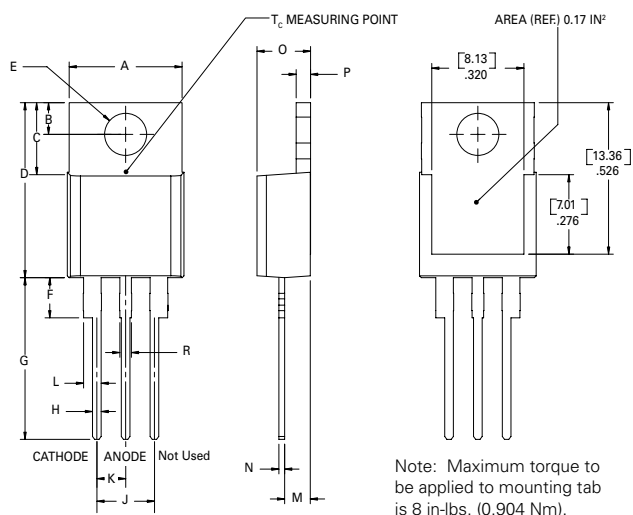

Dimension	Inches		Millimeters	
	Min	Max	Min	Max
A	0.380	0.420	9.65	10.67
B	0.105	0.115	2.67	2.92
C	0.230	0.250	5.84	6.35
D	0.590	0.620	14.99	15.75
E	0.142	0.147	3.61	3.73
F	0.110	0.130	2.79	3.30
G	0.540	0.575	13.72	14.61
H	0.025	0.035	0.64	0.89
J	0.195	0.205	4.95	5.21
K	0.095	0.105	2.41	2.67
L	0.060	0.075	1.52	1.91
M	0.085	0.095	2.16	2.41
N	0.018	0.024	0.46	0.61
O	0.178	0.188	4.52	4.78
P	0.045	0.060	1.14	1.52
R	0.038	0.048	0.97	1.22

Product Selector

Part Number	Voltage				Type	Package
	400V	600V	800V	1000V		
Dxx15L	X	X	X	X	Rectifier	TO-220L
Dxx20L	X	X	X	X	Rectifier	TO-220L
Dxx25L	X	X	X	X	Rectifier	TO-220L

Note: xx = Voltage

Packing Options

Part Number	Marking	Weight	Packing Mode	Base Quantity
Dxx15L	Dxx15L	2.2 g	Bulk	500
Dxx15LTP	Dxx15L	2.2 g	Tube	500 (50 per tube)
Dxx20L	Dxx20L	2.2 g	Bulk	500
Dxx20LTP	Dxx20L	2.2 g	Tube	500 (50 per tube)
Dxx25L	Dxx25L	2.2 g	Bulk	500
Dxx25LTP	Dxx25L	2.2 g	Tube	500 (50 per tube)

Note: xx = Voltage

Part Numbering System

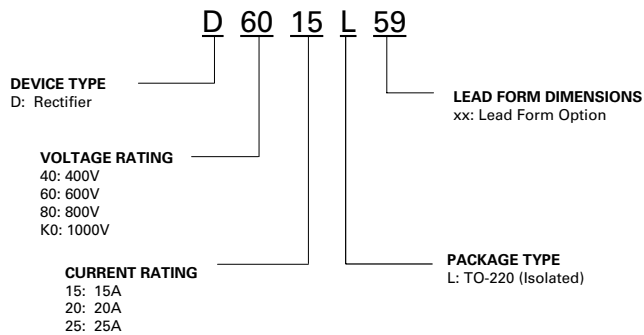

Part Marking System

TO-220AB (L Package)

