



EMC filters

4-line filters
for installations and systems
Rated current 6 to 125 A

Series/Type: B84131
Date: January 2006

Power line filters for 3-phase systems
Rated voltage 440/250 V AC, 50/60 Hz
Rated current 6 to 125 A

Construction

- 4-line filter
- Metal case

Features

- High insertion loss
- Compact, cost-optimized design
- Easy to install
- ENEC10, UL and CSA approval 



Applications

- Power supplies for
 - data systems, telecom systems
 - medical equipment, industrial installations
 - copiers

Terminals

- Tab connectors 6.3 × 0.8 mm
- Screw terminals

Marking

Marking on component:

Manufacturer's logo, ordering code,
 rated voltage, rated current, rated temperature,
 climatic category, date code

Minimum marking on packaging:

Manufacturer's logo, ordering code



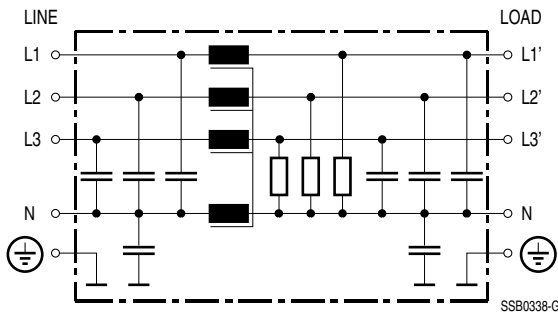

Circuit diagram



Technical data and measuring conditions

| | |
|---------------------------------|---|
| Rated voltage V_R | 440/250 V AC, 50/60 Hz |
| Rated current I_R | Referred to 40 °C ambient temperature |
| Test voltage V_{test} | 1770 V DC, 2 s (line/line) 2700 V DC, 2 s (lines/case) |
| Leakage current I_{leak} | At 400 V AC, 50 Hz |
| Climatic category (IEC 60068-1) | 25/085/21 (-25 °C/+85 °C/21 days damp heat test) |
| Approvals | EN 133200, UL 1283, CSA C22.2 No.8 |

Characteristics and ordering codes

| V_R AC V | I_R A | I_{leak} mA | Approx. weight kg | Ordering code | Approvals | | |
|------------------|------------|------------------|-------------------------|-----------------|---|---|---|
| | | | | |  |  |  |
| 440/250 | 6 | < 3.5 | 0.8 | B84131A0006A001 | × | – | – |
| | 16 | < 3.5 | 1.5 | B84131M0003A116 | × | × | × |
| | 25 | < 3.5 | 2.3 | B84131M0001G125 | × | × |  |
| | 35 | < 3.5 | 2.3 | B84131M0001G135 | × | × | × |
| | 35 | < 3.5 | 2.3 | B84131M0001H135 | – | × | × |
| | 50 | < 3.5 | 4.5 | B84131M0002G150 | × | × | × |
| | 63 | < 3.5 | 4.5 | B84131M0002G163 | × | × | × |
| | 80 | < 3.5 | 12.5 | B84131M0004G180 | × | – | – |
| | 125 | < 3.5 | 12.5 | B84131M0004G225 | × | – | – |

× = approval granted

Dimensional drawings

B84131A0006A001 (6 A)

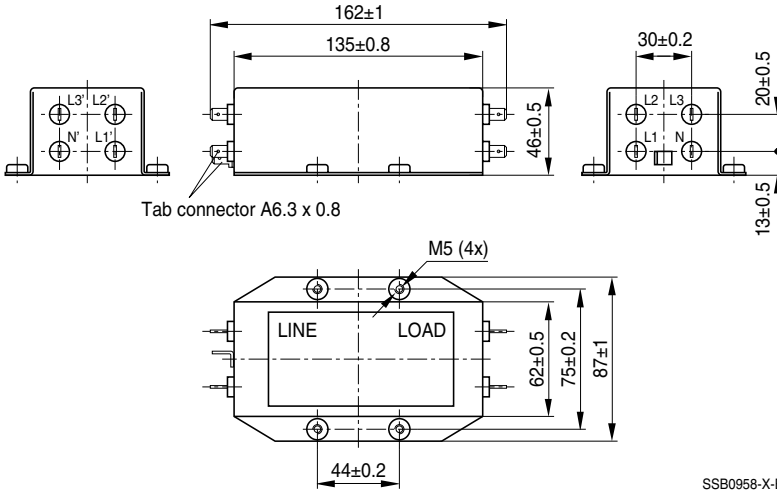

B84131M0003A116 (16 A)

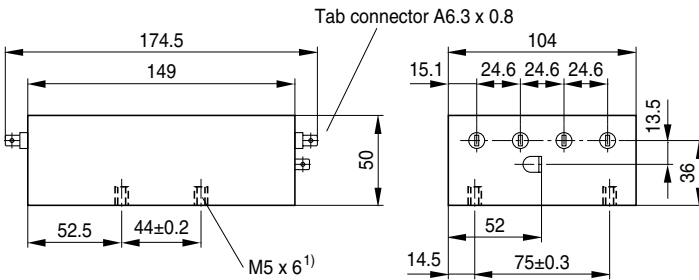

1) Also suitable for screws with 10-32 UNF thread

B84131M0001G125, B84131M0001G135/H135 (25 A, 35 A)

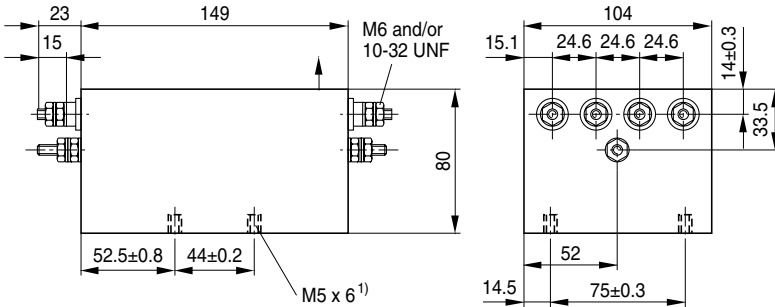

1) Also suitable for screws with 10-32 UNF thread

SSB0321-L-E

| Type | I _R | Screw thread | Tightening torque |
|-------------|----------------|--------------|-------------------|
| B84131M0001 | A | | Nm |
| G125 | 25 | M6 | 3 |
| G135 | 35 | M6 | 3 |
| H135 | 35 | 10-32 UNF | 2 |

B84131M0002G150, B84131M0002G163 (50 A, 63 A)

Screw thread M6

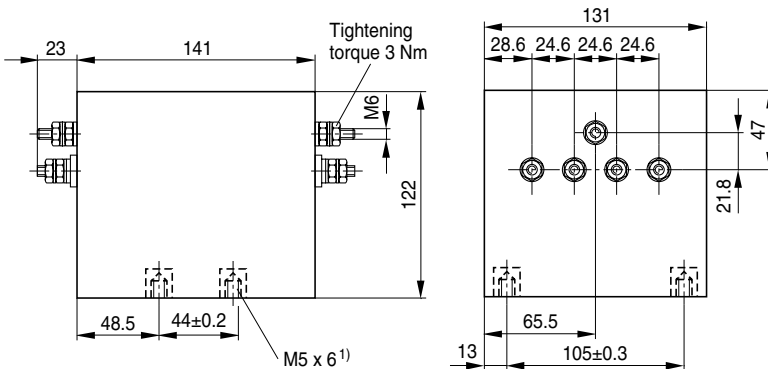

1) Also suitable for screws with 10-32 UNF thread

SSB0322-U-E

B84131M0004G180, B84131M0004G225 (80 A, 125 A)

Screw thread M10

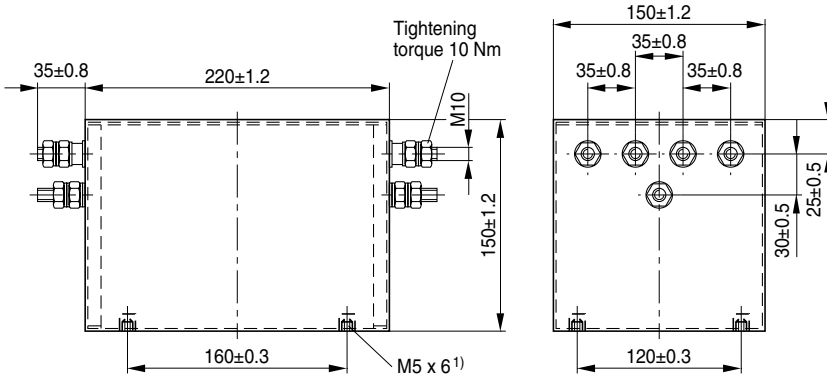

1) Also suitable for screws with 10-32 UNF thread

SSB0544-3-E

Insertion loss (typical values at $Z = 50 \Omega$)

- unsymmetrical, adjacent branches terminated
- - - - - common mode, all branches in parallel (asymmetrical)
- - - - - differential mode (symmetrical)

Filters for 6 A

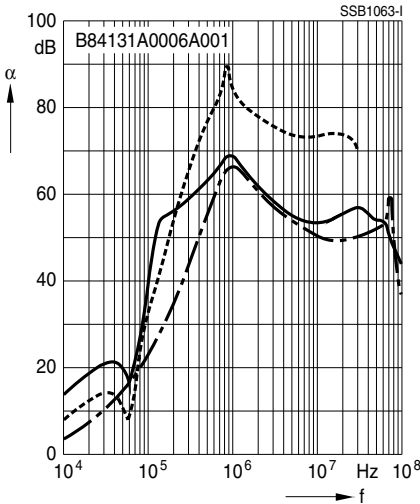

Filters for 16 A

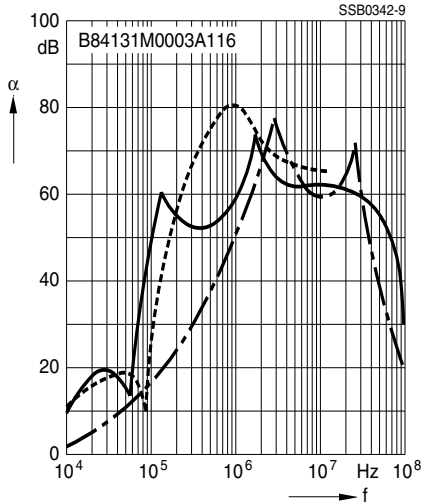

Filters for 25 A

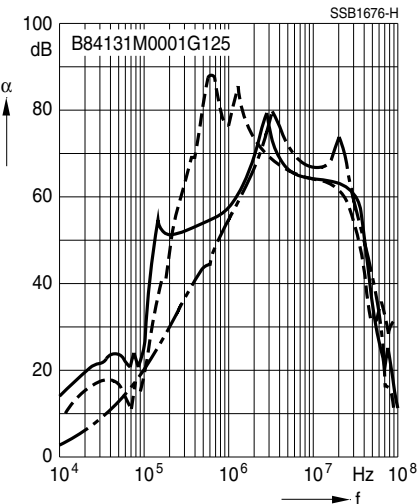

Filters for 35 A

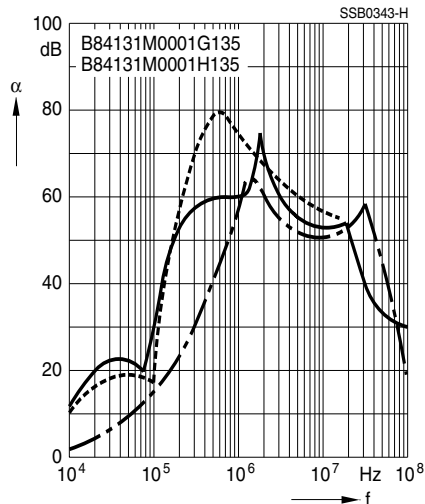

Insertion loss (typical values at $Z = 50 \Omega$)

- unsymmetrical, adjacent branches terminated
- - - - - common mode, all branches in parallel (asymmetrical)
- - - - - differential mode (symmetrical)

Filters for 50 A

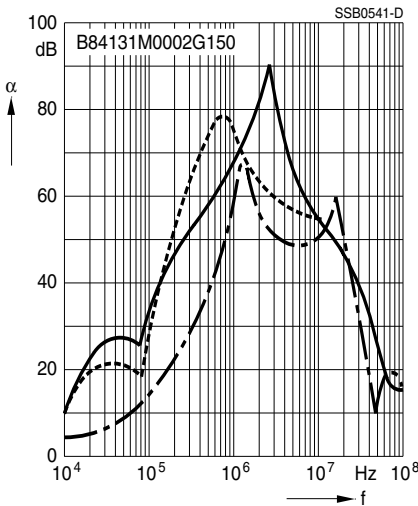

Filters for 63 A

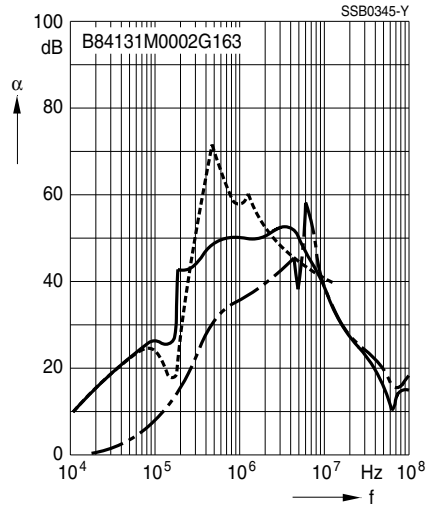

Filters for 80 A



Filters for 125 A

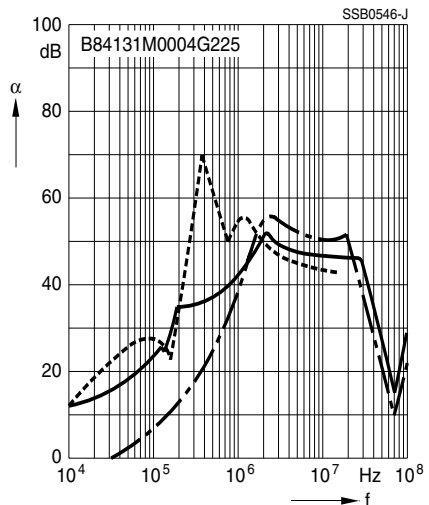

Important information

Please read all safety and warning notes carefully before installing the EMC filter and putting it into operation (see ). The same applies to the warning signs on the filter. Please ensure that the signs are not removed nor their legibility impaired by external influences.

Death, serious bodily injury and substantial material damage to equipment may occur if the appropriate safety measures are not carried out or the warnings in the text are not observed.

Using according to the terms

The EMC filters may be used only for their intended application within the specified values in low-voltage networks in compliance with the instructions given in the data sheets and the data book. The conditions at the place of application must comply with all specifications for the filter used.

Warnings

- It shall be ensured that only qualified persons (electricity specialists) are engaged on work such as planning, assembly, installation, operation, repair and maintenance. They must be provided with the corresponding documentation.
- Danger of electric shock. EMC filters contain components that store an electric charge. Dangerous voltages can continue to exist at the filter terminals for longer than five minutes even after the power has been switched off.
- The protective earth connections shall be the first to be made when the EMC filter is installed and the last to be disconnected. Depending on the magnitude of the leakage currents, the particular specifications for making the protective-earth connection must be observed.
- Impermissible overloading of the EMC filter, such as impermissible voltages at higher frequencies that may cause resonances etc. can lead to destruction of the filter housing.
- EMC filters must be protected in the application against impermissible exceeding of the rated currents by suitable overcurrent protective.

The following applies to all products named in this publication:

1. Some parts of this publication contain **statements about the suitability of our products for certain areas of application**. These statements are based on our knowledge of typical requirements that are often placed on our products in the areas of application concerned. We nevertheless expressly point out **that such statements cannot be regarded as binding statements about the suitability of our products for a particular customer application**. As a rule, EPCOS is either unfamiliar with individual customer applications or less familiar with them than the customers themselves. For these reasons, it is always ultimately incumbent on the customer to check and decide whether an EPCOS product with the properties described in the product specification is suitable for use in a particular customer application.
2. We also point out that **in individual cases, a malfunction of passive electronic components or failure before the end of their usual service life cannot be completely ruled out in the current state of the art, even if they are operated as specified**. In customer applications requiring a very high level of operational safety and especially in customer applications in which the malfunction or failure of a passive electronic component could endanger human life or health (e.g. in accident prevention or life-saving systems), it must therefore be ensured by means of suitable design of the customer application or other action taken by the customer (e.g. installation of protective circuitry or redundancy) that no injury or damage is sustained by third parties in the event of malfunction or failure of a passive electronic component.
3. **The warnings, cautions and product-specific notes must be observed.**
4. In order to satisfy certain technical requirements, **some of the products described in this publication may contain substances subject to restrictions in certain jurisdictions (e.g. because they are classed as “hazardous”)**. Useful information on this will be found in our Material Data Sheets on the Internet (www.epcos.com/material). Should you have any more detailed questions, please contact our sales offices.
5. We constantly strive to improve our products. Consequently, **the products described in this publication may change from time to time**. The same is true of the corresponding product specifications. Please check therefore to what extent product descriptions and specifications contained in this publication are still applicable before or when you place an order.
We also **reserve the right to discontinue production and delivery of products**. Consequently, we cannot guarantee that all products named in this publication will always be available.
6. Unless otherwise agreed in individual contracts, **all orders are subject to the current version of the “General Terms of Delivery for Products and Services in the Electrical Industry” published by the German Electrical and Electronics Industry Association (ZVEI)**.
7. The trade names EPCOS, EPCOS-Jones, Baoke, CeraDiode, CSSP, MLSC, PhaseCap, PhaseMod, SIFI, SIKOREL, SilverCap, SIMID, SIOV, SIP5D, SIP5K, UltraCap, WindCap are **trademarks registered or pending** in Europe and in other countries. Further information will be found on the Internet at www.epcos.com/trademarks.