

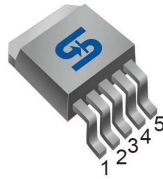

TO-220-5L



TO-263-5L
(D²PAK)



Pin Definition:

1. Input
2. SW Output
3. Ground
4. Feedback
5. Enable

General Description

The TS2596 Series are step-down switching regulators with all required active functions. It is capable of driving 3A load with excellent line and load regulations. These devices are available in fixed output voltages of 3.3V, 5V, and an adjustable output version.

The TS2596 series operates at a switching frequency of 150kHz thus allowing smaller sized filter components than what would be needed with lower frequency switching regulators. It substantially not only reduces the area of board size but also the size of heat sink, and in some cases no heat sink is required. The ±4% tolerance on output voltage within specified input voltages and output load conditions is guaranteed. Also, the oscillator frequency accuracy is within ±10%. External shutdown is included. Featuring 100µA (typical) standby current. The output switch includes cycle-by-cycle current limiting, as well as thermal shutdown for full protection under fault conditions.

Features

- Output Voltage: 3.3V, 5V & Adjustable version
- Adjustable Output Voltage Range 1.23V~38.5V
- 150KHz fixed switching frequency
- Voltage Mode Non-synchronous PWM control
- Thermal Shutdown and Current Limit Protection
- ON/OFF Shutdown Control Input
- High Efficiency
- Short Circuit Protect (SCP)
- Operating Voltage Can be up to 40V
- Output Load Current 3A
- Low Power Standby Mode
- Built-in switching transistor on chip

Ordering Information

Part No.	Package	Packing
TS2596CZ5xx C0	TO-220-5L	50pcs / Tube
TS2596CM5xx RN	TO-263-5L	800pcs / 13" Reel

Note: Where **xx** denotes voltage option, available are

50= 5.0V

33= 3.3V

Leave blank for adjustable version

Application

- Simple High-efficiency Step down Regulator
- On-Card Switching Regulators
- Positive to Negative Converter

Absolute Maximum Rating

Parameter	Symbol	Limit	Unit
Maximum Supply Voltage	V _{CC}	+45	V
Recommend Operating Supply Voltage	V _{OP}	+4.5 to +40	V
SW, EN Pin Input Voltage	V _{SW} , V _{EN}	-0.3 to +40	V
Feedback Pin Voltage	V _{FB}	-0.3 to +12	V
Power Dissipation	P _D	Internally Limited	W
Output Voltage to Ground	V _{OUT}	-1	V
Storage Temperature Range	T _{ST}	-65 to +150	°C
Operating Temperature Range	T _{OP}	-40 to +125	°C
ESD Susceptibility (HBM)		2	kV

Thermal Information

Parameter		Symbol	Maximum	Unit
Thermal Resistance* (Junction to Case)	TO-220-5L	Θ_{JC}	2	°C/W
	TO-263-5L		2	
Thermal Resistance* (Junction to Ambient)	TO-220-5L	Θ_{JA}	50	°C/W
	TO-263-5L		50	

Note: Θ_{JA} is measured with the PCB copper area (need connect to GROUND pins) of approximately 1.5 in² (Multi-layer)

Electrical Specifications (All Output Voltage Version)

($T_a = 25^\circ\text{C}$ unless otherwise noted, $V_{IN}=12\text{V}$ for 3.3V, 5V, Adjustable version. $I_{LOAD}=0.3\text{A}$)

Parameter		Symbol	Test Condition	Min	Typ	Max	Unit
Output Feedback	ADJ	V_{FB}	4.5V ≤ V_{IN} ≤ 40V 0.2A ≤ I_{LOAD} ≤ 3A	1.180	1.23	1.280	V
Efficiency							
Output Feedback	3.3V	V_{FB}	4.75V ≤ V_{IN} ≤ 40V 0.2A ≤ I_{LOAD} ≤ 3A	3.135	3.3V	3.465	V
Efficiency							
Output Feedback	5V	V_{FB}	7V ≤ V_{IN} ≤ 40V 0.2A ≤ I_{LOAD} ≤ 3A	4.75	5	5.25	V
Efficiency							
Feedback Bias Current		I_{FB}	$V_{FB}=1.3\text{V}$ (Adj version only)	--	10	100	nA
Oscillator Frequency		F_{OSC}		127	150	173	KHz
Soft-Start Time		T_{SS}	Rising edge of EN on to I_{CL}	--	3	--	mS
Current Limit		I_{CL}	Peak Current, no outside circuit $V_{FB}=0\text{V}$ force driver on	3.3	--	--	A
Oscillator Frequency of Short Circuit Protect		F_{SCP}	When current limit occurred and $V_{FB}<0.5\text{V}$, $T_a = 25^\circ\text{C}$	110	150	173	KHz
Saturation Voltage		V_{SAT}	$I_{OUT}=3\text{A}$, No outside circuit $V_{FB}=0\text{V}$ force driver on	--	1.15	1.50	V
ON/OFF Pin Logic Input Threshold Voltage		V_{IL}	Low (regulator ON)	--	1.3	0.6	V
		V_{IH}	High (regulator OFF)	2.0		--	
ON/OFF Pin Logic Input Current		I_H	$V_{LOGIC}=2.5\text{V}$ (OFF)	--	5	15	μA
		I_L	$V_{LOGIC}=0.5\text{V}$ (ON)	--	0.02	5	
Maximum Duty Cycle (ON)	DC		$V_{FB}=0\text{V}$ force driver on	--	100	--	%
Maximum Duty Cycle (OFF)			$V_{FB}=12\text{V}$ force driver off	--	0	--	
Quiescent Current		I_Q	$V_{FB}=12\text{V}$ force driver off	--	5	10	mA
Standby Quiescent Current		I_{STBY}	ON/OFF pin=5V	--	80	200	μA
			$V_{IN}=40\text{V}$				
SW Pin Leakage Current	SW pin = 0	I_{SWL}	No outside circuit, $V_{FB}=12\text{V}$ force driver off	--	0.3	2	mA
	SW pin = -1		$V_{IN}=12\text{V}$	--	7.5	30	mA

Block Diagram

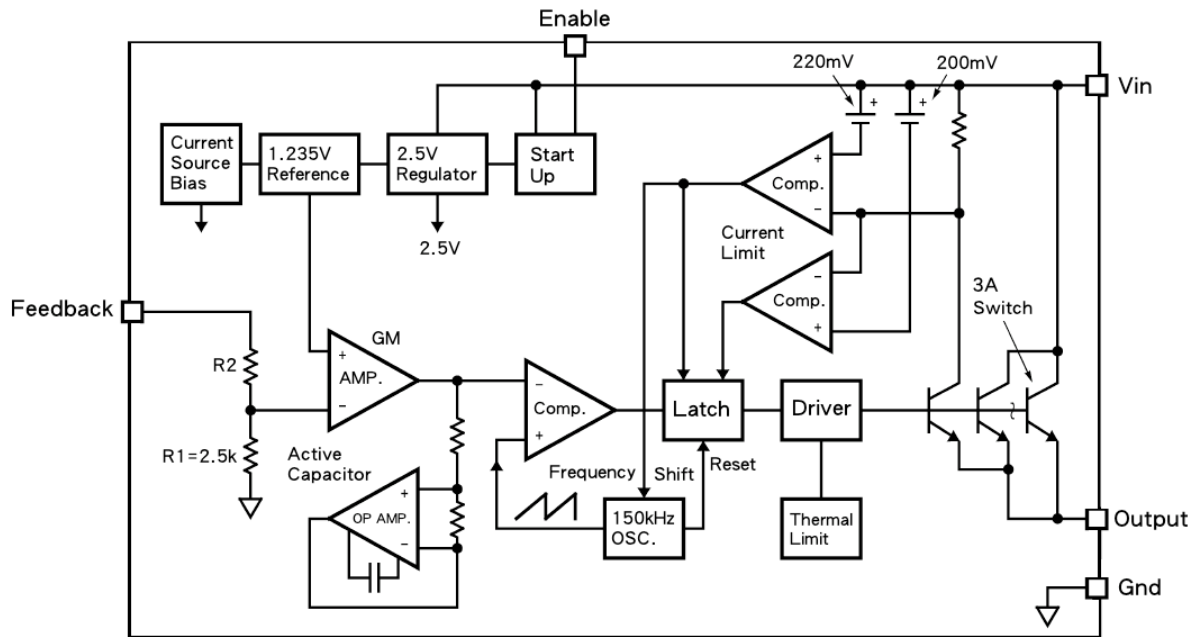

Typical Application Circuit

1. Adjustable Output Voltage Version

VIN=12V

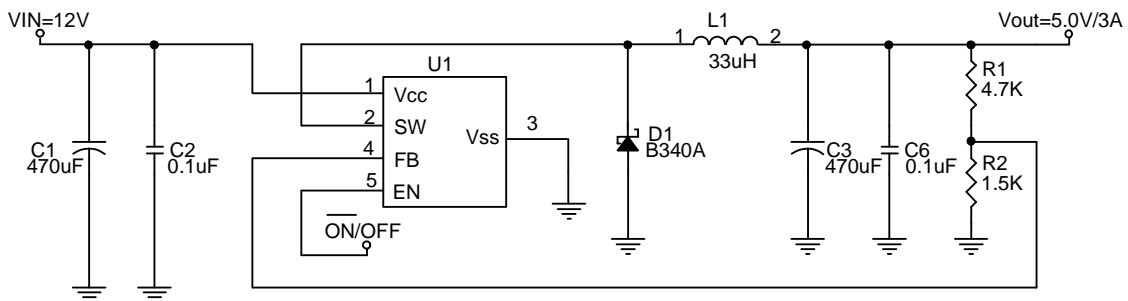

VIN=24V

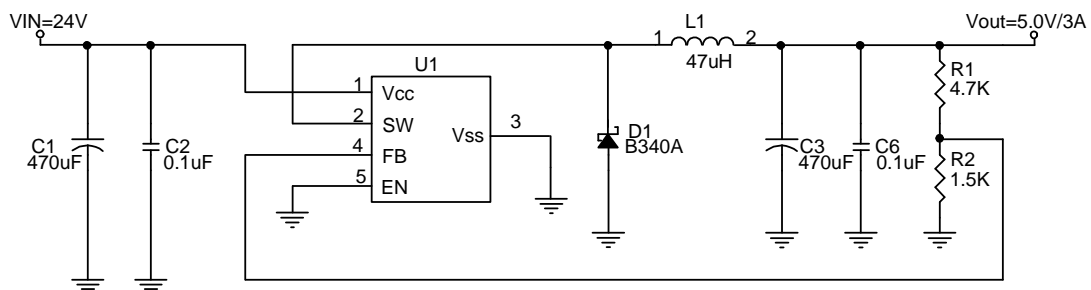

$$V_{OUT} = V_{FB} \times \left(1 + \frac{R1}{R2}\right), V_{FB} = 1.23V, R2 = 0.7K \sim 3K$$

V _{OUT}	R2	R1
5.0V	1.5K	4.7K
3.3V	1.5K	2.5K
2.5V	1.5K	1.5K

Typical Application Circuit (Continue)

2. Fixed Output Voltage Version

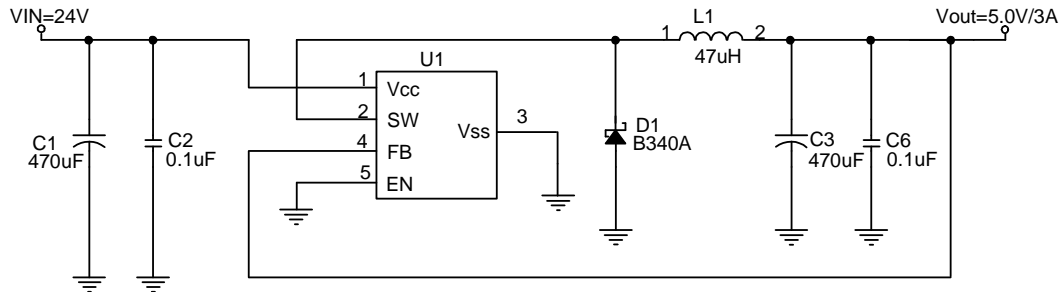

L1 recommend value (I _{OUT} =3A,)				
V _{OUT}	2.5V	3.3V	5V	12V
V _{IN} =12V	33uH	33uH	33~47uH	NA
V _{IN} =24V	33uH	33uH	47uH	68uH

Pin Function Description

Vcc

This is the positive input supply for the IC switching regulator. A suitable input bypass capacitor must be presented at this pin to minimize voltage transients and to supply the switching currents needed by the regulator.

Ground

Circuit ground

SW Output

Internal switch. The voltage at this pin switches between (+Vcc – Vsat) and approximately – 0.5V, with a duty cycle of approximately Vout / Vcc. To minimize coupling to sensitive circuitry, the PC board copper area connected to this pin should be minimized.

Feedback

Sense the regulated output voltage to complete the feedback loop.

Enable

Allows the switching regulator circuit to be shutdown using logic level signals thus dropping the total input supply current to approximately 100uA. Pulling this pin below a threshold voltage of approximately 1.3V turns the regulator on, and pulling this pin above 1.3V (up to a maximum of Vcc) shuts the regulator down. If this shutdown feature is not needed, the EN pin can be wired to the ground pin.

Thermal Considerations

The TS2596 is available in two packages, a TO-220-5L and TO-263-5L.

The TO-220-5L package needs a heat sink under most conditions. The size of the heat sink depends on the input voltage, the output voltage, the load current and the ambient temperature. The TS2596 junction temperature rises above ambient temperature for a 3A load and different input and output voltages. The data for these curves was taken with the TS2596 (TO-220-5L package) operating as a buck switching regulator in an ambient temperature of 25 °C (still air). These temperature rise numbers are all approximate and there are many factors that can affect these temperatures. Higher ambient temperatures require more heat sinking.

The TO-263-5L surface mount package tab is designed to be soldered to the copper on a printed circuit board. The copper and the board are the heat sink for this package and the other heat producing components, such as the catch diode and inductor. The PC board copper area that the package is soldered to should be at least 0.8 in², and ideally should have 2 or more square inches of 2 oz. Additional copper area improves the thermal characteristics,

Pin Function Description (Continue)

Thermal Considerations

but with copper areas greater than approximately 6 in², only small improvements in heat dissipation are realized. If further thermal improvements are needed, double sided, multilayer PC board with large copper areas and/or airflow are recommended.

The TS2596 (TO-263-5L package) junction temperature rise above ambient temperature with a 3A load for various input and output voltages. This data was taken with the circuit operating as a buck switching regulator with all components mounted on a PC board to simulate the junction temperature under actual operating conditions. This curve can be used for a quick check for the approximate junction temperature for various conditions, but be aware that there are many factors that can affect the junction temperature. When load currents higher than 3A are used, double sided or multilayer PC boards with large copper areas and/or airflow might be needed, especially for high ambient temperatures and high output voltages.

For the best thermal performance, wide copper traces and generous amounts of printed circuit board copper should be used in the board layout. (Once exception to this is the output (switch) pin, which should not have large areas of copper.) Large areas of copper provide the best transfer of heat (lower thermal resistance) to the surrounding air, and moving air lowers the thermal resistance even further.

Electrical Characteristics Curve

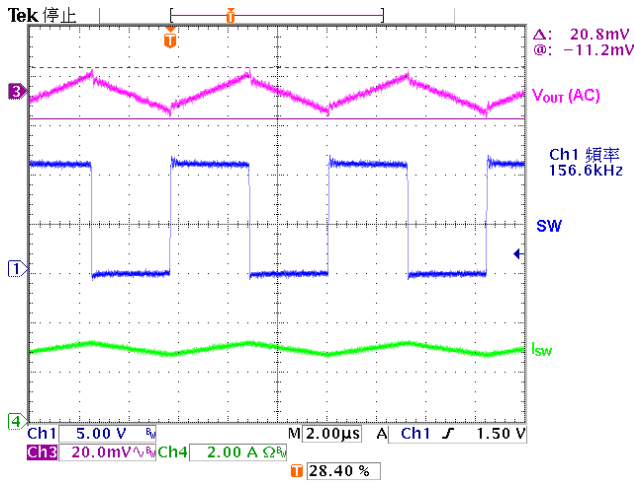

Figure 1. Output Ripple
($V_{IN}=12V$, $V_{OUT}=5V$, $I_O=3A$)

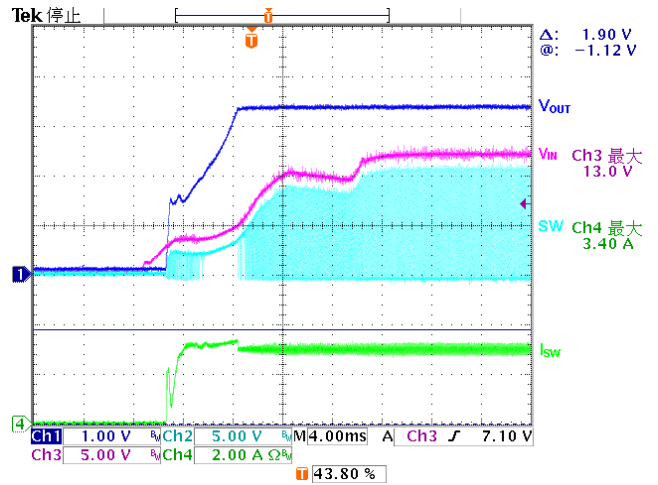

Figure 2. Power On Test Wave
($V_{IN}=12V$, $V_{OUT}=5V$, $I_O=3A$)

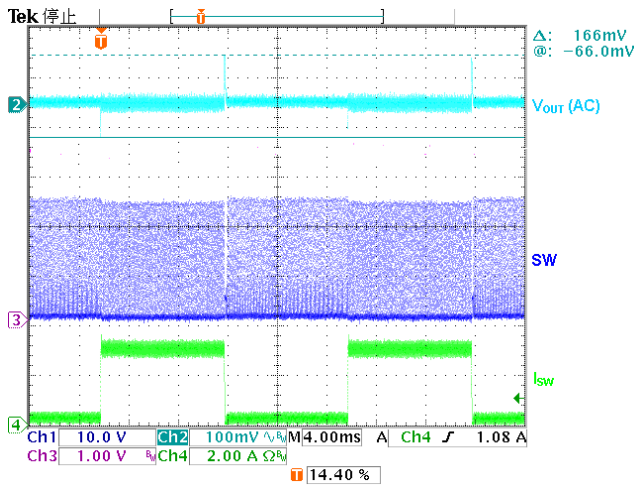

Figure 3. Load Transient Response
($V_{IN}=12V$, $V_{OUT}=5V$, $I_O=0.2\sim 3A$)

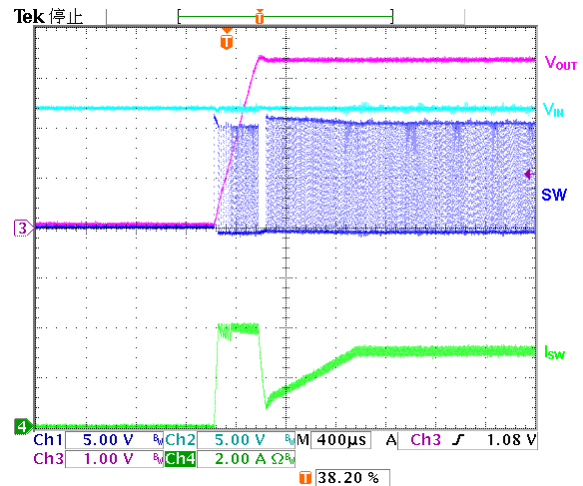

Figure 4. EN On Test Wave
($V_{IN}=12V$, $V_{OUT}=5V$, $I_O=3A$)

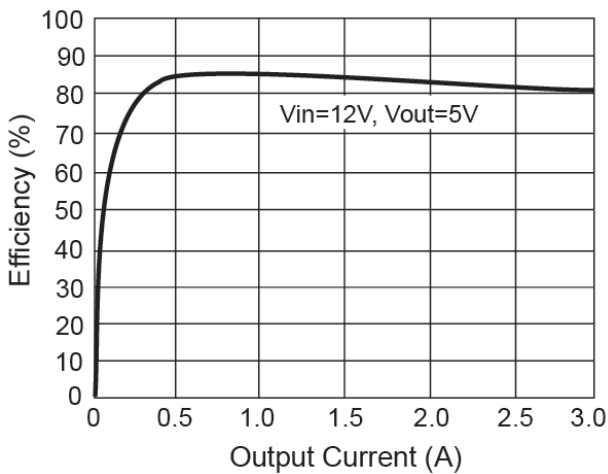

Figure 5. Efficiency

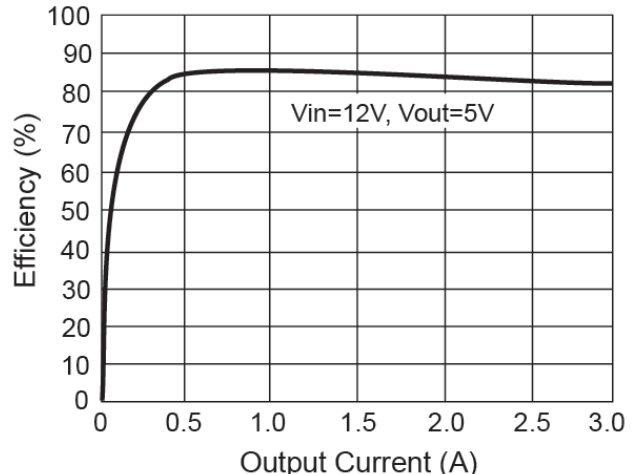
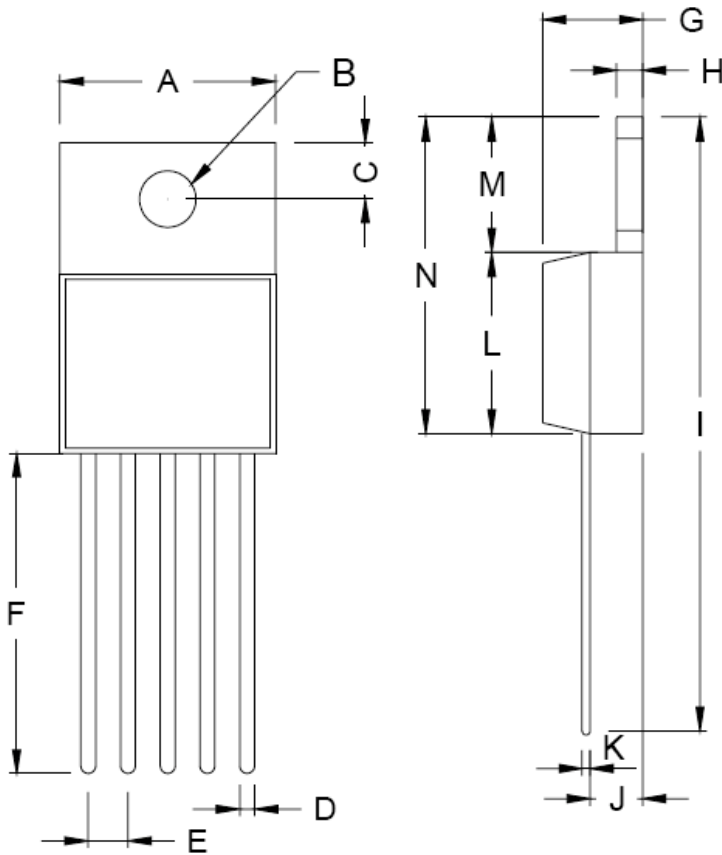

Figure 6. Efficiency

TO-220-5L Mechanical Drawing



TO-220-5L DIMENSION				
DIM	MILLIMETERS		INCHES	
	MIN	MAX	MIN	MAX
A	10.00	10.50	0.394	0.413
B	3.240	4.440	0.128	0.175
C	2.440	2.940	0.096	0.116
D	0.260	1.020	0.010	0.040
E	1.570	1.830	0.062	0.072
F	13.31	14.13	0.524	0.556
G	4.475	5.225	0.176	0.206
H	1.170	1.370	0.046	0.054
I	27.60	29.44	1.087	1.159
J	2.175	2.925	0.086	0.115
K	0.297	0.477	0.012	0.019
L	8.280	8.800	0.326	0.346
M	6.010	6.510	0.237	0.256
N	14.29	15.31	0.563	0.603

Marking Diagram



- Y** = Year Code
- M** = Month Code
(A=Jan, B=Feb, C=Mar, D=Apl, E=May, F=Jun, G=Jul, H=Aug, I=Sep, J=Oct, K=Nov, L=Dec)
- L** = Lot Code
- XXX** = Voltage Code
(3.3=3.3V, 5.0=5V)
= Package Code for Adjustable type
CZ5 = TO-220-5L

TO-263-5L Mechanical Drawing

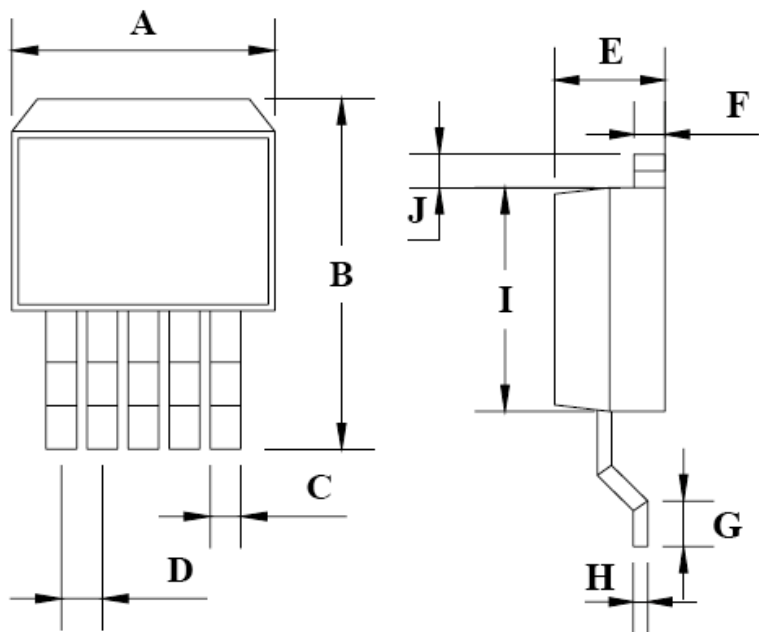

TO-263-5L DIMENSION				
DIM	MILLIMETERS		INCHES	
	MIN	MAX	MIN	MAX
A	10.220	10.260	0.402	0.404
B	14.600	15.870	0.575	0.625
C	0.750	0.770	0.030	0.030
D	1.573	1.827	0.062	0.072
E	4.560	4.570	0.179	0.180
F	1.240	1.270	0.049	0.050
G	2.280	2.790	0.090	0.110
H	0.280	0.320	0.011	0.013
I	8.240	8.280	0.324	0.326
J	1.540	1.800	0.060	0.071

Marking Diagram

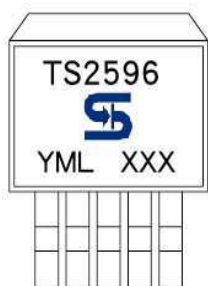

- Y** = Year Code
- M** = Month Code
(**A**=Jan, **B**=Feb, **C**=Mar, **D**=Apr, **E**=May, **F**=Jun, **G**=Jul, **H**=Aug, **I**=Sep, **J**=Oct, **K**=Nov, **L**=Dec)
- L** = Lot Code
- XXX** = Voltage Code
(**3.3**=3.3V, **5.0**=5V)
- = Package Code for Adjustable type
CM5 = TO-263-5L)

Notice

Specifications of the products displayed herein are subject to change without notice. TSC or anyone on its behalf, assumes no responsibility or liability for any errors or inaccuracies.

Information contained herein is intended to provide a product description only. No license, express or implied, to any intellectual property rights is granted by this document. Except as provided in TSC's terms and conditions of sale for such products, TSC assumes no liability whatsoever, and disclaims any express or implied warranty, relating to sale and/or use of TSC products including liability or warranties relating to fitness for a particular purpose, merchantability, or infringement of any patent, copyright, or other intellectual property right.

The products shown herein are not designed for use in medical, life-saving, or life-sustaining applications. Customers using or selling these products for use in such applications do so at their own risk and agree to fully indemnify TSC for any damages resulting from such improper use or sale.