

### Features

- ✧ Low power loss, high efficiency
- ✧ High current capability, low VF
- ✧ High reliability
- ✧ High surge current capability
- ✧ Epitaxial construction
- ✧ Guard-ring for transient protection
- ✧ For use in low voltage, high frequency inverter, free wheeling, and polarity protection application
- ✧ Green compound with suffix "G" on packing code & prefix "G" on datecode



### Mechanical Data

- ✧ Case: TO-220AC molded plastic
- ✧ Epoxy: UL 94V-0 rate flame retardant
- ✧ Terminals: Pure tin plated, lead free, solderable per MIL-STD-202, Method 208 guaranteed
- ✧ Polarity: As marked
- ✧ High temperature soldering guaranteed: 260°C/10 seconds/.25", (6.35mm) from case
- ✧ Weight: 1.87 gram

### Ordering Information(example)

Part No.	Package	Packing	Packing code	Green Compound Packing code
SRA1620	TO-220AC	50 / TUBE	D0	D0G

### Maximum Ratings and Electrical Characteristics

Rating at 25 °C ambient temperature unless otherwise specified.

Single phase, half wave, 60 Hz, resistive or inductive load.

For capacitive load, derate current by 20%

Type Number	Symbol	SRA 1620	SRA 1630	SRA 1640	SRA 1650	SRA 1660	SRA 1690	SRA 16100	Unit
Maximum Repetitive Peak Reverse Voltage	$V_{RRM}$	20	30	40	50	60	90	100	V
Maximum RMS Voltage	$V_{RMS}$	14	21	28	35	42	63	70	V
Maximum DC Blocking Voltage	$V_{DC}$	20	30	40	50	60	90	100	V
Maximum Average Forward Rectified Current	$I_{F(AV)}$	16							A
Peak Forward Surge Current, 8.3 ms Single Half Sine-wave Superimposed on Rated Load (JEDEC method)	$I_{FSM}$	200							A
Maximum Instantaneous Forward Voltage (Note 1) @ 16A	$V_F$	0.55		0.70		0.92		V	
Maximum Reverse Current @ Rated VR $T_A=25^\circ\text{C}$ $T_A=100^\circ\text{C}$ $T_A=125^\circ\text{C}$	$I_R$	0.5					0.1		mA
		15		10		-			
		-					5		
Typical Junction Capacitance (Note 2)	$C_j$	700		550		480		pF	
Typical Thermal Resistance	$R_{\theta JC}$	5							°C/W
Operating Temperature Range	$T_J$	- 65 to + 125			- 65 to + 150				°C
Storage Temperature Range	$T_{STG}$	- 65 to + 150							°C

Note 1 : Pulse Test : 300 usec Pulse Width, 1% Duty Cycle

Note 2 : Measure at 1MHz and Applied Reverse Voltage of 4.0V D.C.

RATINGS AND CHARACTERISTIC CURVES (SRA1620 THRU SRA16100)

FIG. 1 FORWARD CURRENT DERATING CURVE

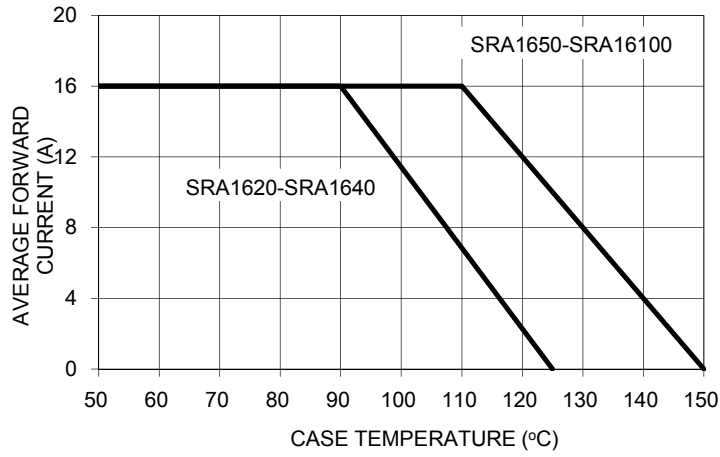

FIG. 2 MAXIMUM NON-REPETITIVE FORWARD SURGE CURRENT

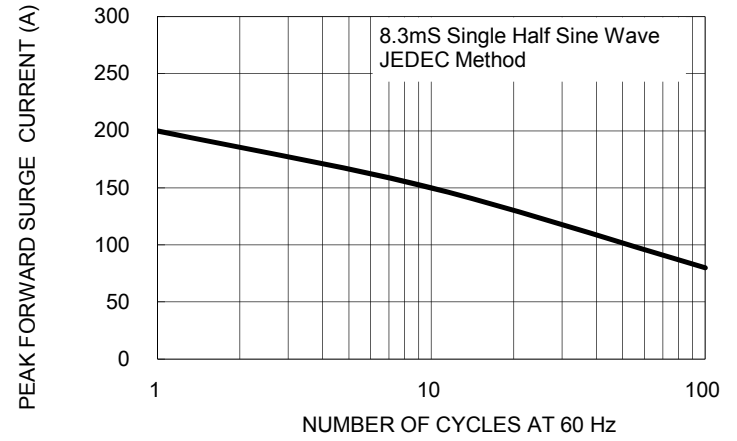

FIG. 3 TYPICAL FORWARD CHARACTERISTICS

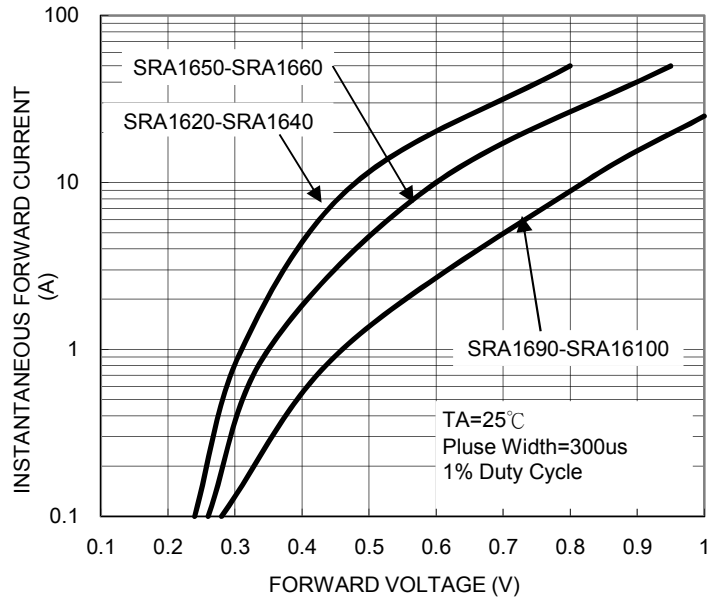

FIG. 4 TYPICAL REVERSE CHARACTERISTICS

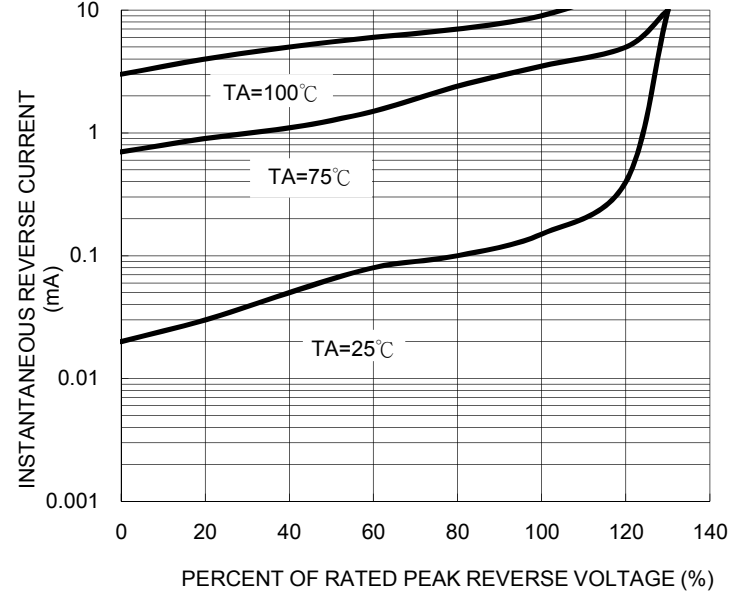

FIG. 5 TYPICAL JUNCTION CAPACITANCE

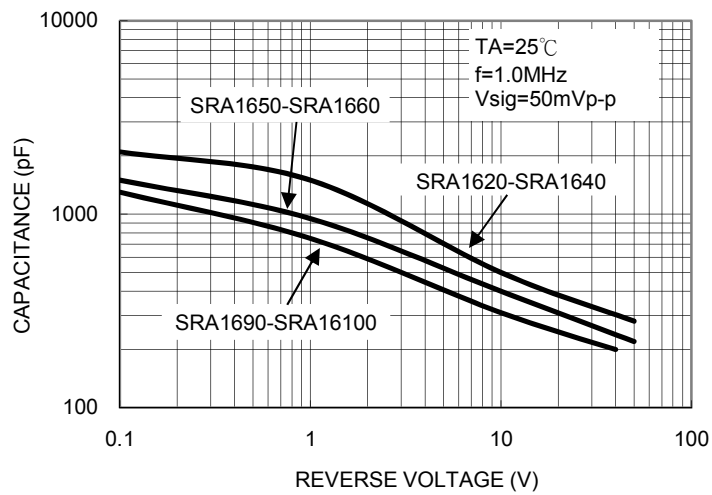
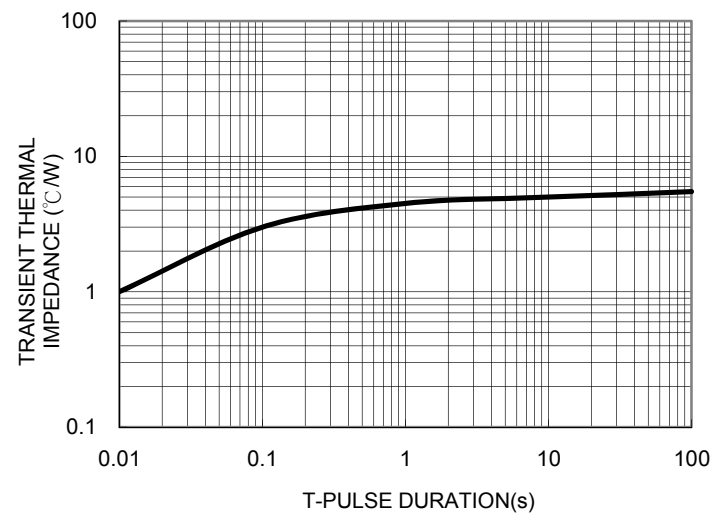

FIG. 6 TYPICAL TRANSIENT THERMAL IMPEDANCE



**Ordering information**

Part No.	Package	BULK Packing	Packing code	Green Compound Packing code
SRA16xx	TO-220AC	50 / TUBE	C0	C0G
	TO-220AC	50 / TUBE	D0	D0G

Note: "xx" is Device Code from "20" thru "100".

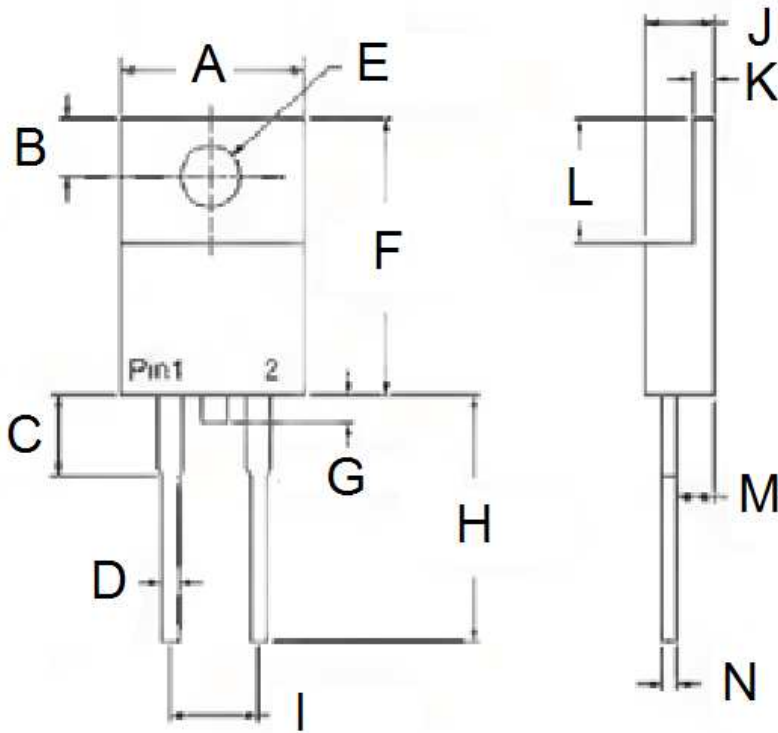
**Dimensions**

DIM.	Unit(mm)		Unit(inch)	
	Min	Max	Min	Max
A	-	10.50	-	0.413
B	2.62	3.44	0.103	0.135
C	2.80	4.20	0.110	0.165
D	0.68	0.94	0.027	0.037
E	3.54	4.00	0.139	0.157
F	14.60	16.00	0.575	0.630
G	-	1.60	-	0.063
H	13.19	14.79	0.519	0.582
I	4.95	5.20	0.195	0.205
J	4.42	4.76	0.174	0.187
K	1.14	1.40	0.045	0.055
L	5.84	6.86	0.230	0.270
M	2.20	2.80	0.087	0.110
N	0.35	0.64	0.014	0.025

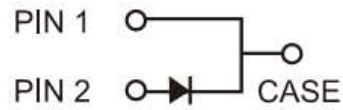
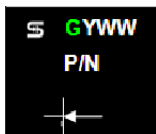
**Marking Diagram**

P/N = Specific Device Code  
 G = Green Compound  
 YWW = Date Code