

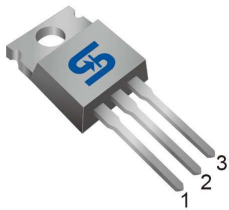

TO-220

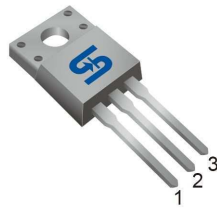

ITO-220



Pin Definition:

1. Gate
2. Drain
3. Source

PRODUCT SUMMARY

V_{DS} (V)	$R_{DS(on)}$ (Ω)	I_D (A)
900	1.4 @ $V_{GS}=10V$	9

General Description

The TSM9N90 N-Channel enhancement mode Power MOSFET is produced by planar stripe DMOS technology. This advanced technology has been especially tailored to minimize on-state resistance, provide superior switching performance, and withstand high energy pulse in the avalanche and commutation mode. These devices are well suited for high efficiency switch mode power supply, electronic lamp ballast based on half bridge.

Features

- Low $R_{DS(ON)}$ 1.4 Ω (Max.)
- Low gate charge typical @ 65nC (Typ.)
- Improve dv/dt capability

Block Diagram

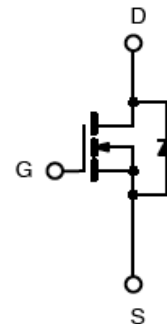

N-Channel MOSFET

Ordering Information

Part No.	Package	Packing
TSM9N90CZ C0	TO-220	50pcs / Tube
TSM9N90CI C0	ITO-220	50pcs / Tube

Absolute Maximum Rating ($T_a = 25^\circ C$ unless otherwise noted)

Parameter	Symbol	TO-220	ITO-220	Unit
Drain-Source Voltage	V_{DS}	900		V
Gate-Source Voltage	V_{GS}	± 30		V
Continuous Drain Current	I_D	$T_c = 25^\circ C$	9	9 *
		$T_c = 100^\circ C$	5.7	5.7 *
Pulsed Drain Current *	I_{DM}	36	36 *	A
Peak Diode Recovery dv/dt (Note 3)	dv/dt	4.5		V
Single Pulse Avalanche Energy (Note 2)	E_{AS}	857		mJ
Avalanche Current (Repetitive) (Note 1)	I_{AR}	9		A
Repetitive Avalanche Energy (Note 1)	E_{AR}	29		mJ
Power Dissipation	P_D	$T_c = 25^\circ C$	290	48
		Derate above 25 $^\circ C$	2.32	0.38
Operating Junction Temperature	T_J	150		$^\circ C$
Storage Temperature Range	T_{STG}	-55 to +150		$^\circ C$

* Limited by maximum junction temperature

Thermal Performance

Parameter	Symbol	TO-220	ITO-220	Unit
Thermal Resistance - Junction to Case	$R\theta_{JC}$	0.43	2.6	°C/W
Thermal Resistance - Junction to Ambient	$R\theta_{JA}$	62.5		

Notes: Surface mounted on FR4 board $t \leq 10\text{sec}$

Electrical Specifications (Tc = 25°C unless otherwise noted)

Parameter	Conditions	Symbol	Min	Typ	Max	Unit
Static						
Drain-Source Breakdown Voltage	$V_{GS} = 0V, I_D = 250\mu A$	BV_{DSS}	900	--	--	V
Drain-Source On-State Resistance	$V_{GS} = 10V, I_D = 4.5A$	$R_{DS(ON)}$	--	1.13	1.4	Ω
Gate Threshold Voltage	$V_{DS} = V_{GS}, I_D = 250\mu A$	$V_{GS(TH)}$	2.0	--	4.0	V
Zero Gate Voltage Drain Current	$V_{DS} = 900V, V_{GS} = 0V$	I_{DSS}	--	--	10	μA
Gate Body Leakage	$V_{GS} = \pm 30V, V_{DS} = 0V$	I_{GSS}	--	--	± 100	nA
Forward Transconductance	$V_{DS} = 30V, I_D = 4.5A$	g_{fs}	--	10	--	S
Diode Forward Voltage	$I_S = 9A, V_{GS} = 0V$	V_{SD}	--	--	1.5	V
Dynamic^b						
Total Gate Charge	$V_{DS} = 720V, I_D = 9A, V_{GS} = 10V$	Q_g	--	65	--	nC
Gate-Source Charge		Q_{gs}	--	11	--	
Gate-Drain Charge		Q_{gd}	--	23	--	
Input Capacitance	$V_{DS} = 25V, V_{GS} = 0V, f = 1.0\text{MHz}$	C_{iss}	--	2324	--	pF
Output Capacitance		C_{oss}	--	184	--	
Reverse Transfer Capacitance		C_{rss}	--	29	--	
Switching^c						
Turn-On Delay Time	$V_{GS} = 10V, I_D = 9A, V_{DD} = 450V, R_G = 25\Omega$	$t_{d(on)}$	--	61	--	nS
Turn-On Rise Time		t_r	--	49	--	
Turn-Off Delay Time		$t_{d(off)}$	--	318	--	
Turn-Off Fall Time		t_f	--	100	--	
Reverse Recovery Time	$V_{GS} = 0V, I_S = 9A,$	t_{fr}	--	470	--	nS
Reverse Recovery Charge	$di_F/dt = 100A/\mu s$	Q_{fr}	--	4.9	--	μC

Notes:

1. Repetitive Rating: Pulse Width Limited by Maximum Junction Temperature
2. $V_{DD} = 50V, I_{AS} = 9A, L = 20\text{mH}, R_G = 25\Omega, \text{Starting } T_J = 25^\circ\text{C}$
3. $I_{SD} \leq 9A, di/dt \leq 200A/\mu S, V_{DD} \leq BV, \text{Starting } T_J = 25^\circ\text{C}$
4. Pulse test: pulse width $\leq 300\mu S, \text{duty cycle } \leq 2\%$
5. b For design reference only, not subject to production testing.
6. c Switching time is essentially independent of operating temperature.

Electrical Characteristics Curve ($T_c = 25^\circ\text{C}$, unless otherwise noted)

Output Characteristics

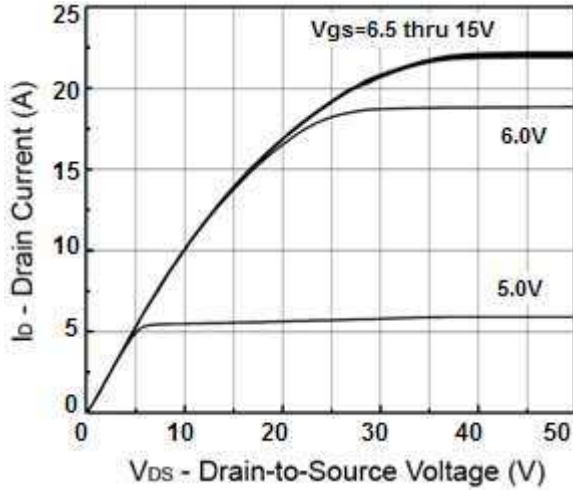

Transfer Characteristics

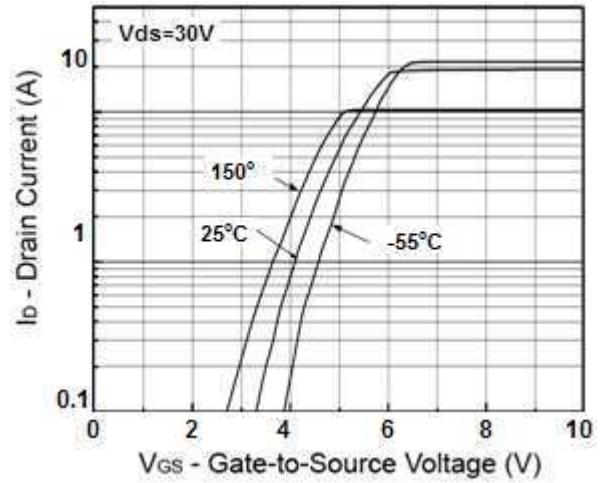

On-Resistance vs. Drain Current

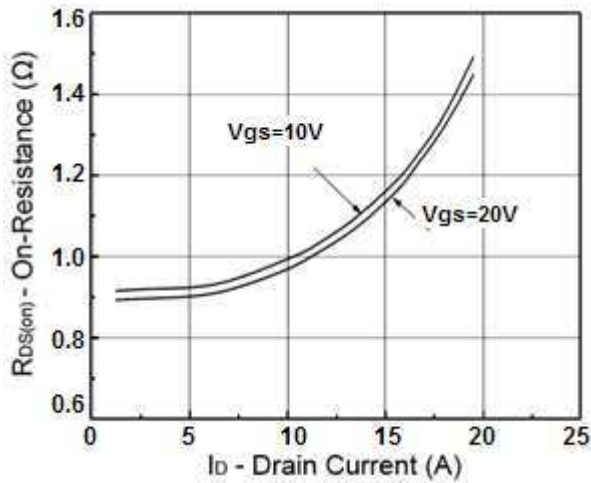

Gate Charge

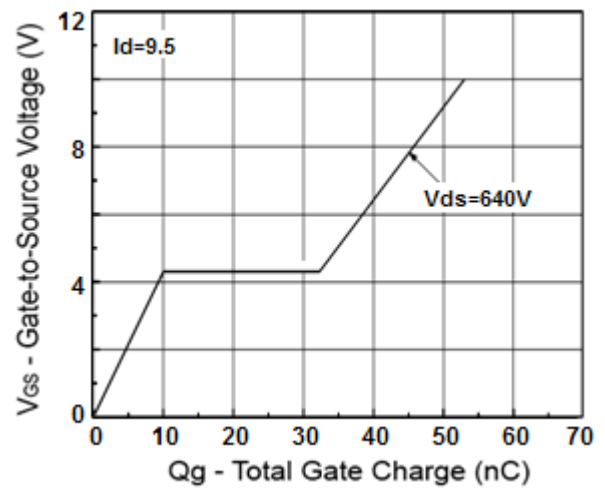

On-Resistance vs. Junction Temperature

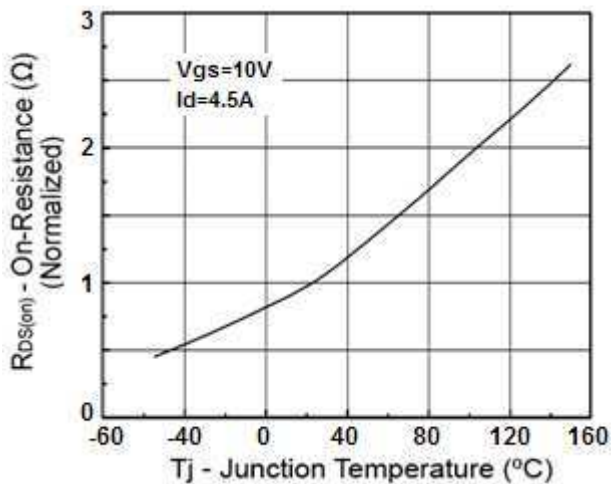

Source-Drain Diode Forward Voltage

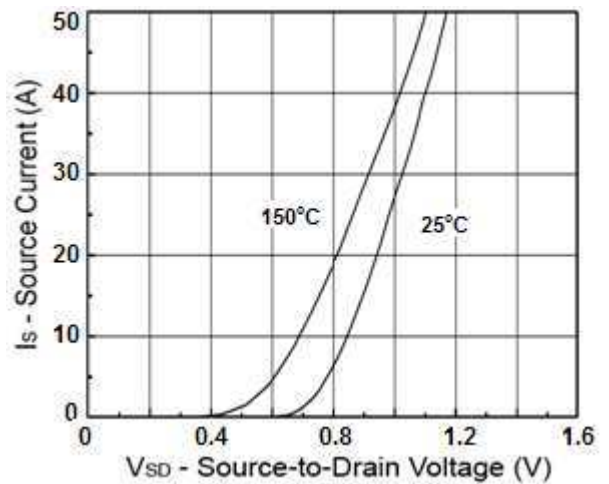

Electrical Characteristics Curve ($T_a = 25^\circ\text{C}$, unless otherwise noted)

Drain Current vs. Case Temperature

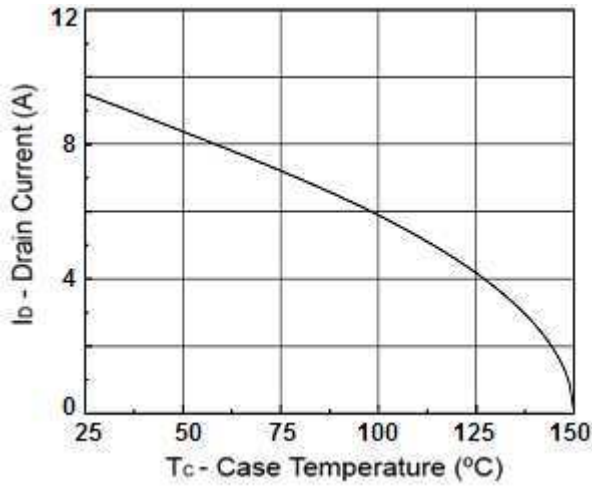

BV_{DSS} vs. Junction Temperature

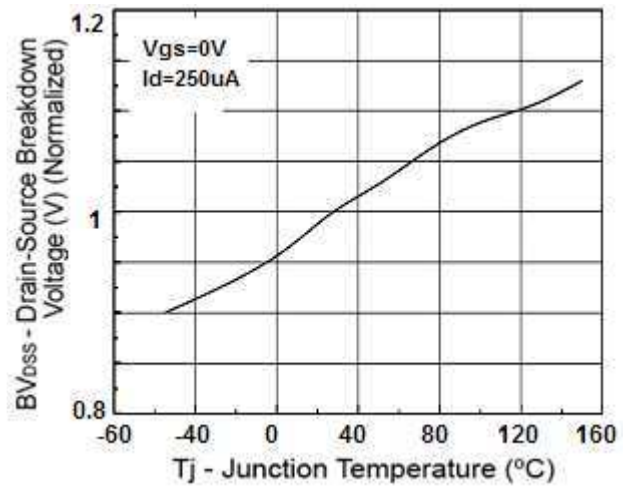

Maximum Safe Operating Area

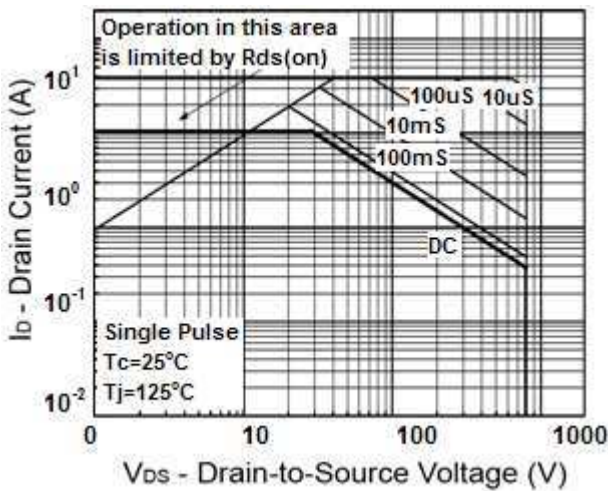

Capacitance vs. Drain-Source Voltage

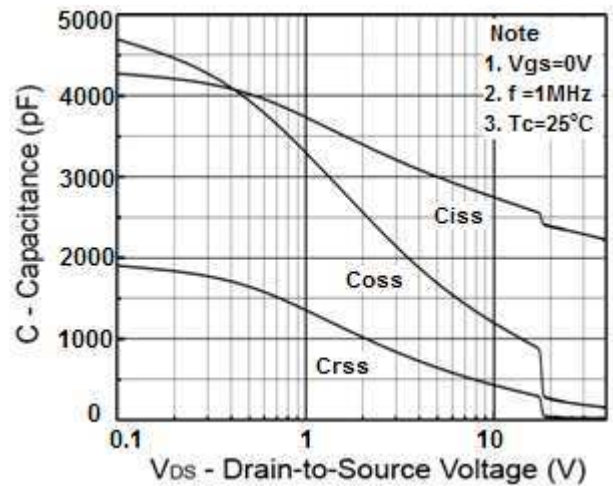

Maximum Safe Operating Area (ITO-220)

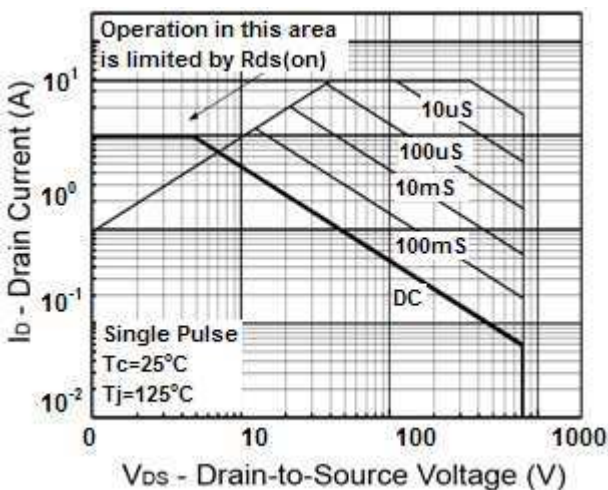

Electrical Characteristics Curve ($T_a = 25^\circ\text{C}$, unless otherwise noted)

Normalized Thermal Transient Impedance, Junction-to-Ambient

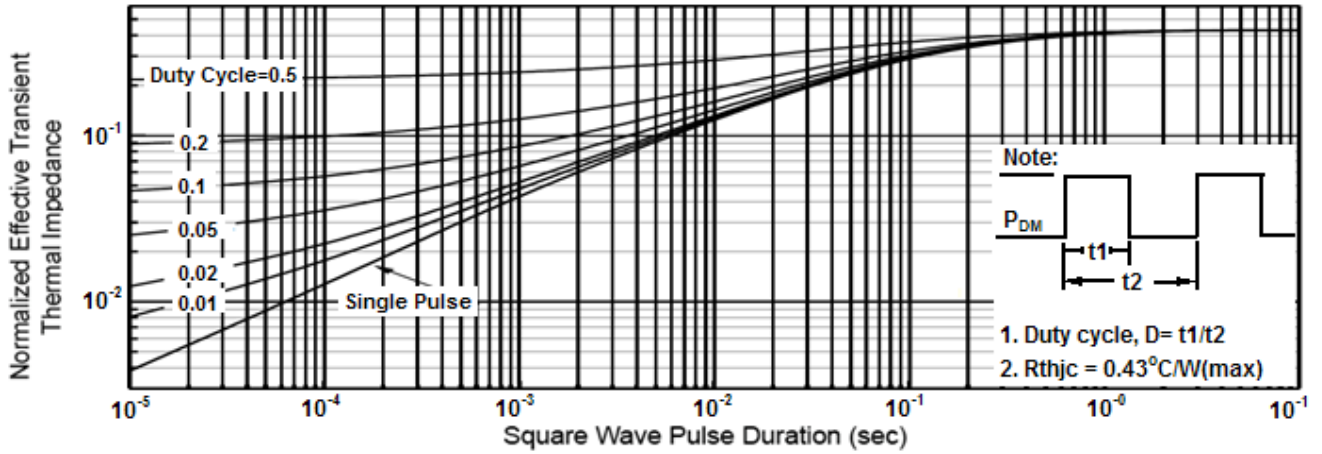

Normalized Thermal Transient Impedance, Junction-to-Ambient(ITO-220)

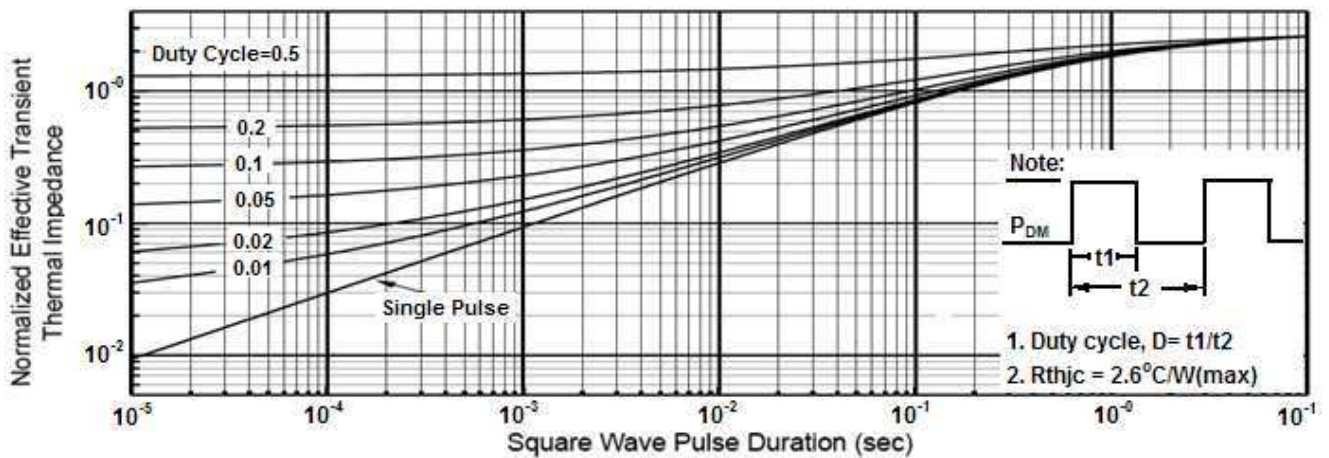

Gate Charge Test Circuit & Waveform

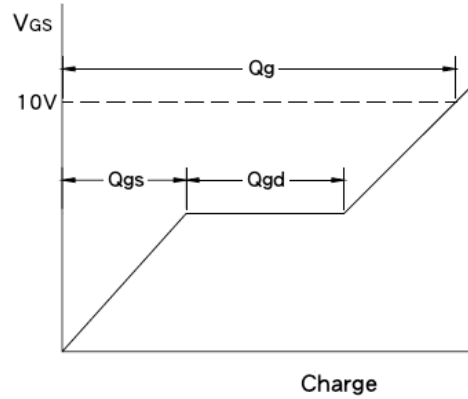
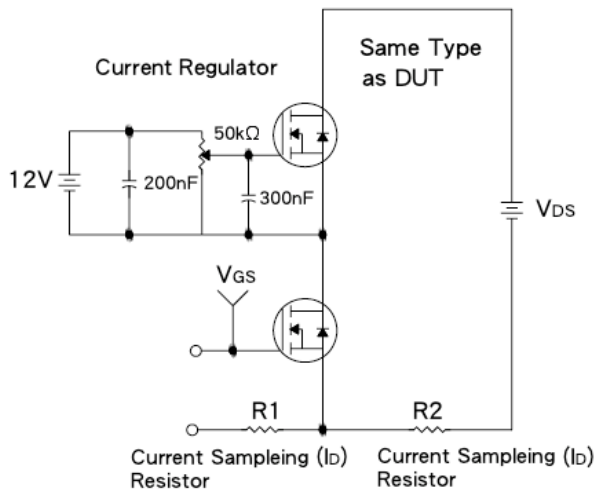

Resistive Switching Test Circuit & Waveform

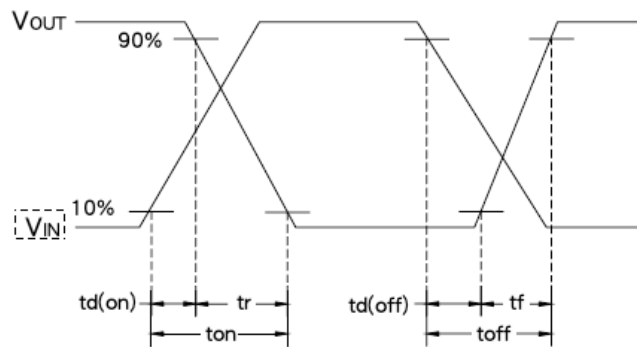
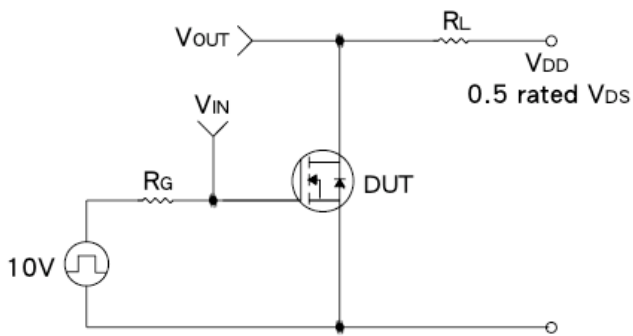

EAS Test Circuit & Waveform

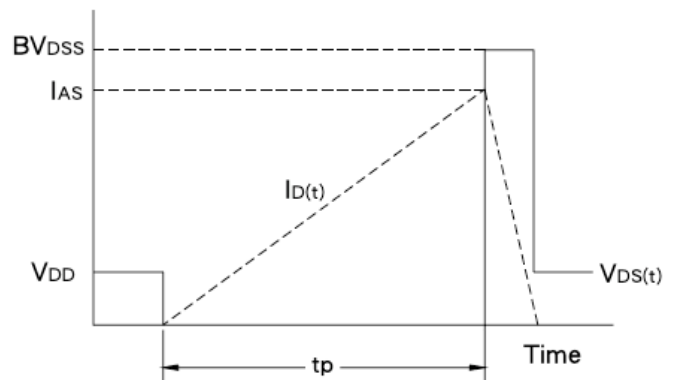
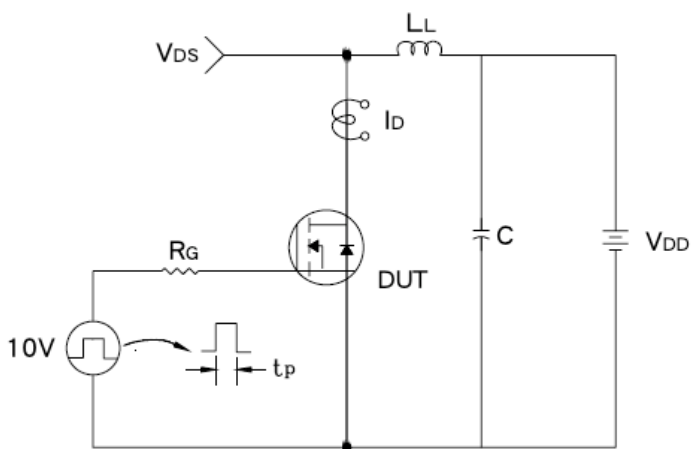

Diode Reverse Recovery Time Test Circuit & Waveform

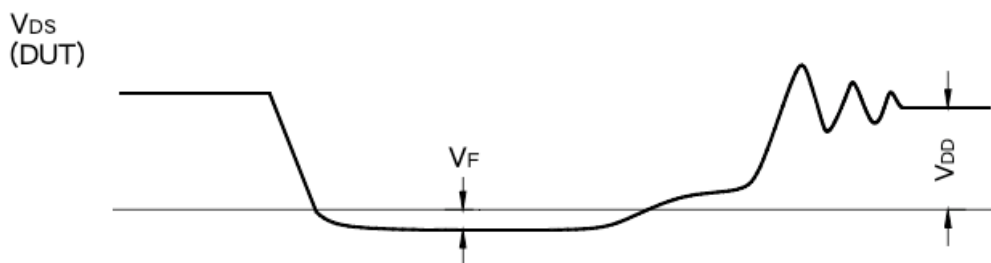
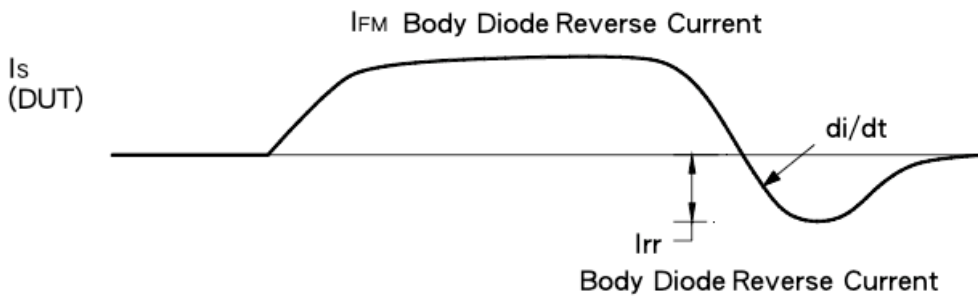
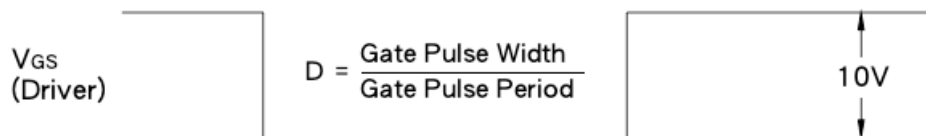
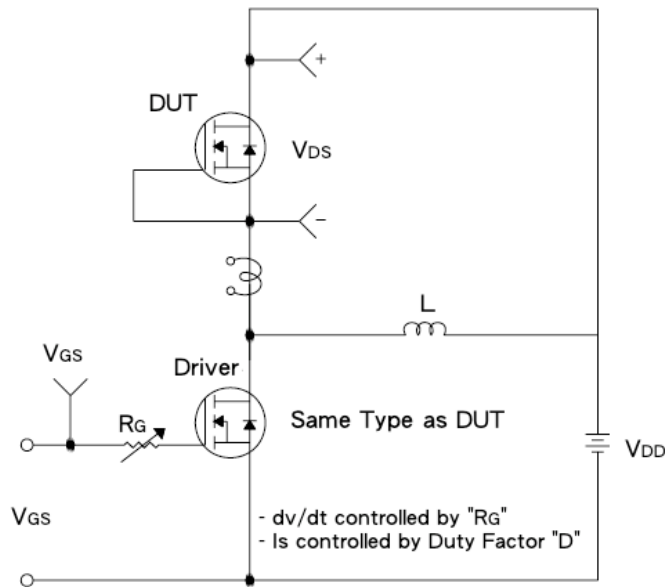

TO-220 Mechanical Drawing

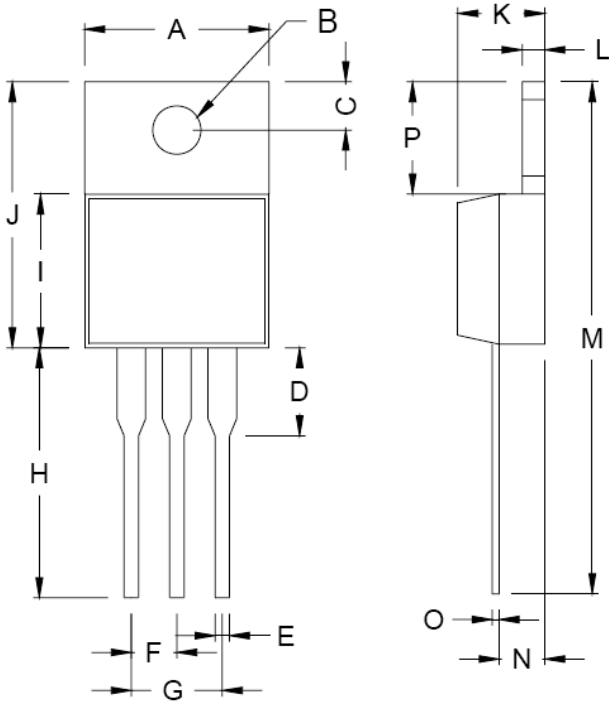

TO-220 DIMENSION				
DIM	MILLIMETERS		INCHES	
	MIN	MAX	MIN	MAX
A	10.00	10.50	0.394	0.413
B	3.74	3.91	0.147	0.154
C	2.44	2.94	0.096	0.116
D	--	6.35	--	0.250
E	0.38	1.10	0.015	0.043
F	2.34	2.71	0.092	0.107
G	4.69	5.43	0.185	0.214
H	12.70	14.73	0.500	0.580
I	8.38	9.38	0.330	0.369
J	14.22	16.51	0.560	0.650
K	3.55	4.82	0.140	0.190
L	1.16	1.40	0.046	0.055
M	27.70	29.62	1.091	1.166
N	2.03	2.92	0.080	0.115
O	0.25	0.61	0.010	0.024
P	5.84	6.85	0.230	0.270

ITO-220 Mechanical Drawing

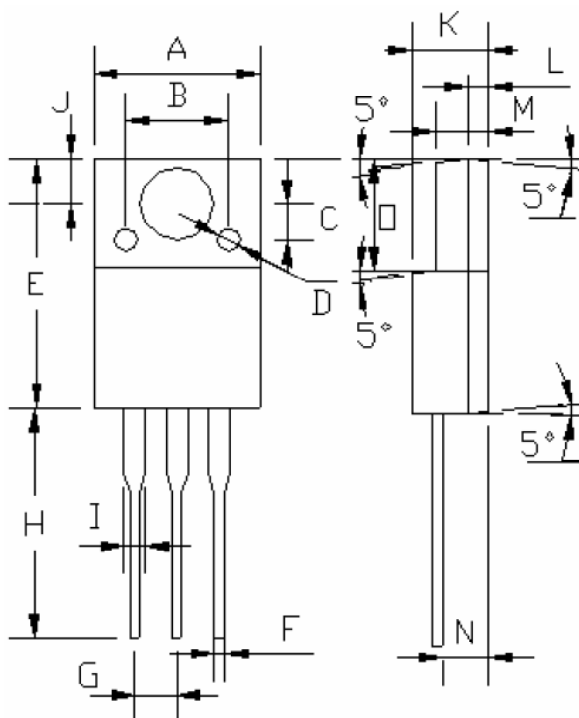

ITO-220 DIMENSION				
DIM	MILLIMETERS		INCHES	
	MIN	MAX	MIN	MAX
A	10.04	10.07	0.395	0.396
B	6.20 (typ.)		0.244 (typ.)	
C	2.20 (typ.)		0.087 (typ.)	
D	§ 1.40 (typ.)		§ 0.055 (typ.)	
E	15.0	15.20	0.591	0.598
F	0.52	0.54	0.020	0.021
G	2.35	2.73	0.093	0.107
H	13.50	13.55	0.531	0.533
I	1.11	1.49	0.044	0.058
J	2.60	2.80	0.102	0.110
K	4.49	4.50	0.176	0.177
L	1.15 (typ.)		0.045 (typ.)	
M	3.03	3.05	0.119	0.120
N	2.60	2.80	0.102	0.110
O	6.55	6.65	0.258	0.262

Notice

Specifications of the products displayed herein are subject to change without notice. TSC or anyone on its behalf, assumes no responsibility or liability for any errors or inaccuracies.

Information contained herein is intended to provide a product description only. No license, express or implied, to any intellectual property rights is granted by this document. Except as provided in TSC's terms and conditions of sale for such products, TSC assumes no liability whatsoever, and disclaims any express or implied warranty, relating to sale and/or use of TSC products including liability or warranties relating to fitness for a particular purpose, merchantability, or infringement of any patent, copyright, or other intellectual property right.

The products shown herein are not designed for use in medical, life-saving, or life-sustaining applications. Customers using or selling these products for use in such applications do so at their own risk and agree to fully indemnify TSC for any damages resulting from such improper use or sale.