

**Small Signal Diode**

SOT-323

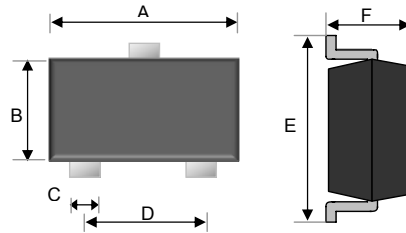
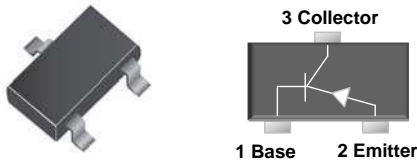

**Features**

- ✧ Epitaxial planar die construction
- ✧ Surface device type mounting
- ✧ Moisture sensitivity level 1
- ✧ Matte Tin(Sn) lead finish with Nickel(Ni) underplate
- ✧ Pb free version and RoHS compliant
- ✧ Green compound (Halogen free) with suffix "G" on packing code and prefix "G" on date code

**Mechanical Data**

- ✧ Case : SOT-323 small outline plastic package
- ✧ Terminal: Matte tin plated, lead free., solderable per MIL-STD-202, Method 208 guaranteed
- ✧ High temperature soldering guaranteed: 260°C/10s
- ✧ Weight : 0.005gram (approximately)

Dimensions	Unit (mm)		Unit (inch)	
	Min	Max	Min	Max
A	1.90	2.10	0.075	0.083
B	1.15	1.35	0.045	0.053
C	0.25	0.35	0.010	0.014
D	1.20	1.40	0.047	0.055
E	2.00	2.20	0.079	0.087
F	0.80	1.00	0.031	0.039

**Ordering Information**

Package	Part No.	Packing	Marking
SOT-323	BC807-16W RF	3K / 7" Reel	5CR
SOT-323	BC807-25W RF	3K / 7" Reel	5CS
SOT-323	BC807-40W RF	3K / 7" Reel	5CT
SOT-323	BC807-16W RFG	3K / 7" Reel	5CR
SOT-323	BC807-25W RFG	3K / 7" Reel	5CS
SOT-323	BC807-40W RFG	3K / 7" Reel	5CT

**Suggested PAD Layout**

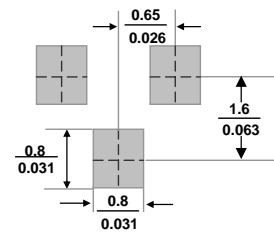

**Maximum Ratings and Electrical Characteristics**

Rating at 25°C ambient temperature unless otherwise specified.

**Maximum Ratings**

Type Number	Symbol	Value	Units
Power Dissipation	$P_D$	200	mW
Collector-Base Voltage	$V_{CBO}$	50	V
Collector-Emitter Voltage	$V_{CEO}$	45	V
Emitter-Base Voltage	$V_{EBO}$	5	V
Collector Current	$I_C$	0.5	A
Thermal Resistance, Junction to Ambient	$R_{\theta JA}$	625	k/w
Junction and Storage Temperature Range	$T_J, T_{STG}$	-55 to + 150	°C

1) Transistor mounted on an FR4 printed-circuit board.

**Small Signal Diode**

**Electrical Characteristics**

Type Number		Symbol	Min	Max	Units
Collector-Base Breakdown Voltage	at- $I_C=10\mu A$	$V_{(BR)CBO}$	50	-	V
Collector-Emitter Breakdown Voltage	at- $I_C=10mA$	$V_{(BR)CEO}$	45	-	V
Emitter-Base Breakdown Voltage	at- $I_C=10\mu A$	$V_{(BR)EBO}$	5	-	V
Collector Cut-off Current	at- $V_{CB}=20V$ at- $V_{CB}=20V, T_J=150^\circ C$	$I_{CBO}$	-	100 5	nA $\mu A$
Emitter Cut-off Current	at- $V_{EB}=5V$	$I_{EBO}$	-	100	nA
DC Current Gain	at- $V_{CE}=1V, -I_C=100mA$	$h_{FE}$	100	250	-
	-16W		160	400	-
	-25W -40W		250	600	-
	at- $V_{CE}=1V, -I_C=500mA$		40		
Collector-Emitter saturation voltage	at- $I_C=500mA$ $I_B=50mA$	$V_{CE(sat)}$	-	0.7	V
Transition frequency	$V_{CE}=5V$ $I_C=10mA$ $f=100MHz$	$f_T$	80	-	MHz

**Tape & Reel specification**

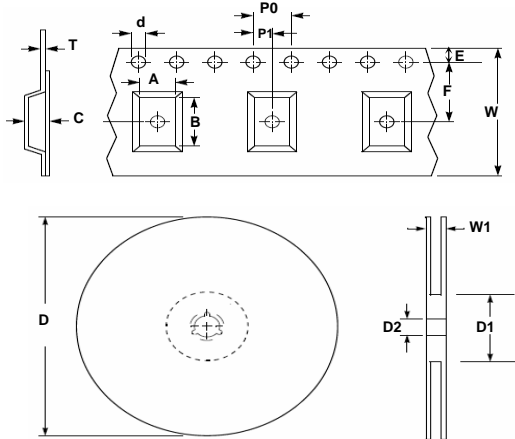
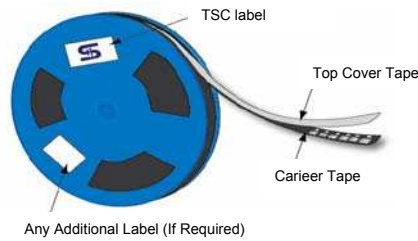

Item	Symbol	Dimension(mm)
Carrier width	A	3.15 ±0.10
Carrier length	B	2.77 ±0.10
Carrier depth	C	1.22 ±0.10
Sprocket hole	d	1.50 ± 0.10
Reel outside diameter	D	178 ± 1
Reel inner diameter	D1	55 Min
Feed hole width	D2	13.0 ± 0.20
Sprocket hole position	E	1.75 ±0.10
Punch hole position	F	3.50 ±0.05
Sprocket hole pitch	P0	4.00 ±0.10
Embossment center	P1	2.00 ±0.05
Overall tape thickness	T	0.229 ±0.013
Tape width	W	8.10 ±0.20
Reel width	W1	12.30 ±0.20

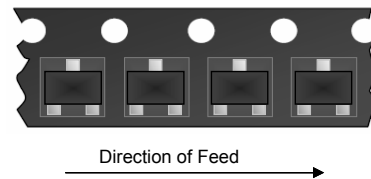

**Small Signal Diode**

**Rating and Characteristic Curves**

**Total power dissipation  $P_{tot} = f(T_S)$**

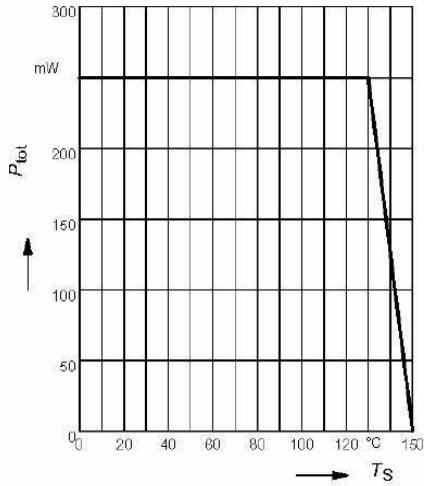

**Permissible Pulse Load  $R_{thJS} = f(t_p)$**

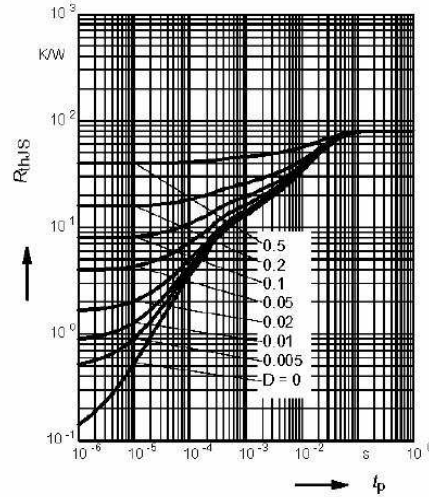

**Permissible Pulse Load**

$P_{totmax} / P_{totDC} = f(t_p)$

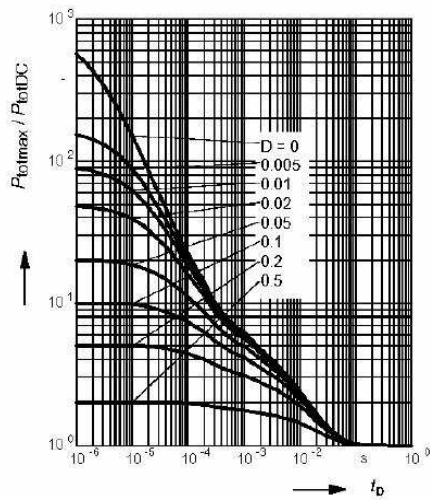

**Collector cutoff current  $I_{CBO} = f(T_A)$**

$V_{CB} = 25V$

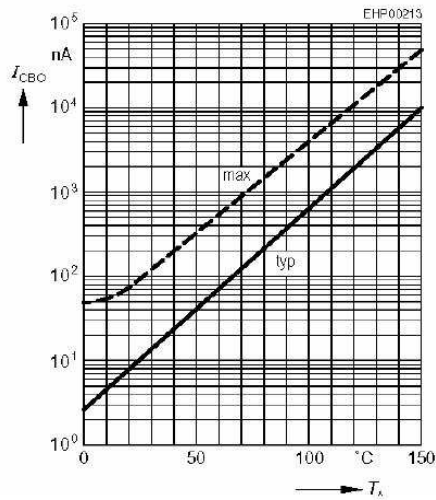

**Small Signal Diode**

**Rating and Characteristic Curves**

**DC current gain  $h_{FE} = f(I_C)$**

$V_{CE} = 1V$

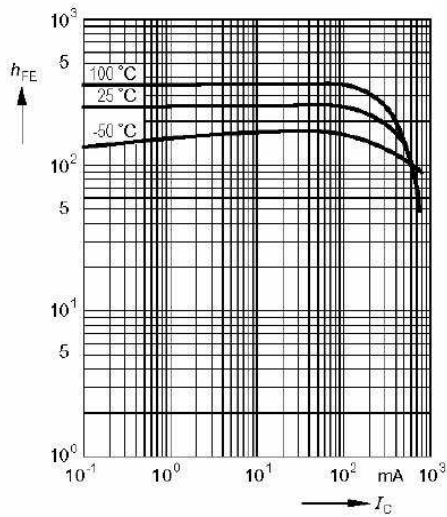

**Transition frequency  $f_T = f(I_C)$**

$V_{CE} = 5V$

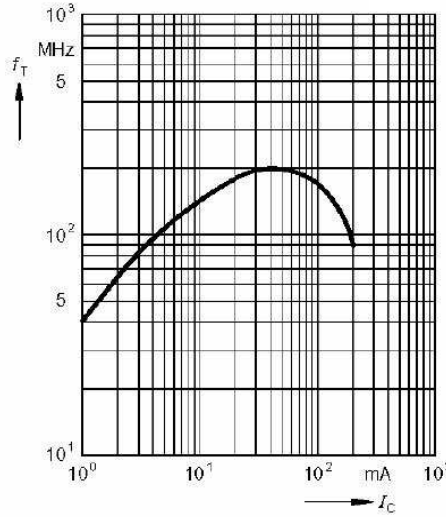

**Base-emitter saturation voltage**

$I_C = f(V_{BEsat}), h_{FE} = 10$

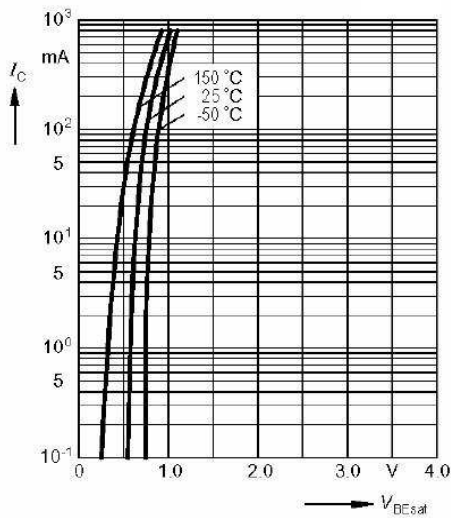

**Collector-emitter saturation voltage**

$I_C = f(V_{CEsat}), h_{FE} = 10$

